

Historic, Archive Document

Do not assume content reflects current scientific knowledge, policies, or practices.

THOS. J. GREY CO.
THE SEEDSMEN



LIBRARY
RECEIVED
★ FEB 6 1929 ★
U. S. Department of Agriculture

16 SOUTH MARKET ST.
✿ BOSTON-MASS. ✿

IMPORTANT TO CUSTOMERS

ORDER EARLY.—We would suggest that customers send us their orders as soon as possible after receiving this catalogue, and thus avoid the rush of the planting season. It frequently happens that some articles are not in store when orders are received. In such cases we forward such as are ready, and the balance as soon as possible.

STOCK SEED.—A large part of our seeds are grown for us on contract by special growers, from our own stock, and in locations best suited for their development. Others are secured from strictly reliable sources, and constant effort is made to secure only the best.

ADDRESS, ETC.—Give name of your post office, county and state, sign your name plainly; also specify means of conveyance preferred—whether by parcel post, express or freight.

FREE DELIVERY.—We will send by parcel post, to any part of the United States, all Vegetable and Flower Seeds quoted in this catalogue at packet, ounce, quarter-pound and half-pound rates, free of expense to the purchaser. All heavy seeds, including Peas, Beans, Corn, Clover Seed, Seed Grain, Roots, etc., are quoted at net prices at our store. Purchasers desiring these by mail are requested to remit an additional amount sufficient to cover postage, at parcel post rates according to zone. Allow two pounds in weight for each quart of Peas, Beans, or Corn. Particular attention is invited to this, as, when omitted, the cost of postage will be deducted from the amount received.

SHIPPING.—We deliver free to Express, Railroad or Boat. All goods travel at the buyer's risk, our responsibility ceases when we take the carrier's receipt. If goods are damaged so sign for them and enter claim with the carrier at once.

BAGS AND PACKING.—No charge is made for boxes or packing on anything, except Flower Pots, Nursery Stock and Hotbed Sash, and this at cost only. Cloth Bags are charged for at cost and if returned in good condition charges prepaid, will be credited at price charged.

REMITTANCES.—May be made by Express Money Order, P. O. Money Order or Bank Draft; if stamps or cash send in a Registered Letter. Parties having no account with us—who order goods without remittance—must furnish satisfactory references. Boston preferred.

PRICES. All prices are net without discount and subject to change without notice.

TERMS ARE NET CASH.—All bills on which short credits are allowed are due the first of the month succeeding the date of the purchase.

WE ARE THE ONLY HOUSE IN NEW ENGLAND carrying a full stock of Seeds, Tools, Implements and Repairs for the wants of the **RETAIL TRADE EXCLUSIVELY.**

GARDENERS' AND FARMERS' SITUATIONS.—We have at all times the names of practical gardeners and farm managers in want of situations on our books. If parties desiring such will write us, we shall be glad to put them in communication with men whom we deem suitable. To aid us in making a selection we ask full particulars. We make no charge for this service.

 We give no warranty, expressed or implied, as to quality, description, productiveness, or any other matter of any Seeds, Bulbs or Plants we send out, and will not be in any way responsible for the crop. If the purchaser does not accept the goods on these terms, they must at once be returned

THOMAS J. GREY COMPANY THE SEEDSMEN

16 SOUTH MARKET STREET :: BOSTON, MASS.

R. E. MONTGOMERY, President

J. P. A. GUERINEAU, Treasurer

PETER M. MILLER, Secretary

PARCEL POST RATES

Packages must not exceed 84 inches in length and girth combined. Seventy pounds is the limit of weight in the first, second and third zones. Fifty pounds is the limit of weight in all other zones.

1st zone—7c. for first pound and 1c. for each additional pound or fraction.	5th zone—9c. for first pound and 6c. for each additional pound or fraction.
2d zone—7c. for first pound and 1c. for each additional pound or fraction.	6th zone—10c. for first pound and 8c. for each additional pound or fraction.
3d zone—8c. for first pound and 2c. for each additional pound or fraction.	7th zone—12c. for first pound and 10c. for each additional pound or fraction.
4th zone—8c. for first pound and 4c. for each additional pound or fraction.	8th zone—14c. for first pound and 12c. for each additional pound or fraction.

Postage on seeds, bulbs, plants and roots of 8 ounces or less to all zones, is 1c. for each 2 ounces.

Postage on general merchandise of 8 ounces or less, to all zones, is 1½c. for each 2 ounces.

Flower Seed Novelties and Specialties for 1929

SEE PAGES 29 TO 62 FOR GENERAL LIST OF FLOWER SEEDS

ALSTROEMERIA

Lily-like perennials, fine for cutting, needs light protection in Winter; 2½ to 3 ft. high.

177 **HAEMANTHA.** Red, tipped green. Pkt. 75c.

178 **HAEMANTHA ROSEA.** Fine color. Pkt. \$1.00.

ANTIRRHINUM, GIANT

271 **ROCK'S WHITE.** A very large, pure white; its special value is as a greenhouse variety of proven merit. Pkt. 15c., ¼ oz. 50c.

273 **WELD PINK.** Beautiful salmon-pink, with darker shading in the throat. Specially recommended for the greenhouse. Pkt. \$1.00.

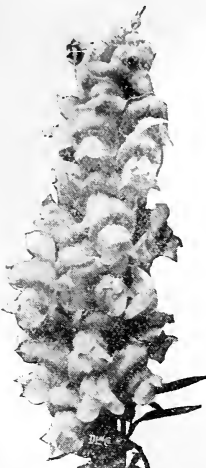

Antirrhinum, Giant

ANTIRRHINUM NANUM GRANDIFLORUM

The following varieties are very large flowering and exquisite in coloring. 15 to 18 inches high.

366 **MAJESTIC DELIGHT.** A fine semi-dwarf. Delicate salmon-pink shading to apricot, golden yellow center. Pkt. 35c.

367 **MATCHLESS.** (New.) Free flowering sort, brilliant apricot-buff with yellow center. Pkt. 15c.

See pages 30 and 31 for other varieties.

ASCLEPIAS

532 **INCARNATA.** Fine herbaceous plant, perfectly hardy; fine heads of reddish-pink flowers. 2½ ft. Pkt. 35c.

533 **INCARNATA ALBA.** A white variety of the above. 2½ ft. Pkt. 35c.



Tuberous Rooted Begonia

BEGONIA (Tuberous Rooted)

BLACKMORE & LANGDON'S SPECIAL STRAIN. Original packets. Pkt.

1142 **Double Finest Mixed.** \$1.00

1147 **Single Finest Mixed.** 1.00

1152 **Extra Frilled Finest Single Mixed.** ... 1.00

1183 **MARIEMONT BEDDER.** This is a beautiful variety originated on the estate of Mrs. T. J. Emery, Newport, R. I., where it is extensively used in beds and borders. It is the finest bedding variety grown, very compact, with small, reddish-brown foliage and a perpetual bloomer. The flowers are of the most brilliant scarlet and so freely produced that the foliage is almost hidden. If the plants are lifted in the Fall, cut back and taken into the house, they make one of the finest Winter bloomers. Pkt. 25c.

BROWALLIA

1253 **DEMISSA.** A free blooming annual; small blue flowers with white eye; also good as a pot plant. 1 ft. Pkt. 20c.

CANDYTUFT

1537 **PYRAMIDAL PERFECTION.** White. A giant variety of this popular flower. pyramidal habit. Fine for greenhouse growing. Pkt. 15c., ¼ oz. 60c.



Candytuft, Pyramidal Perfection

CINERARIA

MULTIFLORA GRANDIFLORA MAXIMA. A hybrid between "Multiflora nana" and "Grandiflora," having the large blooms of the grandiflora and the many flowers of the multiflora nana. 12 to 16 in. above the pot. Pkt. 1876 **Light Rose** \$1.00
1877 **Salmon Rose** 1.00
1878 **Carmine** 1.00
1879 **Dark Red** 1.00
1881 **Cornflower Blue** 1.00

MULTIFLORA NANA. A new Cineraria created by a Swiss florist. Makes a beautiful pot plant. Very compact growth, 10 inches above the pot. Leaves rather smaller than the grandiflora type of Cineraria. Flowers slightly more than one inch in diameter, with centers varying from yellow to brown. Pkt.
1911 **Dark Blue** \$0.75
1912 **Deep Red**75
1913 **Lavender**75
1914 **Light Blue**75
1916 **Pink**75
1917 **Rose**75
1918 **Mixed**75

DAHLIA

2197 **MERCKI.** A distinct garden Dahlia; a beautiful foliage plant as well as very free flowering; has mauve Cosmos-like flowers; easily raised from seed the first year. 2 ft. Pkt. 50c.

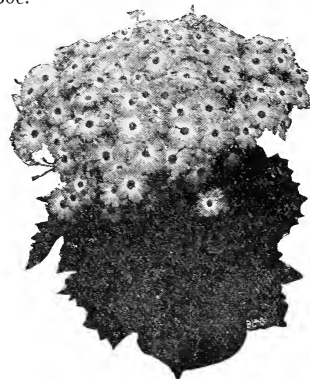

Cineraria

FLOWER SEED NOVELTIES AND SPECIALTIES FOR 1929—Continued

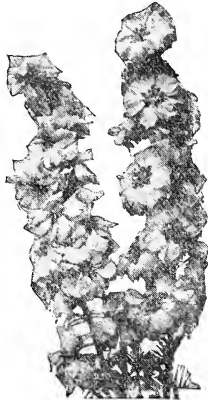

Delphinium

No. **DELPHINIUM**

2263 **EXQUISITEROSE.** An annual upright Larkspur. A deep rose color, several shades darker than the popular variety. Exquisite pink. Pkt. 25c., 1/2 oz. 70c.

DELPHINIUM

(PERENNIAL)

2312 **BLACKMORE & LANGDON'S PRIZE STRAIN.** Considered one of the finest strains in the world. Seed saved from the choicest varieties. Pkt. 50c.

DELPHINIUM

2367 **WREXHAM HYBRIDS "HOLLYHOCK DELPHINIUM."** A wonderful type of surpassing size and beauty, containing many new colors. A real exhibition variety. Pkt. 75c.

DIMORPHOTHECA

2576 **EKLONIS.** A new, large, white form of the African Marguerite. Plants grow about 2 ft. high. Flowers pure white, 2 1/2 to 3 inches across, with small blue center. Pkt. 25c.

EREMURUS

2639 **GOLD MEDAL HYBRIDS.** As a result of over 20 years crossing and re-crossing, many new and delightful colors and forms have been produced. These are all July flowering forms, perfectly hardy and like full sunshine, good but not too heavy a soil. 6 to 10 ft. Pkt. 50c.



Petunia, New Dwarf California Giants

GODETIA

2937 **NEW LAVENDER.** A beautiful single flowered annual of easy culture. A delicate lavender. Pkt. 20c., 1/2 oz. 35c.

HOLLYHOCK

No. **(DOUBLE)**
5006 **"EXQUISITE."** A new double fringed Hollyhock with very large flowers measuring 4 to 5 inches across; colors include rose, light rose, carmine, violet and dark purple, the petals being margined and blotched. Pkt. 25c.

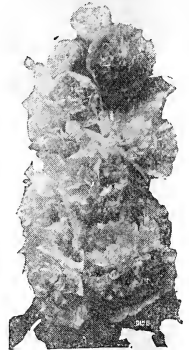

Double Hollyhock

5008 **IMPERATOR DOUBLE**

Flowers about 6 inches across; outer petals frilled. A deeply fringed rosette in center about 2 inches wide, resembling a crested Begonia. Assorted colors. Pkt. 35c.

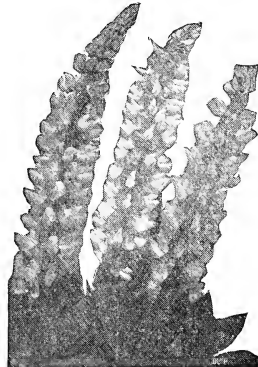

Lupinus

INULA

5116 **GOLDEN BEAUTY.** A new and distinct variety. The flowers are clear golden yellow, 2 or 3 inches across, borne on long, slender stems, making it most useful for cutting; plants grow to a height of 1 1/2 to 2 ft. Pkt. 20c.

LILIUM

5240 **REGALE (Regal Lily).** A large flowered lily, deep trumpet, slender foliage, very graceful. White, flushed yellow and deep brownish pink. Pkt. 50c.

LUPINUS POLYPHYLLUS

5362 **"ELLIOTT'S SWEET SCENTED."** A new strain of this hardy perennial with sweet-scented flowers. Mixed colors. Pkt. 20c.

LYCHNIS

5397 **CHALCEDONICA SALMONEA.** Hardy perennial; a salmon color of this popular favorite. 1 1/2 to 2 ft. Pkt. 20c.

PETUNIA

BALCONY. A variety specially recommended for window or porch boxes. Continuous bloomers, growing from 9 to 12 inches in height.

No.	Pkt.
6926 Blue	\$0.20
6297 Crimson20
6298 Rose20
6299 White20
6301 Mixed20

6362 **NEW DWARF CALIFORNIA GIANTS.** A very compact type of the Giant Petunia. Very large, well formed flowers. Specially recommended for pot culture. Throats well marked and veined. Pkt. 75c.

FLOWER SEED NOVELTIES AND SPECIALTIES FOR 1929—Continued



Primula

No. **POLYANTHUS, PRIMROSE**
 6759 **LARGE-FLOWERED BEDDING HYBRIDS**
 (Bunch Flowered Primrose). Extra choice strain, most carefully selected for habit, rich colors, and size of bloom. It is the finest strain procurable for bedding purposes; dwarf, upright habit. Pkt. 25c. 1-16 oz. \$1.25.

PRIMULA

6962 **MALACOIDES PINK BEAUTY.** A new variety with beautiful large rosy-pink flowers shading to mauve. Pkt. 30c.

6963 **MALACOIDES SUPERBA.** A new and improved variety, with larger flowers and better habit than the old sort. It is a deep rosy-pink in color, and makes a first-class greenhouse plant for Winter decorations. Pkt. 30c.

See pages 53 and 54 for separate colors and other varieties.

SCABIOSA

7182 **SHASTA.** An enormous flower. Pure white. Originated in California. Annual. Pkt. 50c.



Schizanthus

No. **SALVIA**

122 **SALVIA SPLENDENS "HARBINGER."** A very early dwarf growing Salvia. Dazzling scarlet flowers with dark foliage. Seed sown in February will produce flowering plants in June. Pkt. 40c.

STOCK

303 **IMPERIAL GOLDEN ROSE.** Early giant variety. Rich, light rose, golden sheen in center; very double and long stemmed. Pkt. 35c., 1/8 oz. \$1.50.

353 **APRICOT.** Special Forcing. A new color. Soft Apricot, delicately tinged pink. Grows 2 1/2 to 3 ft. Flowers large and fragrant. Pkt. 50c.



Salvia Splendens



Verbena

VERBENA (MAMMOTH)

8196 **ROSE QUEEN.** Originating from the well-known variety "Helen Wilmott" as a result of many years of selection, this superb new variety bears flowers of a lovely delicate rose, a tint somewhat paler than that of its parent. The individual blooms are unusually large, often exceeding 1 inch, and sometimes attaining 1 1/2 inches in diameter, and as many as 20 to 30 of them are often grouped on a single umbel. Pkt. 20c., 1/8 oz. 75c.

8197 **ROYALE HYBRIDA.** Rich deep royal blue. Very large flowers with light yellow centers. Pkt. 25c., 1/8 oz. \$1.00.

8202 **SCARLET QUEEN.** Flowers of the most vivid scarlet, similar to that of V. hybrida "Defiance," but with a large and distinct white eye which occupies almost half the surface of the corolla. The blooms often exceed an inch in diameter and succeed each other for a very long period, so that nothing finer can be conceived for striking bedding effects. Pkt. 20c., 1/8 oz. 60c.

8203 **SNOW QUEEN.** Giant flowered Verbena of a pure snow white color with umbels produced in great profusion. Pkt. 20c., 1/8 oz. 60c.

7202 **COLUMBARIA.** Hardy perennial variety. Low growing. Light green foliage, flowers pink. 2 to 2 1/2 inches across, borne on long, slender stems. A new color for perennial Scabiosa. Pkt. 50c.

SCHIZANTHUS WISETONENSIS

No. 7228 **PINK PEARL.** In every respect equal to its parent—the beautiful "Snowflake"—our novelty, while retaining the elegant pyramidal habit and luxuriant wealth of bloom of the latter, differs in the coloring of its flowers. In these the glistening white of the corolla is set off by a broad, rosy-pink margin on the wing and lip petals. Pkt. 25c.

7229 **ROSEUS COMPACTUS.** A fine greenhouse variety, compact, pyramidal shape; bright rose with red shading and golden blotch. Pkt. 60c.

WALLFLOWER

8333 **HAMLET.** A very large single variety, striking bright golden orange shade. Compact habit; a very fine bedder. Pkt. 40c.

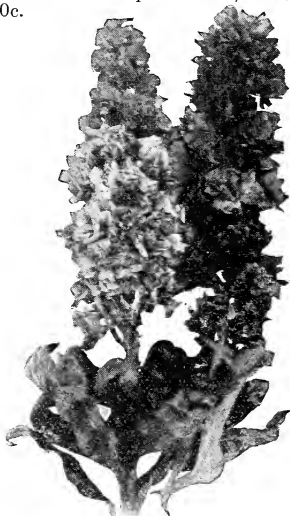

Wallflower

FLOWER SEED NOVELTIES AND SPECIALTIES FOR 1929—Continued

ZINNIA

GIANT DAHLIA FLOWERED. A double Zinnia of immense size.

No.			Pkt.
8380A.	Buttercup.	Deep creamy yellow.....	$\frac{1}{8}$ oz. 60c. \$0.20
8380B.	Canary Bird.	Delicate primrose.....	$\frac{1}{8}$ oz. 60c. .20
8381	Crimson Monarch.	$\frac{1}{8}$ oz. 60c. .20
8382	Dream.	Deep lavender.....	$\frac{1}{8}$ oz. 60c. .20
8383	Exquisite.	Light rose, deep center.....	$\frac{1}{8}$ oz. 60c. .20
8384	Golden State.	Orange yellow.....	$\frac{1}{8}$ oz. 60c. .20
8384A.	Illumination.	Deep rose self color.....	$\frac{1}{8}$ oz. 60c. .20
8384B.	Lemon Beauty.	Golden yellow or brown, a real pastel shade.....	$\frac{1}{8}$ oz. 60c. .20
8385	Meteor.	Glowing deep red.....	$\frac{1}{8}$ oz. 60c. .20
8385A.	Old Rose.	A real old rose color.....	$\frac{1}{8}$ oz. 60c. .20
8386	Oriole.	Orange and gold.....	$\frac{1}{8}$ oz. 60c. .20
8387	Polar Bear.	Pure white.....	$\frac{1}{8}$ oz. 60c. .20
8387A.	Purple Prince.	A deep purple.....	$\frac{1}{8}$ oz. 60c. .20
8388	Special Mixture.	$\frac{1}{8}$ oz. 60c. .20



Zinnia, Giant Dahlia-Flowered

New Giant Spencer Varieties of Sweet Peas

(See also pages 58 and 59 for standard sorts, and page 59 for Winter-flowering sorts)

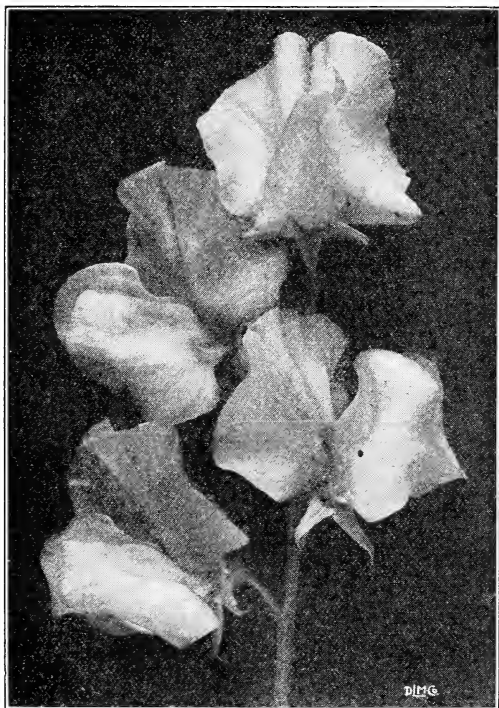

Giant Spencer Sweet Peas

No.			Pkt.
7509	CAMPFIRE.	Brightest scarlet.....	15c., oz. 60c.
7540	CORALLINE.	Orange cerise.....	Pkt. 10c., oz. 50c.
7551	DAFFODIL.	Deep cream B. S.....	Pkt. 10c., oz. 50c.
7556	DEFIANCE.	Orange-scarlet, sunproof.....	Pkt. 10c., oz. 50c.
7565	DOREEN.	Giant carmine.....	Pkt. 15c., oz. 60c.
7592	EDNA MAY.	Improved pure white.....	Pkt. 10c., oz. 50c.
7638	GEORGE SHAWYER.	Giant salmon rose.....	Pkt. 10c., oz. 50c.
7640	GIANT WHITE.	Pure white.....	Pkt. 10c., oz. 50c.
7645	GOLD CREST.	Orange, tinted salmon.....	Pkt. 20c., oz. 75c.
7647	GOLDEN GLORY.	Glowing orange.....	Pkt. 10c., oz. 50c.
7655	HAWLMARK SCARLET.	Fine color.....	Pkt. 10c., oz. 50c.
7661	JACK CORNWALL V. C.	Dark violet blue.....	Pkt. 10c., oz. 50c.
7679	JOAN RYDER.	Extra white B. S.....	Pkt. 10., oz. 50c.
7727	MARY PICKFORD.	Dainty cream-pink suffused salmon.....	Pkt. 20c., oz. 75c.
7734	MATCHLESS.	Cream color.....	Pkt. 10c., oz. 50c.
7735	MELBA.	Salmon.....	Pkt. 15c., oz. 60c.
7737	MERMAID.	Rich true lavender.....	Pkt. 25c., oz. 85c.
7741	MRS. ARNOLD HITCHCOCK.	Pale pink flushed salmon.....	Pkt. 10c., oz. 50c.
7882	WEMBLEY.	Lavender suffused plumbago blue.....	Pkt. 15c., oz. 60c.
7886	YOUTH.	White edged delicate pink.....	Pkt. 15c., oz. 60c.

EARLY FLOWERING SPENCER
SWEET PEASC7891 **MIXTURE** of many varieties. Pkt. 15c., oz. 50c.,
 $\frac{1}{4}$ lb. \$1.50.WE ARE HEADQUARTERS FOR THE FINEST LAWN GRASSES, FERTILIZERS, SPRAYING MATERIAL,
INTERNATIONAL HARVESTER CO.'S LINE OF IMPLEMENTS, PLOWS, ETC.

Specialties in Vegetable Seeds

PEDIGREE ASPARAGUS

MARY WASHINGTON. The best high producing, tender, green Asparagus for market and home use. It is earlier, produces more, has larger stalks, possesses highest rust resistance and will net a great deal more money per acre than the Martha Washington. We have a limited supply of carefully selected two-year-old roots. \$3.25 per 100, \$30.00 per 1000. Seed, pkt. 25c., oz. \$1.50, ¼ lb. \$5.00.

BEANS

ABUNDANCE. An extra early variety, producing a heavy crop of long, stringless pods of excellent flavor. For forcing in the greenhouse during Winter it cannot be surpassed. Pt. 50c., qt. 90c.

MASTERPIECE STRINGLESS BUSH. An extremely prolific, quick growing variety. The plants are unusually strong and bear long, straight, fleshy pods which are tender and delicious as well as handsome. A fine variety for exhibition and for those who demand quality. Pt. 75c., qt. \$1.25.

WEBBER WAX, or "CRACKERJACK." A high quality, flat podded, stringless variety of the season of Wardwell's Kidney Wax. Pods 6 to 6½ inches long, quite broad and uniformly curved, fleshy, stringless and brittle, with little fibre. Plant more vigorous and productive than Wardwell's. Color of pod is a decided bright yellow. Pt. 45c., qt. 80c.

BEEF

EARLY WONDER. The most perfect model of an extra early round Beet. The flesh is deep blood-red crimson. It is an ideal all season Beet, for while it grows a nice size Beet early, it retains its tender quality throughout the season. Pkt. 10c., oz. 30c., ¼ lb. \$1.00.

CROSBY'S EGYPTIAN. Selected. Arlington Grown. One of the earliest dark-leaved varieties; fine quality. Pkt. 15c., oz. 75c., ¼ lb. \$2.50, lb. \$8.00.

CABBAGE

CHINESE WONG BOK. This is the famous Chinese Celery Cabbage. It has wide midribs at the base and merges into crisp, tender leaves at the top, the whole being very compact and heavy. It blanches to almost clear white. The culture for Wong Bok is the same as for late Cabbage. When well grown the plants should be blanched by tying loosely with burlap. Pkt. 10c., oz. 60c.

THE GOLDEN ACRE. A new Cabbage, head measuring 9 inches in diameter; 10 days earlier than Copenhagen Market and more compact. Pkt. 25c., oz. \$1.50.

CARROT

DANVERS HALF-LONG IMPROVED. Special strain, Grown for us by a leading market gardener in Danvers. Pkt. 15c., oz. 75c., ¼ lb. \$2.75.

CELERY

GIANT PASCAL (Arlington grown). This is the most profitable Celery for Fall or Winter use, the stalks being broad, thick, solid, crisp and of rich, nutty flavor. This strain is remarkably free from soft, pithy stalks. Pkt. 25c., oz. \$2.00.

GOLDEN PLUME. An improved strain of Golden Self-Blanching; the plants are of strong growth and produce thick and heavy stalks of excellent crisp and nutty flavor. It is considered by many gardeners the best of all early varieties. Pkt. 25c., oz. \$1.50, ¼ lb. \$5.00.

NEWARK MARKET. The plants are strong and stocky with green foliage showing a slight tinge of yellow in the inner leaves. The stalks are very large and heavy, broad, crisp, solid, tender and of a most excellent nutlike flavor. Free from rust. Pkt. 25c., oz. \$2.50.

EASY BLANCHING. A comparatively new early variety recommended for both the home and market garden. The plants make a rapid and vigorous growth, producing rather thick, solid stalks of excellent quality and rich, nutty flavor. Pkt. 25c., oz. \$2.00

CORN, SWEET

GOLDEN SUNSHINE. The earliest of the Golden Bantam type, maturing a week to ten days earlier than that variety; more dwarf in habit than Bantam, with ears 6½ inches long, containing 12 rows of broad, yellow, sweet grains; especially desirable for its extreme earliness. Pt. 30c., qt. 50c., pk. \$3.50.

LETTUCE

MAY KING (*Selected strain*). As a Lettuce for greenhouse forcing this is the best; the heads form very quickly and are firm and of fine quality. Pkt. 25c., oz. \$1.00, ¼ lb. \$3.50.

SUTTON'S SUPREME. A fine Lettuce of the Drum-head type, and a marked advance on other varieties of the same class. Attains a large size with a firm heart, which remains good for a long time before starting seed stems. Leaves prettily edged with red. Pkt. 25c.

MELON

COTTING'S HYBRID. A new greenhouse Melon, raised by Joseph Madden of Manchester, Mass. Flesh orange, oval-shaped, carries three to four Melons to plant, weight 5 to 6 pounds each. Awarded two Certificates of Merit by the North Shore Horticultural Society and first class Certificate of Merit by the Massachusetts Horticultural Society. Pkt. 50c.

SUTTON'S KING GEORGE. Fine forcing variety. A unique, bright salmon or scarlet-fleshed Melon of extraordinary thickness, surpassing that of any other variety; skin buff yellow and evenly netted. The plant is strong and short-jointed in habit; foliage large, dark and of great substance; shape oval. Pkt. 50c.

SUTTON'S SUPERLATIVE. Fruit of medium size, almost round and very beautifully netted. Flavor unusually rich, flesh scarlet, emerging into a beautiful green tint near the skin. Plant robust and sets fruit very freely. Pkt. 50c.

SPECIALTIES IN VEGETABLE SEEDS—Continued

ONION

AILSA CRAIG. A handsome variety. Globe-shaped, flesh white, with pale yellow skin. A favorite for exhibition. Pkt. 25c., oz. \$1.00.

CRANSTON'S EXCELSIOR. Handsome, globe-shaped variety, large solid with small neck, straw color; an exhibition variety. Pkt. 25c., oz. \$1.00.

DANVERS YELLOW GLOBE, SELECTED STRAIN. The finest type of this popular variety in the market. Grown for us by an Onion specialist in Danvers, Mass. Pkt. 25c., oz. \$1.00, ¼ lb. \$3.00.

GIGANTIC GIBALTAR. A handsome straw-colored Onion of enormous size, possessed of many sterling qualities. Grand for exhibition. Pkt. 25c., oz. \$1.00.

PEAS

HUNDREDFOLD. A splendid large-podded dwarf variety; the pods are 4 inches long and well filled with large deep green Peas of fine quality. The vines grow 16 to 18 inches high and very strong; this is one of the best dwarf early Peas for the home garden and market. Pt. 65c., qt. \$1.00, 4 qts. \$3.50.

LAXTON'S PROGRESS. This is the finest new early dwarf Pea Laxton has ever yet raised; wrinkled, averaging 9 to 10 peas in a pod. Pods dark green, height 18 to 24 in. Pt. \$1.00, qt. \$1.50. Stock imported.

SUTTON'S SUPER V. C. The largest podded Pea in existence, height from 5 to 6 ft., large pods of fine flavor and exhibition variety. Pt. \$1.00, qt. \$1.75.

THE BRITISHER PEAS. A prolific, strong growing variety with medium green foliage. Pods are perfectly straight, pointed at the ends, and of a medium green color, containing nine large, nicely flavored Peas. 4 ft. Main crop; wrinkled. Pt. \$1.00, qt. \$1.75.

PARSLEY

DOBBIE'S EXHIBITION. This Parsley has long been recognized as a standard exhibition sort. It is remarkable for its large, fine leaves and close habit. The seed offered has been saved from selected plants only, every one of which was a perfect specimen. Pkt. 25c., oz. 75c.

SQUASH

DES MOINES. It is a small, dark green, acorn-shaped Squash, almost black in color, with deep ridges, hard shell, dry meat, small seed cavity, usually about 6 inches long and 4 inches in diameter. When fully matured it is an excellent keeper, therefore one of the best for home garden. Pkt. 15c., oz. 50c., ¼ lb. \$1.50.

GIANT STRAIGHT NECK SUMMER.

This is a new type, produced by one of New England's leading market gardeners. By careful selection he has produced a type nearly double the size of any other Summer Squash. Despite its large size the flesh is rich and fine flavored. Its attractive appearance has made it popular with the market gardeners. We believe this new variety will eventually replace all other Summer varieties. Pkt. 25c., oz. 75c., ¼ lb. \$2.50, lb. \$9.00.

SPINACH

SAVOY BLIGHT-RESISTING. On account of its resistance to blight, the yield is often very large. A valuable variety to use for Fall sowing. Oz. 15c., ¼ lb. 35c.

SAVOY-LEAVED, LONG-STANDING. Darker green and more heavily crumpled than Bloomsdale; will stand ten days longer before bolting to seed. Oz. 15c., ¼ lb. 35c.

TOMATO

CROCKFORD'S ALASKA, or TRELIS. Without doubt the finest forcing Tomato on the market. Also the best for outdoors if grown on trellises. Rich deep color, solid flesh. Pkt. 50c.

GOLDEN PONDEROSA. A large golden yellow variety of excellent quality. Pkt. 15c., oz. 75c., ¼ lb. \$2.50.

LISTER'S EXCELSIOR. This variety is the result of a cross between Ailsa Craig and Lister's Prolific, one of the best for forcing or outdoor culture; a heavy cropper of good flavor and color. Original pkts. 35c.

LISTER'S PROLIFIC. This variety combines all the essential qualities of productiveness, size, flavor, and color, whether planted out or grown in greenhouse. The clusters of fruit are borne in great profusion, and are remarkable for the number they carry; smooth and of a rich scarlet color. Original pkts. 35c.

LISTER'S PROTECTION. A new variety—the best of Lister's productions. Color dark crimson, a heavy cropper, perfect in shape and size. Pkt. 75c.

MYSTIC BEAUTY, "CROCKFORD'S." A cross between Bonny Best and Alaska, fully as large as Bonny Best; ripens 10 days earlier and of a much deeper color. One of the best outdoor varieties. Should be grown on stakes. Seed limited. Pkt. 50c.

SCOTT'S ELLENBANK. A new variety, very large, cropper, carrying trusses from 3 to 4 lbs. One of the best Tomatoes for indoor or outdoor cultivation. Original pkts. 75c.

INOCULATE THIS
SEED WITH
MULFORD CULTURE

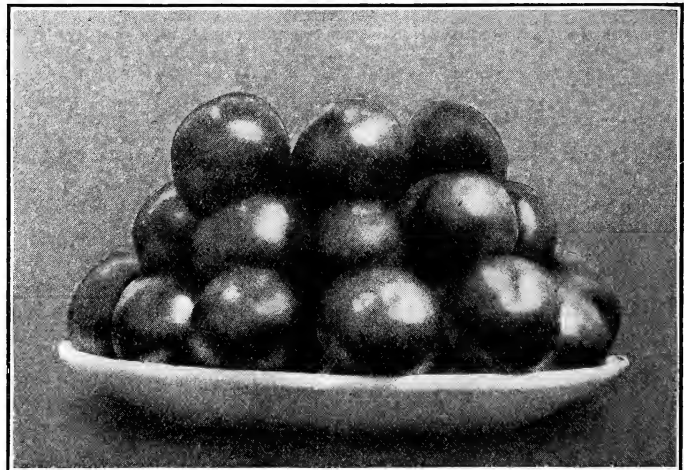

Crockford's Mystic Beauty



General List of Vegetable Seeds of Superior Quality



Awarded highest honors by the Massachusetts Horticultural Society for the best collection of vegetables, *i. e.* a silver medal in 1914 and 1915; and award of \$100 cash prize 1916, and Silver Medal 1919 and 1921.

Our Vegetable Seeds are of the highest standard. Grown for us by specialists,

Our Aim is Purity, Quality and Service.

SEEDS BY MAIL.

We deliver free of expense to the purchaser to any point in the United States all seeds quoted in this list at packet and once price.

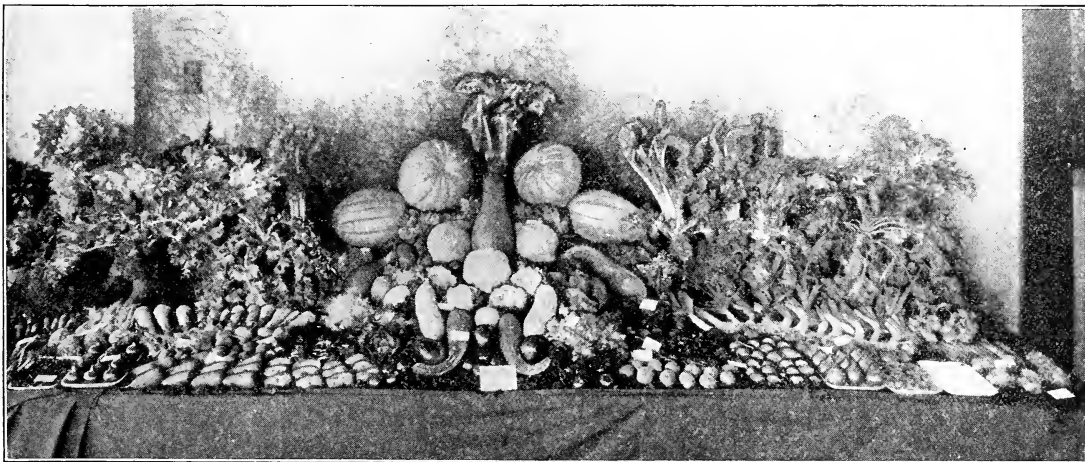

First Prize Collection of Vegetables at Massachusetts Horticultural Society—Autumn, 1928
Grown from our seed by Louis Vasseur, Supt., Mrs. Ellerton James Estate, Milton, Mass.

ARTICHOKE

Large Green Globe. The best variety; heads large and scales tender and excellent. Pkt. 25c., oz. \$1.00. | **Large Purple Globe.** Pkt. 25c., oz. \$1.00.

ASPARAGUS

One ounce will produce 200 plants.

A deep, rich, mellow soil is best adapted to the growth of Asparagus. It may be grown from seed or propagated by roots. Sow as early in the Spring as the ground will admit, in drills from 12 to 14 inches apart, and cover 1 inch deep; when the plants are well up, thin to 3 inches apart in the drills. Keep the plants free from weeds during Summer, and protect slightly during Winter.

The following Spring the roots will be ready to transplant into permanent beds; the roots should be set in rows 3 to 4 feet apart, and 1 foot apart in the rows; the crown of the root should be 4 to 6 inches below the surface of the ground. A fair crop may be expected the third year from the seed, or in one or two years when roots are used, according to the age of the roots planted. By planting two-year-old roots a fair crop may be obtained in one year, and after that a full crop every year.

Mary Washington. The latest improved variety. Very large shoots, early, vigorous and quite rust resistant. Pkt. 25c., oz. \$1.50, ¼ lb. \$5.00.

Martha Washington. Pkt 25c., oz. \$1.25, ¼ lb. \$4.00

Reading Giant. A variety of recent introduction, very large and free from blight. Pkt. 15c., oz. 50c., ¼ lb. \$1.75.

Asparagus Roots. Strong, two-year-old plants. \$2.00 per 100, \$18.00 per 1000.

Martha Washington. \$3.00 per 100, \$25.00 per 1000.

Mary Washington. Select roots. \$3.25 per 100, \$30.00 per 1000.

BEANS, Dwarf or Bush

One quart will plant 100 feet of drill. One and one-half bushels will plant one acre.

A warm, light soil is best adapted to the growth of Bush Beans, but they will do well in almost any situation unless it is very wet. Plant in rows 2 to 3 feet apart, dropping the beans 3 inches apart and covering 2 inches. Keep the ground free from weeds and cultivate often. Never disturb the vines when wet, as the pods will become rusty. All the varieties are tender and must not be planted until the soil is dry and warm.

If by mail add Parcel Post rate to cover postage. One quart weighs about 2 pounds. We furnish 20c. packets of all Beans except where noted.

WAX-PODDED VARIETIES

- Black Wax, Improved Prolific.** Early, very tender and of good quality. Pt. 35c., qt. 65c.
- Black Wax Pencil Pod.** Pods are long, pencil-like, very tender and brittle. Pt. 45c., qt. 85c.
- Brittle Wax.** The best of the round podded sorts, maturing early, prolific and bearing long stringless pods of excellent quality. Pt. 45c., qt. 85c.
- Burpee's Kidney Wax.** Of excellent quality. Pods long, stringless and free from rust. Pt. 45c., qt. 85c.
- Currie's Rust Proof.** Pods long, flat, straight and of a waxy-white color; quality excellent. Pt. 40c., qt. 75c.
- Davis' Kidney Wax.** Plant vigorous and of compact, upright growth, with pods extra long, straight, oval. Pt. 40c., qt. 75c.
- Golden Wax.** The standard variety for general use; pods long, broad and flat, very fleshy and of finest quality. Vines erect, hardy and productive. Pt. 45c., qt. 85c.
- Hudson Wax.** Very large brittle tender wax pods and very productive. Pt. 40c., qt. 75c.

- Round Pod Kidney Wax.** The pods are long, straight and extremely handsome. It is an exceedingly heavy bearer. Pt. 50c., qt. 90c.
- Sure Crop Stringless Wax.** A valuable new variety of dwarf wax Bean, very productive, rust-proof, and will stand a longer season of damp, wet weather than any other wax Bean. Pt. 50c., qt. 90c.
- Wardwell's Kidney Wax.** Very long, straight, tender pods. Vines large, vigorous and productive. Pt. 50c., qt. 90c.
- Webber Wax, or "Cracker Jack."** A high quality, flat-podded, stringless variety of the season. Pods 6 to 6½ inches long, quite broad and uniformly curved, fleshy, stringless and brittle, with little fibre. Pt. 45c., qt. 80c.

GREEN-PODDED VARIETIES

- Abundance.** An extra early variety, producing a heavy crop of long, stringless pods of excellent flavor. For forcing in the greenhouse during Winter it cannot be surpassed. Pt. 50c., qt. 90c.
- Bountiful.** Extra early, very prolific and long bearing. flat green pods, tender and stringless. Pt. 55c., qt. \$1.00.
- Broad Windsor (Sutton's White).** English variety very hardy. Pt. 55c., qt. \$1.00.
- Emperor of Russia.** Extremely prolific and highly esteemed where known. Pods long, slender and meaty. Medium early. French grown. Pkt. 25c., pt. 65c., qt. \$1.00.
- Full Measure.** Firm, tender, large, round pods, entirely stringless. Pt. 45c., qt. 80c.
- Giant Stringless, Green Pod.** Color deep green, very long, round, fleshy pods; very prolific and entirely stringless. Pt. 40c., qt. 75c.
- Goddard (Boston Favorite).** Fine shell Bean, pods large and highly colored. Pt. 40c., qt. 75c.
- Horticultural Dwarf.** A shell Bean of fine quality, early and productive. Pt. 40c., qt. 75c.
- Horticultural French's Dwarf.** An improved form of Dwarf Horticultural, producing long pods, beautifully splashed with bright crimson, heavy cropper. Pt. 50c., qt. 90c.
- Lima, Burpee's Improved Bush.** Best dwarf Lima beans, large and delicious. Pt. 45c., qt. 85c.
- Lima, Dreer's Bush.** Possesses all the good qualities of the Dreer's Pole Lima. Pt. 45c., qt. 80c.
- Lima, Fordhook Bush.** Pods and beans twice the size of Dreer's Lima, and earlier. Pt. 50c., qt. 90c.
- Lima, Henderson's Bush.** Pods and beans small; of excellent quality as a shell Bean. Pt. 40c., qt. 75c.
- Longfellow.** Long, straight, round, solid green pod, very early. Pt. 40c., qt. 75c.
- Low's Champion.** One of the best for snap or shell, with stringless, large, green, flat pods. Pt. 50c., qt. 85c.
- Masterpiece Stringless Bush.** An extremely prolific, quick growing variety. The plants are unusually strong and bear long, straight, fleshy pods which are tender and delicious as well as handsome. A fine variety for exhibition and for those who demand quality. Pt. 75c., qt. \$1.25.

INOCULATE THIS
SEED WITH
MULFORD CULTURE

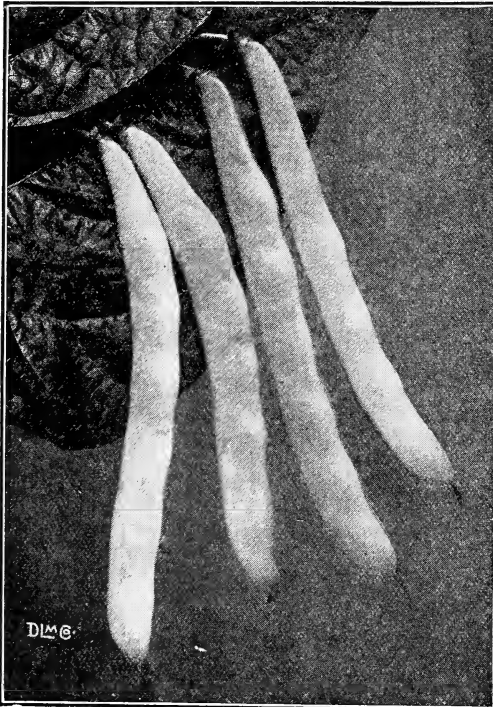

For Specialties in Beans, See Page V.

BEANS, Green-podded Varieties—Continued

- Plentiful, Sutton's.** A perfectly distinct dwarf Bean, bearing a most abundant crop of long, broad, straight pods which are practically stringless and of excellent flavor. One of the earliest varieties and one which we can confidently recommend for all gardens, and especially where forcing is practiced. Pt. 60c., qt. \$1.00.
- Refugee, Extra Early.** Pods green, round, quality excellent, extremely early and prolific. Pt. 35c., qt. 60c.
- Refugee, Late, or 1000 to 1.** Very tender and productive; the best variety for pickling. Pt. 40c., qt. 75c.
- Stringless Green Pod, Burpee's.** Extra early, prolific, round pod and stringless. Pt. 50c., qt. 90c.
- Triumph of the Frames.** The earliest French forcing variety. Pt. 70c., qt. \$1.40.
- Valentine, Black.** Long, round, solid pods; very early. Pt. 45c., qt. 80c.
- Valentine, Improved.** One of the earliest, pods round, thick and fleshy, of finest quality; leading market variety. Pt. 40c., qt. 75c.
- Wonder of France.** A valuable French variety for forcing. Pt. 75c., qt. \$1.40.

Beans, Pole or Running

One quart will plant about 150 hills

All under this head require poles 6 to 8 feet long and should not be planted until the ground is warm, as they are more tender than the dwarf varieties. Plant about the middle of May, if the season is suitable. The Lima Beans are very susceptible to cold and wet, and apt to rot in the ground, and should not be planted until all danger from frost is over, and the soil is dry and warm.



If by mail, add Parcel Post rate of 1 lb. for pint, 2 lbs. for quart, to cover postage.

- Burger's Stringless Green-Pod.** In some sections this is called White-seeded Kentucky Wonder. It is earlier and covers a longer season of productiveness. The pods, borne in clusters, average 6 to 8 in. in length. Pt. 45c., qt. 85c.
- Dutch Case-Knife.** Very early and prolific; fine shelled, green or dry. Pt. 40c., qt. 75c.
- Golden Cluster, Dreer's.** Pods a beautiful golden yellow, from 6 to 8 in. long, produced in clusters of four to six. The earliest of the pole wax Beans and very productive. Quality excellent. Pt. 50c., qt. 85c.
- Improved Kentucky Wonder (Old Homestead).** Excellent, very productive. Pods a silvery-green color of large size and entirely stringless. Pt. 40c., qt. 75c.
- Italian Pole (New).** A green-podded pole string Bean, slightly streaked with purple, absolutely stringless, unsurpassed for a string or shell Bean. Pt. 60c., qt. \$1.00.
- Kentucky Wonder Wax.** A Wax Pole Bean with all the good qualities of old Kentucky Wonder or Old Homestead. Pt. 50c., qt. 85c.
- King Horticultural (Worcester).** Early and productive. The long, beautifully colored pods hang in rich clusters. A greatly improved pole horticultural. Pt. 50c., qt. 90c.
- Lazy Wife.** Pods long, stringless and of a rich buttery flavor. Pt. 45c., qt. 85c.
- Lima, Carpinteria.** A large-seeded variety of vigorous growth. Pods large and well filled with beans of excellent flavor. Pt. 50c., qt. 90c.
- Lima, Dreer's Improved or Challenger.** An improved Lima, different in shape, being much thicker than the old Lima and superior in quality. Pt. 45c., qt. 85c.

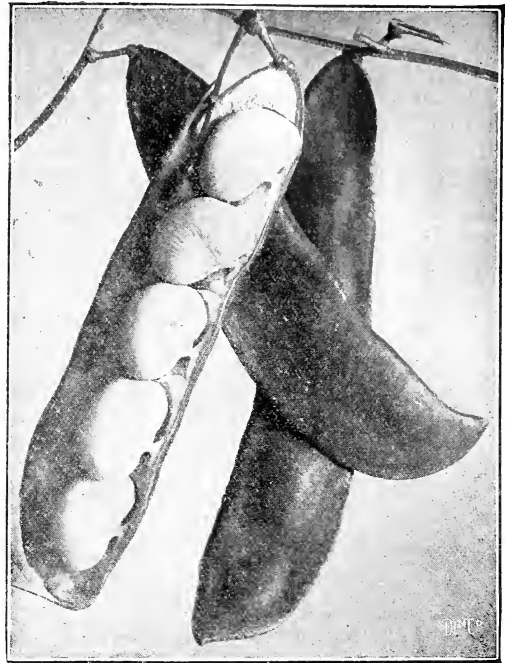

Dreer's Improved Lima

- Lima, Siebert Early.** An immense yielder and excellent quality. Pt. 45c., qt. 85c.
- Lima Sieva, or Small.** A popular small-seeded variety. Pt. 45c., qt. 85c.
- Mont d'Or, or Golden Butter.** A strong, vigorous grower, with pods 6 to 8 in. long in clusters, thick and fleshy. Pt. 50c., qt. 90c.
- Runner, Scarlet.** Bright scarlet flowers. Used both as a string and shelled Bean. Pt. 45c., qt. 80c.
- Runner, White.** Very effective planted with the Scarlet Runner. Pt. 45c., qt. 80c.

DWARF SHELL BEANS

- Improved Yellow Eye.** One of the best sorts for baking; extremely productive and of superior quality. Pt. 20c., qt. 35c., 4 qts. \$1.25.
- Vermont Pea Bean.** A most productive small white baking variety, of superior quality. Pt. 20c., qt. 35c., 4 qts. \$1.25.
- Red Kidney.** Popular baking bean. Pt. 20c., qt. 35c., 4 qts. \$1.25.

BROCCOLI

One ounce will produce 2000 plants

- This vegetable closely resembles the Cauliflower. A very rich, deep soil is required to grow the Broccoli to perfection, the seed should be sown early in the Spring and the plants transplanted into rows 3 feet apart, with 2 feet between the plants.
- Early Green Calabrese.** A distinct variety forming good sized green heads; this vegetable resembles the cauliflower with the combined cauliflower and asparagus flavor. Seed imported. Pkt. 25c., oz. \$1.50, ¼ lb. \$5.00.
- White Cape.** Heads compact, good size, and of a creamy white. Pkt. 25c., oz. \$1.75.

BEET

One ounce will sow 50 feet of drill; 5 to 6 lbs. an acre.

A deep, light, sandy loam that has been well enriched is best adapted to the growth of the Beet. Sow in drills from April until July 16 inches apart and about 1 inch deep; thin the plants to about 3 inches apart. The Turnip-rooted are the best, and all early varieties are used extensively for greens.

Bastian's Early. Of quick and large growth; bright red color. Pkt. 10c., oz. 25c., $\frac{1}{4}$ lb. 75c., lb. \$2.75.

Crimson Globe. Early, of globe shape, and rich, deep crimson flesh. Pkt. 10c., oz. 30c., $\frac{1}{4}$ lb. \$1.00, lb. \$3.00.

Crosby's Egyptian, Selected, Arlington Grown. One of the earliest dark-leaved varieties; fine quality. Pkt. 15c., oz. 75c., $\frac{1}{4}$ lb. \$2.50, lb. \$8.00.

Crosby's Egyptian. One of the earliest dark red varieties. fine quality. Very popular among market gardeners. Pkt. 10c., oz. 25c., $\frac{1}{4}$ lb. 75c., lb. \$2.00.

Detroit Dark Red. Round and smooth, deep red, very tender. Pkt. 10c., oz. 25c., $\frac{1}{4}$ lb. 75c., lb. \$2.00.

Dewing's Blood Turnip. Of fine form and flavor; deep red. A desirable variety. Pkt. 10c., oz. 15c., $\frac{1}{4}$ lb. 55c., lb. \$1.75.

Early Eclipse. Early, globe-shaped, dark red, small top, smooth roots. Pkt. 10c., oz. 25c., $\frac{1}{4}$ lb. 75c., lb. \$2.50.

Early Wonder. The most perfect model of an extra early round Beet. The flesh is deep blood-red crimson. It is an ideal all season Beet, for while it grows a nice size Beet early, it retains its tender quality throughout the season. Pkt. 10c., oz. 30c., $\frac{1}{4}$ lb. \$1.00.

Edmand's. Deep blood-red color, round and smooth, excellent quality; highly recommended. Pkt. 10c., oz. 20c., $\frac{1}{4}$ lb. 60c., lb. \$2.00.

Grey's Blood Turnip. One of the very best strains for market gardeners; small top, round, handsome and very dark red. Pkt. 10c., oz. 25c., $\frac{1}{4}$ lb. 75c., lb. \$2.50.

Perpetual, or Spinach Beet. Producing green leaves in abundance close to the ground. This variety will give a constant supply of spinach throughout the season. Pkt. 10c., oz. 25c., $\frac{1}{4}$ lb. 85c.

Swiss Chard. The leaves are used as Spinach, and the midrib of the leaf, cooked and served up like asparagus, is delicious. Pkt. 10c., oz. 25c., $\frac{1}{4}$ lb. 85c.

Swiss Chard, Lucullus. A tall-growing variety, crinkled leaves, tender and of fine flavor. Pkt. 10c., oz. 25c., $\frac{1}{4}$ lb. 85c.

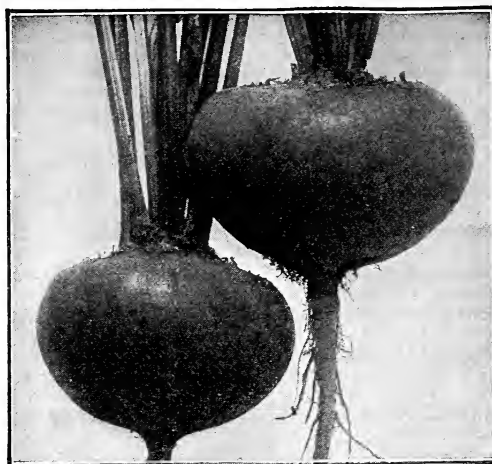

Early Wonder

SUGAR BEET and MANGEL WURZEL

Sow in April or May, using 6 to 10 lbs. of seed to the acre.

Grey's Prize Long Mangel Wurzel. The most largely grown of any of the Mangels; roots attain an enormous size, producing 30 to 50 tons to the acre; quality superior, the best for deep soil. Oz. 15c., $\frac{1}{4}$ lb. 40c., lb. \$1.25.

Golden Tankard Mangel Wurzel. The flesh is bright golden yellow; very large, and will produce more Mangels to the acre than any other variety; excellent for feeding stock. Oz. 10c., $\frac{1}{4}$ lb. 30c., lb. 75c.

Giant Yellow Intermediate Mangel Wurzel. A very large yellow sort, of good quality, and produced in great abundance. Oz. 10c., $\frac{1}{4}$ lb. 30c., lb. 75c.

Lane's Improved Sugar Beet. Large, hardy, productive and excellent quality. Oz. 10c., $\frac{1}{4}$ lb. 30c., lb. \$1.00.

Norbition Giant Mangel Wurzel. Long red. A valuable variety for deep soil; very productive. Oz. 10c., $\frac{1}{4}$ lb. 30c., lb. 75c.

Red Globe. Similar to Yellow Globe except in color. Oz. 10c., $\frac{1}{4}$ lb. 30c., lb. 85c.

Yellow Globe Mangel Wurzel. A large, round, orange-colored variety of excellent quality; good keeper; best for shallow soil. Oz. 10c., $\frac{1}{4}$ lb. 30c., lb. 80c.

BRUSSELS SPROUTS

One ounce will produce 2000 plants

Cultivated for the small heads that grow from the main stem; these small heads are firm and compact, like little Cabbages, and are considered a great delicacy by many people. Cultivate the same as Cabbage or Cauliflower.

Aigburth. Very large sprouts; hardy and productive. Pkt. 10c., oz. 50c., $\frac{1}{4}$ lb. \$1.50.

Dobbie's Exhibition. Grows taller than the above; is of good quality and very productive. Pkt. 25c., oz. \$1.25.

Improved Dwarf French. Tender and of fine flavor. Pkt. 15c., oz. 75c.

Long Island Improved. Very compact heads; productive. Pkt. 25c., oz. \$1.25.



Brussels Sprouts, Dobbie's Exhibition

CABBAGE

One ounce produces about 3000 plants.

For early use a sowing may be made in the hotbed in February or March, and for Winter use seed should be sown in the open ground in May or June. When the plants are 5 or 6 inches in height, transplant into rows 3 to 3½ feet apart, setting the plants from 2 to 3 feet apart in the rows, according to the variety. A deep, rich, loamy soil is best adapted to the growth of this crop, and if large, fine heads are expected, the land must be prepared by very heavy manuring. A handful of wood ashes thrown into the forming heads will not only keep off the cabbage-fly, but will assist the growth of the plants to a considerable extent. Slug Shot is equally effective.

All-Seasons. An early drumhead, sure heading, solid variety. Desirable for early or Fall use. Pkt. 10c., oz. 30c., ¼ lb. \$1.25.

All-Head. Earliest of the large Cabbages; heads uniformly solid. Pkt. 10c., oz. 50c., ¼ lb. \$1.75.

American Improved Savoy. The favorite curled Savoy Cabbage of finest quality, and an excellent keeper. Pkt. 10c., oz. 40c., ¼ lb. \$1.50.

Autumn King. The heads are of enormous size and very solid. Pkt. 15c., oz. 50c., ¼ lb. \$1.50.

Baby Head Cabbage. Introduced by one of the best Cabbage growers in Denmark. This is an extra early round, hard headed Cabbage, 10 days earlier than any other round headed variety. The heads are small and of fine quality. We recommend Baby Head Cabbage for greenhouse growing and where space is limited. The seed we offer is grown for us in Denmark. Pkt. 15c., oz. \$1.00, ¼ lb. \$3.00.

Charleston, or Large Wakefield. This strain is about one week later than early Jersey Wakefield. Pkt. 15c., oz. 75c., ¼ lb. \$2.75.

Chinese Wong Bok. This is the famous Chinese Celery Cabbage. It has wide midribs at the base and merges into crisp, tender leaves at the top, the whole being very compact and heavy. It blanches to almost clear white. The culture for Wong Bok is the same as for late Cabbage. Well grown plants should be blanched by tying loosely with burlap. Pkt. 10c., oz. 60c., ¼ lb. \$2.00.

Copenhagen Market. As early as Charleston Wakefield. Very solid. Excellent market sort. Pkt. 10c., oz. 40c., ¼ lb. \$1.50.

Danish Ball Head. A Winter Cabbage. Extra hard-headed of fine quality. Pkt. 15c., oz. 40c., ¼ lb. \$1.50.

Danish Round Head. A short-stemmed type of the Danish Ball Head, maturing earlier than that variety; excellent quality, large, solid, globe-shaped heads. One of the best Winter sorts. Pkt. 10c., oz. 60c., ¼ lb. \$2.25.

Earliest of All. Similar to Copenhagen Market, but much earlier. A Danish introduction. Pkt. 25c., oz. \$1.00.

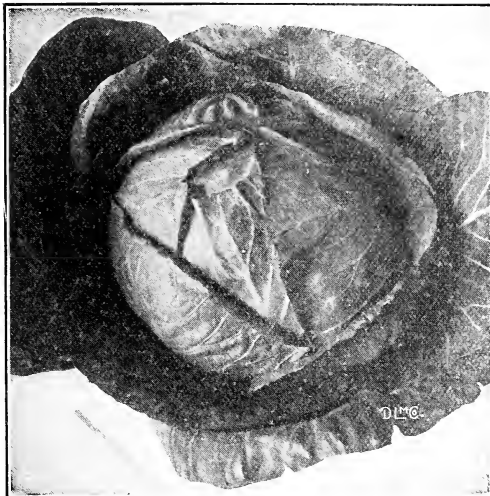

Copenhagen Market

Early Summer, Henderson's. A few days later than Wakefield, rather larger and more globe-shaped. Pkt. 10c., oz. 40c., ¼ lb. \$1.50.

Early Jersey Wakefield. One of the most popular, early pointed varieties; good grower. Pkt. 10c., oz. 35c., ¼ lb. \$1.25.

Early Wonder Red. The earliest of all red Cabbages. The heads are large, solid and handsome, of delicious flavor, color dark red. July. Pkt. 25c., oz. \$1.00.

Early Winnigstadt. Pointed variety; both for early and late sowing. Pkt. 10c., oz. 35c., ¼ lb. \$1.25.

Fotter's Brunswick. The standard market variety; a drumhead; grows to a large size; solid, tender, good shape and a good keeper. Pkt. 10c., oz. 40c., ¼ lb. \$1.25.

Globe Curled Savoy. A variety with finely curled leaves and of delicate flavor; used for Fall crop or for Winter. Pkt. 25c., oz. \$1.00, ¼ lb. \$3.75.

Golden Acre. A new Cabbage, head measuring 9 in. in diameter; 10 days earlier than Copenhagen Market and more compact. Pkt. 25c., oz. \$1.50.

Mammoth Red Rock. The largest and surest heading Red Cabbage; heads as large and solid as Flat Dutch and fine grained. Pkt. 10c., oz. 50c., ¼ lb. \$1.75.

Marblehead Mammoth. The largest known variety, drumhead; sometimes growing to weigh over 50 pounds; reliable header. Pkt. 15c., oz. 75c., ¼ lb. \$2.75.

Penn State Ball Head. A large somewhat flattened form of the ball head, producing probably the largest tonnage per acre of any known variety. This is one of the best winter varieties. Pkt. 15c., oz. \$1.00, ¼ lb. \$3.50.

Red Dutch Pickling. Used extensively for pickling; tender, medium size. Pkt. 10c., oz. 50c., ¼ lb. \$1.75.

Stone Mason. Select strain. One of the oldest and best-known varieties; large size; drumhead; grown principally as a late Cabbage, and for winter keeping. Pkt. 20c., oz. \$1.00, ¼ lb. \$4.00.

Cabbage Plants. See page 24.

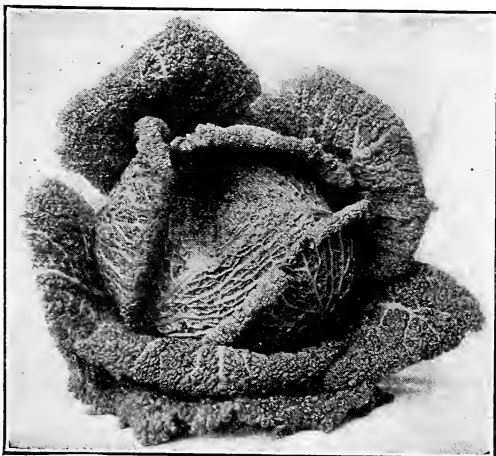

Globe Curled Savoy, Special Strain



Carrots, Danvers Half-long Improved, Special Strain

CARROT

One ounce will sow 100 feet of drill, 3 lbs. required for one acre.

The Carrot flourishes best in a good, light, well enriched loam. Where there is a choice of situations, heavy and wet soils should be avoided, and preference given to the light and dry. For an early crop sow as soon as the ground is in good working condition; planting for general crop may be made as late as June, but early sowings succeed best. The early, small-sized varieties may be sown in drills 10 inches apart, but the larger sorts require at least 18 inches between the rows; cover about $\frac{1}{2}$ inch deep, and when the plants are well up, thin to 3 to 4 inches apart. As an agricultural root, the Carrot is unsurpassed for feeding stock.

We furnish packets of all varieties of Carrots at 10c. each, postpaid, except where noted.

Chantenay Half-long, Stump-rooted. The best sort for bunching, stump-rooted and a good color at all stages of growth. Oz. 35c., $\frac{1}{4}$ lb. \$1.00.

Danvers Half-long. The best variety for general crop; is of rich color and a good keeper; yields largely and is easily harvested. Oz. 30c., $\frac{1}{4}$ lb. \$1.00, lb. \$3.00.

Danvers Half-long Improved, Special Strain. Grown for us by a leading market gardener in Danvers. Pkt. 15c., oz. 75c., $\frac{1}{4}$ lb. \$2.75.

Earliest French Forcing. A small round root; the earliest variety and good for forcing under glass. Pkt. 15c., oz. 50c., $\frac{1}{4}$ lb. \$1.50.

Early Scarlet Horn. A medium-sized root, half-long, of fine color, and much used for cooking; grown for early use and to sell in bunches. Oz. 25c., $\frac{1}{4}$ lb. 75c., lb. \$2.50.

Guerande or Oxheart. Intermediate length, 3 to 5 in. in diameter; fine quality. Oz. 25c., $\frac{1}{4}$ lb. 75c., lb. \$2.50.

Hutchinson Strain. A very fine Carrot, 8 to 9 in. long, nearly the same size the whole length and stump-rooted. Color deep orange and of fine quality. Pkt. 15c., oz. 75c., $\frac{1}{4}$ lb. \$2.75.

Half-long Scarlet Nantes. A stump-rooted variety of fine color. Oz. 30c., $\frac{1}{4}$ lb. 75c., lb. \$2.50.

Improved Long Orange. Excellent for stock or table use; roots deep orange. 12 to 15 in. Oz. 20c., $\frac{1}{4}$ lb. 65c., lb. \$2.00.

Improved Short White. The largest and heaviest cropping Carrot known; the roots are short, very heavy at the shoulder, of uniform shape and smooth. Oz. 20c., $\frac{1}{4}$ lb. 65c., lb. \$2.00.

James' Intermediate. The best intermediate variety, tapering to a point; small core and of fine flavor. Oz. 30c., $\frac{1}{4}$ lb. \$1.00, lb. \$3.00.

Pride of Denmark. A wonderful fine Carrot, 8 to 9 in long and 2 to 3 in. in diameter, being practically the same size the whole length. It closely resembles the Hutchinson, but has less core and deeper color. Pkt. 15c., oz. 75c., $\frac{1}{4}$ lb. \$2.75.

North Scituate, Mass., October 11, 1928

Thomas J. Grey Company
16 South Market Street, Boston, Mass.

Gentlemen: As usual, I have had splendid crops from your seeds this year. Please book my order for Snowball Cauliflower seed for 1929 Spring delivery. Today, I have forwarded you three heads of Snowball Cauliflower for your inspection. Note the fine white heads, and splendid quality.

Yours very truly,
Prescott A. Damon.

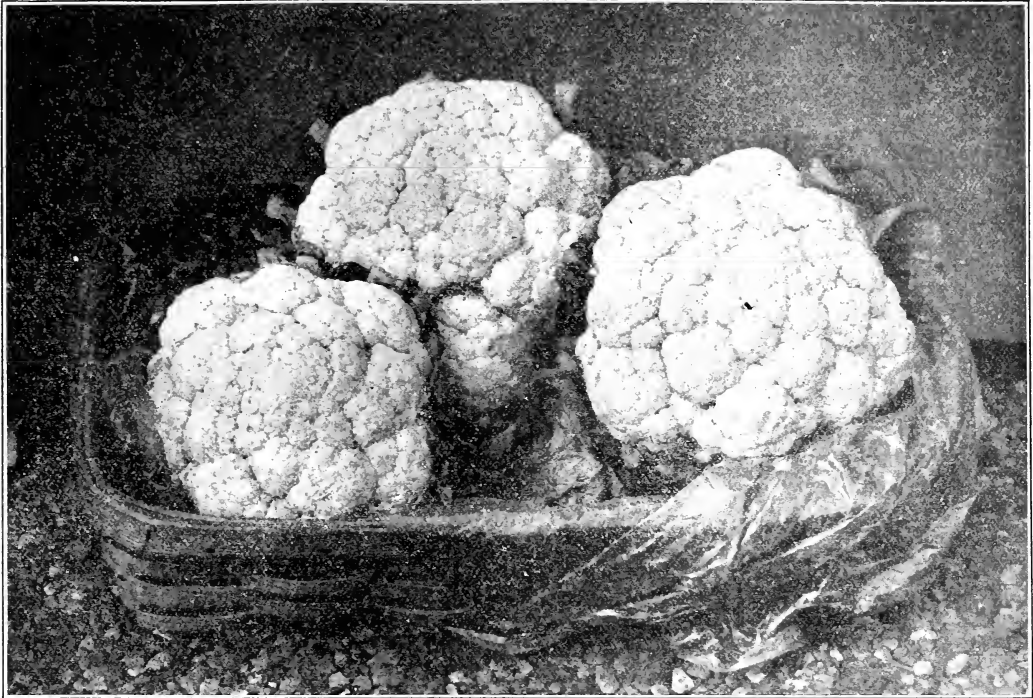

Cauliflower, Early Snowball, Grown by Prescott A. Damon

CAULIFLOWER

One ounce will produce 3000 plants.

The Cauliflower, like the Cabbage, requires a deep, rich soil and seldom succeeds well when grown on land long under cultivation. Sow the seed in the hotbed in March and transplant into the garden in May; set the plants in rows and cultivate the same as Cabbage. If the season is dry, water often, as Cauliflowers cannot be grown to perfection without plenty of moisture.

Danish Perfection. A very early variety of the Dwarf Erfurt type. The leaves are long, stand straight up, making the inner leaves curl over and protect the head. All the heads mature the same time, making it possible to clear the ground at one cutting. Pkt. 25c., oz. \$5.00.

Early Snowball. Grey's Selected. A favorite variety very sure to head. This strain has given excellent satisfaction during the many years we have sold it, and we believe no better strain can be found. Pkt. 25c., oz. \$5.00, $\frac{1}{4}$ lb. \$16.00.

Earliest Dwarf Erfurt. One of the earliest varieties; very dwarf, with large, white, compact heads of finest quality. Excellent for forcing. Pkt. 25c., oz. \$5.00, $\frac{1}{4}$ lb. \$16.00.

Early Dwarf Danish, or Dry Weather. A choice strain that comes to maturity very evenly; a favorite for first crop with many growers. Pkt. 25c., oz. \$4.00, $\frac{1}{4}$ lb. \$15.00.

Lenormand's Short-Stem. A large, late short-stemmed variety. Pkt. 10c., oz. \$1.50, $\frac{1}{4}$ lb. \$5.00.

Veitch's Autumn Giant. Heads very large, white and compact; well protected by foliage; will remain suitable for use a long time. Pkt. 15c., oz. \$1.00, $\frac{1}{4}$ lb. \$3.00.

CHERVIL

Curled Chervil. Cultivated like Parsley. The young leaves for flavoring soups and salads and are also used for garnishing. Pkt. 10c., oz. 40c., $\frac{1}{4}$ lb. \$1.50.

CHICORY See Endive, page 11.

Large-rooted Magdeburg. Roots when dried and roasted are used as a substitute for coffee. Pkt. 10c., oz. 35c., $\frac{1}{4}$ lb. 75c.

Witloof, or French Endive. Plant in May or June in drills. Thin to 6 inches apart. Early in the Fall the roots should be removed, the tops cut off to within $1\frac{1}{2}$ inches of the neck; the roots make a uniform length of 8 or 10 inches. They should then be planted in trenches somewhat below the level of the ground. Trenches should be filled with light soil, or if a quick growth is desired, should be covered with horse manure several inches deep. In about four weeks the leaves will be ready for use. Pkt. 10c., oz. 50c., $\frac{1}{4}$ lb. \$1.50.

Chives. In frequent demand for soups and salads. Pkt. 25c. Plants 30c. per clump.

CELERY

One ounce will produce about 4000 plants.

Sow the seeds in March or April in a hotbed or cold-frame. As soon as the plants are 3 inches high, transplant into a prepared border, setting them 4 inches apart. When grown 6 inches, and fine stocky plants, set in richly manured deep soil, in rows $3\frac{1}{2}$ feet apart and about 9 inches from plant to plant. Water if dry weather follows transplanting. During the next two months all the attention required is to keep down weeds. Afterward earth up a little and continue doing so at intervals until only the tops of the leaves are visible late in Autumn. Never hoe or earth up when the plants are wet.

Boston Market (Arlington grown). The finest flavored variety in cultivation; solid, crisp and of excellent nutty flavor; dwarf, branching habit; blanches perfectly white; a splendid keeper. Pkt. 25c., oz. \$2.00.

Carter's Dwarf Crimson. Crisp, tender and delicious; a good keeper. Pkt. 25c., oz. \$1.50.

Celeriac or **Turnip-rooted Celery, Giant Smooth Prague.** Turnip-shaped roots which may be cooked, sliced and used in vinegar, also in soup; cultivated as Celery. Pkt. 10c., oz. 50c., $\frac{1}{4}$ lb. \$1.50.

Easy Blanching. A comparatively new early variety, recommended for both the home and market garden. The plants make a rapid and vigorous growth, producing rather thick, solid stalks of excellent quality and rich, nutty flavor. Pkt. 25c., oz. \$2.00.

Giant Pascal (Arlington grown). Of a fine nutty flavor, entirely free from any bitter taste. It grows about 2 ft. high, the stalks being broad, thick, solid and crisp, with golden yellow heart. A valuable variety for both second early and Winter use. Pkt. 25c., oz. \$2.00.

Golden Plume. An improved strain of Golden Self-blanching. The plants are of strong growth and produce thick and heavy stalks of excellent crisp and nutty

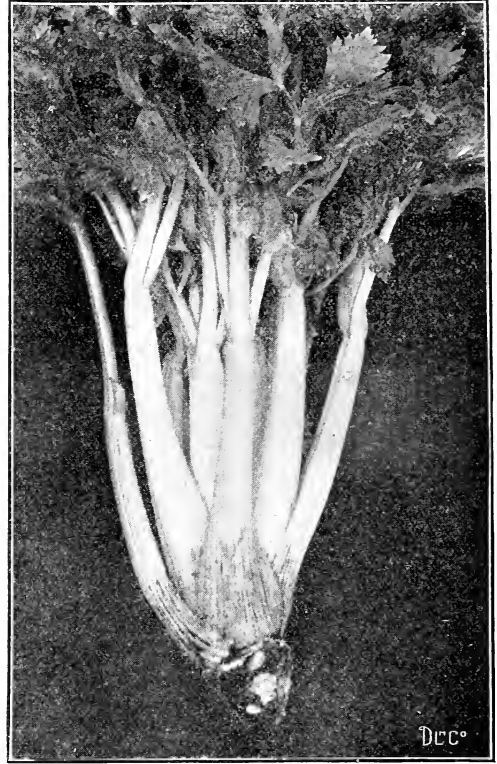

Giant Pascal

flavor. It is considered by many gardeners the best of all early varieties. Pkt. 25c., oz. \$1.50, $\frac{1}{4}$ lb. \$5.00.

Newark Market. A green, easy blanching variety, the stalks are large and heavy, broad, solid, crisp and tender; a good keeper and will blanch in cold storage. Pkt. 25c., oz. \$2.50.

Paris Golden. Without doubt the finest early Celery in cultivation. The plant blanches quickly to a beautiful golden yellow; the stalks are brittle and have a fine nutty flavor. This is one of the best Celerys for the home garden and market. Pkt. 25c., oz. \$1.50.

White Plume. Very ornamental; the stalks and portions of the leaves are naturally white. Pkt. 10c., oz. 75c., $\frac{1}{4}$ lb. \$2.25.

Winter Queen. This is one of the finest dwarf Winter Celerys. The plants make large bunches of extra heavy stalks with very large heart which, when blanching, are of a creamy white color. Pkt. 15c., oz. 60c.

CRESS, or PEPPER GRASS

One ounce will sow 100 feet of drill.

A popular salad, which should be sown early in Spring—very thickly in shallow drills—and at short intervals, for succession, as it soon runs to seed.

Extra Curled. The best variety grown; leaves are beautifully cut and curled; highly prized for garnishing. Pkt. 10c., oz. 20c., $\frac{1}{4}$ lb. 50c., lb. \$1.50.

Water. This wholesome salad may be grown in any moist situation, but more successfully by the edge of a running brook. The seed may be sown in May on the ground where it is intended to be grown and the thinnings transplanted. The plants should be set not less than a foot apart. The Cress will be fit for gathering the second year. Pkt. 10c., oz. 75c.

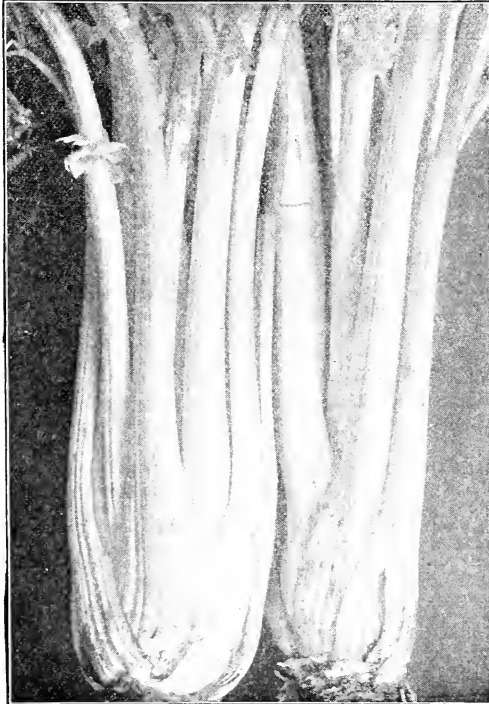

Golden Self-blanching

CORN, Sweet, or Sugar

One quart will plant 200 hills; ten quarts will plant one acre in hills.

We furnish 15c. packets of all varieties of Sweet Corn free of postage by mail. For other quantities add Parcel Post rate if to go by mail. One quart weighs about 2 pounds.

Corn requires a mellow, loamy, well pulverized soil, and frequent hoeings. Plant in hills 3 feet apart each way, dropping five or six kernels in each hill, or plant in rows 3 to 4 feet apart, and thin the plants out to 8 or 9 inches in the row. From the beginning of May until the middle of July successive plantings can be made every two or three weeks, and by properly selecting the varieties a continued supply can be had until frost kills the plants.

Bantam Evergreen Corn. A yellow variety maturing about 10 days after the Golden Bantam and a week earlier than the Stowell's Evergreen white. It has an ear three times the size of Golden Bantam. Pt. 30c., qt. 50c., pk. \$3.50.

Corn, Field and Fodder. See page 25.

Country Gentleman. Cob small, with deep kernels of pearly whiteness; quality delicious. Pt. 30c., qt. 50c., pk. \$2.50.

Early Crosby. A popular variety; early, good size and quick growth; white kernels and one of the best. Pt. 30c., qt. 50c., pk. \$3.00.

Early Dighton. The earliest of all the white sugar corn varieties. An ideal sort for first and last planting. Pt. 30c., qt. 50c.

Early Golden Improved. Sweet, tender and delicious. Ears large, ten- to twelve-rowed, rich golden yellow color. New England grown. Pt. 30c., qt. 50c., pk. \$3.50.

Early Surprise. An extra early variety maturing a week earlier than White Cory, very much in demand for its earliness and sweetness. Pt. 30c., qt. 50c.

Golden Bantam. Early, sweet and tender. Smaller than Early Golden; eight-rowed. A favorite variety. Pt. 30c., qt. 50c., pk. \$3.50.

Golden Giant. With its 12- to 16-rowed ears and deep golden yellow kernels is the most desirable yellow sweet Corn yet introduced. The stalks are short, sturdy and frequently produce two ears. Seed offered this year has been carefully grown in Massachusetts. Pt. 40c., qt. 75c.

Golden Sunshine. The earliest of the Golden Bantam type, maturing a week to ten days earlier than that variety; more dwarf in habit than Bantam, with ears 6½ inches long containing 12 rows of broad, yellow, sweet grains; especially desirable for its extreme earliness. Pt. 30c., qt. 50c., pk. \$3.50.

Mayflower, Early. An extra early white variety. Matures one week in advance of White Cory. Growth of stalk 4½ to 5 feet, eight to twelve rows of kernels; large ear. Pt. 25c., qt. 45c., pk. \$3.00.

Peep-O-Day. This Corn has two valuable points—extraordinary earliness and sweetness. It may be used as an early or late variety with equal success. Pt. 25c., qt. 40c., pk. \$2.50.

Pocahontas. One of the earliest varieties in cultivation; ears large and very productive; of fine quality. Pt. 25c., qt. 40c., pk. \$2.50.

Potter's Excelsior, or Squantum. Medium late; grows to a good height and produces medium-sized, twelve-rowed ears of excellent quality. The sweetest white Corn. Requires liberal seeding, the germ being delicate. Pt. 25c., qt. 40c., pk. \$2.50.

Stowell's Evergreen Special Strain. The Corn is an earlier type than the old variety, maturing a week earlier and especially adapted for New England. The kernels are long and narrow, 18- to 22-rowed. Pt. 35c., qt. 60c., pk. \$3.50.

Whipple's Yellow Sweet Corn. This is a wonderful early yellow Corn that has proved very profitable to raise for market. This Corn is earlier than Bantam and as large as Evergreen. The ears are very large, 8 to 9 in. long having 14 to 18 rows of deep kernels. Pt. 30c., qt. 50c., pk. \$3.50.

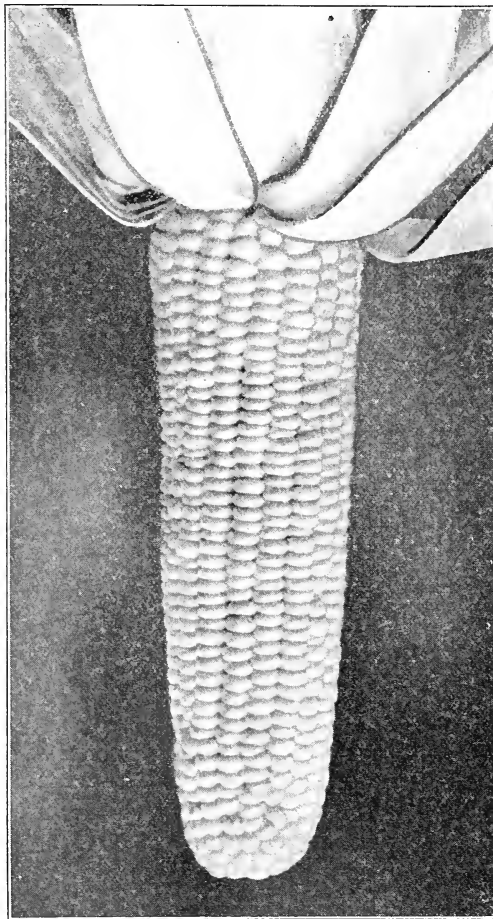

Stowell's Evergreen, Platt's Strain

CORN SALAD or FETTICUS

One ounce will sow 100 feet of drill.

This excellent salad may be had the year round. Sow in September, in drills 8 inches apart, covering the seeds lightly and protect from frost by a light covering of hay or litter. The seed may also be sown in Spring.

Large-Seeded. The most popular variety grown. Pkt 10c., oz. 30c., ¼ lb. \$1.00.

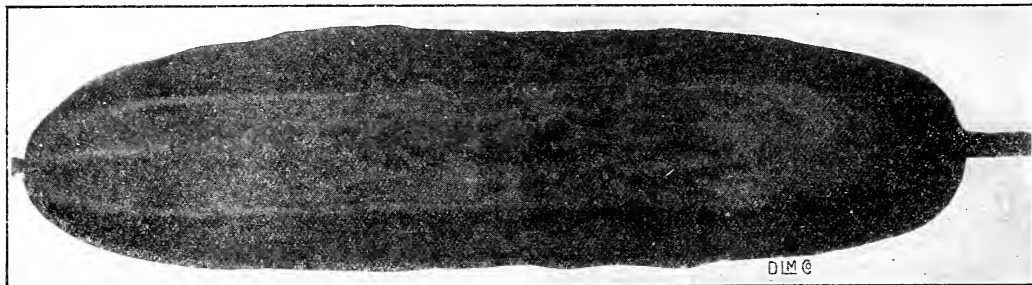

Arlington White Spine

CUCUMBER

One ounce will plant about 50 hills, 1½ lbs. to one acre.

For very early use seed may be started in heat and the plants set out in May. Pieces of inverted sod are an excellent medium for starting and growing early Cucumber plants, as they can be readily lifted from the hotbed to the garden without disturbing the young plants growing upon them. For main crop, plant in hills 4 feet apart, in the end of May. Make the hills rich with well rotted manure, and keep the young plants safe from the striped bug by dusting with dry plaster, or powdered Hellebore. Leave four strong plants to each hill.

Arlington White Spine. One of the finest Cucumbers for forcing and one of the most perfect in shape, size, color and quality, and is very brittle and crisp. Pkt. 15c., oz. 40c., ¼ lb. \$1.50.

Boston Pickling. The best pickling variety yet introduced; very productive; quick growing, superior color and quality; the most popular variety among the market gardeners. Pkt. 10c., oz. 25c., ¼ lb. 75c.

Cool and Crisp. Extra early and very prolific; long, straight, slender and dark green. Pkt. 10c., oz. 20c., ¼ lb. 60c.

Davis Perfect. Highly recommended; dark, rich, green in color, crisp and tender. Pkt. 10c., oz. 30c., ¼ lb. \$1.00.

Early Russian. Earliest variety known; fruit small, about 5 in. long; quality fine. Pkt. 10c., oz. 25c., ¼ lb. 75c.

Early Frame, or Short Green. Medium size, very early and good for pickling and slicing. Pkt. 10c., oz. 20c., ¼ lb. 60c.

Early Cluster. Fruit small and borne in pairs; light green, great bearer; a standard sort. Pkt. 10c., oz. 20c., ¼ lb. 60c.

Forcing (Private Stock). Longer than our Arlington White Spine, and very uniform in shape and color. Especially recommended for forcing. Pkt. 50c., oz. \$5.50.

Grey's A-1. This variety, unlike most other sorts, succeeds equally well in the garden or in the greenhouse; the vines are exceptionally healthy and productive. The fruits will average 12 to 14 inches in length by 2½ inches in diameter and are very symmetrical; the color a very dark green. Pkt. 50c., oz. \$3.50.

Improved White Spine. The best variety for table use or for market; retains its color a long time after being picked; very productive. Pkt. 10c., oz. 20c., ¼ lb. 60c.

Japanese Climbing. Fruit about 10 in. long; thick and of fine flavor. Skin dark green, flesh pure white; can be grown on trellises and fences. Pkt. 10c., oz. 25c., ¼ lb. 75c.

Long Green. Prickly; firm, crisp, dark green; excellent table variety. Pkt. 10c., oz. 25c., ¼ lb. 75c.

West India Gherkin. Used for pickling purposes; a small, oval-shape variety; has the appearance of a bur. Pkt. 10c., oz. 25c., ¼ lb. 90c.

English Frame Varieties

The following are excellent varieties for growing in forcing houses:

Duke of Edinburgh, Rollinson's Telegraph, The Rochford, Epicurean, Tender and True. Each, per pkt. 50c.

DANDELION

One ounce will sow 200 feet of drill; 2 lbs. will sow an acre

Extensively used as early Spring greens, and considered very healthful. Sow seed in May or June, in any good soil, in drills 15 inches apart, upon beds made smooth with the rake. Cover very lightly and press the earth firmly upon the seed. Cultivate during the Summer to keep down the weeds. Cover with litter upon the approach of severe weather, and remove the covering early in Spring. If spare frames are at hand, they may be used to advantage by setting them over a portion of the bed, and forcing the Dandelions under them, thus forwarding a portion of the crop. Dandelions make an excellent salad if blanched by earthing up, or placing boards to exclude the light.

American Improved. A stocky, thick-leaf hardy variety, grown largely for the Boston market; the best for general use. Pkt. 25c., oz. \$1.50, ¼ lb. \$5.00.

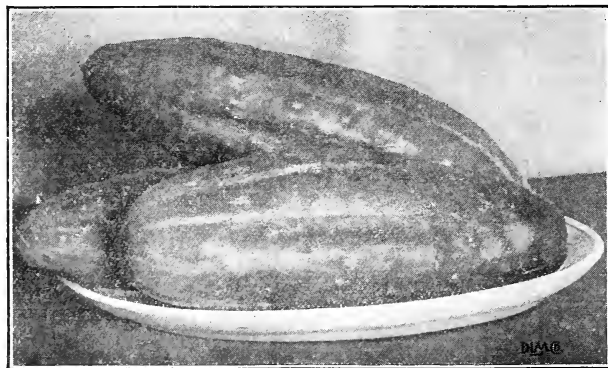

Cool and Crisp

EGGPLANT

One ounce will produce 1000 plants.

Sow in hotbeds very early in Spring, and transplant when 2 inches high into a second bed or into small pots. If that is not done, thin to 4 inches apart. Do not plant out till the weather becomes perfectly settled and warm. Cool nights or wet weather will check them. Keep some back in frames for a second planting, in case of weather changing unexpectedly. Keep plants watered for a few days if the sun is hot when put out. Set out plants 3 feet by 2.

Black Beauty. Very early and as large as New York Improved. Rich purplish black color. Pkt. 15c., oz. \$1.00.

Black Pekin. Fruit globular, almost black in color, fine grained, and delicately flavored. Pkt. 10c., oz. 75c.

Early Long Purple. A very early, hardy and productive variety of good quality. Pkt 15c., oz 85c.

New York Improved. A leading market variety; fruit large, oval, very productive. Pkt. 15c., oz. 85c.

ENDIVE

One ounce will sow 150 feet of drill.

A rather moist soil is preferred. Sow early in the Spring in drills 12 inches apart, and thin out the plants to 10 inches apart in the drills as soon as they are large enough to handle. Before using, the plants must be blanched, which is accomplished by gathering the leaves to a point at the top and tying them together with matting or any soft material. It makes a most delicious salad.

Broad-leaved Batavian. Leaves broad; light green, and require to be tied up for blanching. Pkt. 10c., oz. 35c., ¼ lb. \$1.00.

Green Curled. A very hardy, dark green, closely curled variety, tender and crisp. Pkt. 10c., oz. 35c., ¼ lb. \$1.00.

Moss Curled. Beautifully curled, and when well developed resembles a tuft of moss. Pkt. 10c., oz. 35c., ¼ lb. \$1.00.

Witloof. See Chicory, page 7.

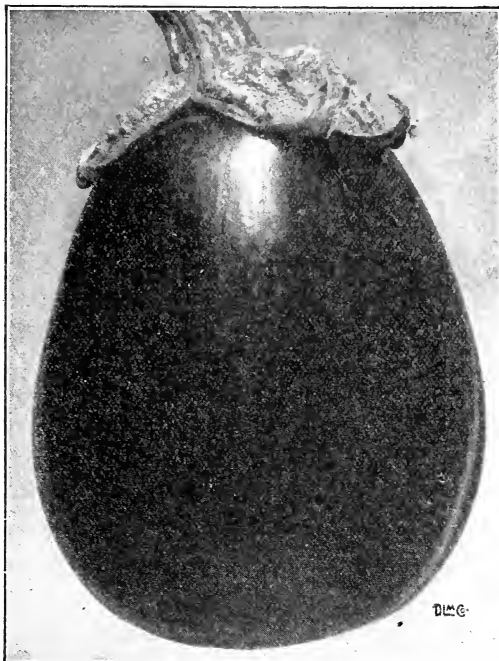
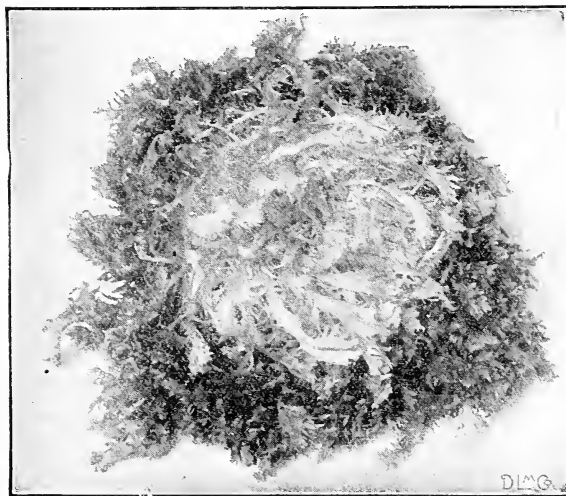

FENNEL, Florence, or Naples

(Finocchio di Napoli)

Sow in Spring in rows 16 to 20 inches apart and thin to 5 or 6 inches apart. Water freely. Pkt. 15c., oz. 50c.,

KALE, or BORECOLE

One ounce will produce 1500 plants.

Of all the Cabbage tribe this is the most tender and delicate. Early plants may be started in the hotbed, or the seeds may be sown in the open ground in April or May; transplant in June, into rows, and cultivate the same as Cabbage. Sea Kale should be blanched either under large pots or by banking up with sand.

Dwarf Green Curled. One of the best; very hardy and improved by a moderate frost. Pkt. 10c., oz. 30c., ¼ lb. \$1.00.

Sea Kale. Pkt. 20c., oz. \$1.00.

Winter, or Siberian Greens (Sprouts). Sow in August or early in September in rows 1 foot apart and cultivate like Spinach. A hardy variety. Pkt. 10c., oz. 25c., ¼ lb. 75c.

KOHL-RABI

One ounce will sow 200 feet of drill.

This vegetable, the popularity of which is rapidly increasing, combines the virtues of the Turnip and Cabbage, but excels both in nutritive, hardy and productive qualities. The seed may be sown in June in rows 18 inches apart, and the plants thinned out to 8 or 10 inches.

Purple Vienna. Similar to the following, except in color. Pkt. 10c., oz. 50c., ¼ lb. \$1.50.

White Vienna. The earliest and best table or market variety. Pkt. 10c., oz. 60c., ¼ lb. \$2.00.



Lettuce, Improved Big Boston

LETTUCE

One ounce will produce about 3000 plants

Lettuce succeeds best in rich and comparatively moist soil and is most crisp and tender if grown in cool, moist weather. The more rapidly the plants are grown, the more tender and brittle will be their quality. For early use, sow under glass in February or March, and transplant into a previously prepared hotbed; rows at least 12 inches apart, according to the varieties. Sowing may be made in the open ground as soon as all danger from frost is over; if a continuous supply is desired during season, make sowing every two or three weeks until September.

All the Year Round. A valuable variety, with compact, close heads. Pkt. 10c., oz. 40c., $\frac{1}{4}$ lb. \$1.00.

Big Boston. A most desirable variety either for forcing or open ground planting. Pkt. 10c., oz. 60c., $\frac{1}{4}$ lb. \$2.00.

Boston Curled. A variety highly esteemed for earliness and beauty of form. Pkt. 10c., oz. 40c., $\frac{1}{4}$ lb. \$1.00.

Black Seeded Mammoth Butter. The largest and considered by many the best variety for the late crop. Produces enormous formed heads of the finest quality. Pkt. 10c., oz. 40c., $\frac{1}{4}$ lb. \$1.25.

Deacon. Splendid variety for standing Summer heat; large, solid heads, tender, crisp and sweet. Pkt. 10c., oz. 40c., $\frac{1}{4}$ lb. \$1.50.

French, Unrivaled. Suitable for growing at any season. A sure heading variety, forming large, compact heads, and slow to run to seed. Similar to Big Boston, being lighter green in color and not tinged with brown. Pkt. 10c., oz. 40c., $\frac{1}{4}$ lb. \$1.50.

Giant Crystal Head. Outside leaves curled, with red edges. Heads large and solid. Pkt. 10c., oz. 30c., $\frac{1}{4}$ lb. 75c.

Grand Rapids. Crisp and tender, fine for forcing or outdoor culture. Pkt. 10c., oz. 40c., $\frac{1}{4}$ lb. \$1.00.

Hanson Improved. A superior, curled heading variety of large size, sweet, tender and crisp. Pkt. 10c., oz. 40c., $\frac{1}{4}$ lb. \$1.25.

Hittinger's Belmont Forcing. A choice strain for forcing. Much larger than the White Seeded Tennis Ball and a little later. Quality excellent. Pkt. 25c., oz. \$1.25, $\frac{1}{4}$ lb. \$4.00.

Iceberg. A solid heading large variety of excellent quality. Pkt. 20c., oz. 60c., $\frac{1}{4}$ lb. \$2.00.

May King. Grows quickly and produces globe-shaped heads which are ten to fourteen days earlier than any other, and which stand a long time before going to seed. Pkt. 10c., oz. 60c., $\frac{1}{4}$ lb. \$2.00.

May King, Selected Strain. As a Lettuce for greenhouse forcing, this is the best; heads form very quickly, are firm and of fine quality. Pkt. 25c., oz. \$1.00, $\frac{1}{4}$ lb. \$3.50.

Mignonette. Very solid and compact and of a distinct russet color. Pkt. 10c., oz. 60c., $\frac{1}{4}$ lb. \$2.00.

Prize Head. Large, loose heads, tinged with brown. Pkt. 10c., oz. 40c., $\frac{1}{4}$ lb. \$1.25.

Salamander. Fine compact heads, which resist Summer heat admirably. Pkt. 10c., oz. 50c., $\frac{1}{4}$ lb. \$1.60.

Simpson Black Seeded. Leaves delicate golden yellow; a superior variety either for forcing or sowing out of doors. Pkt. 10c., oz. 40c., $\frac{1}{4}$ lb. \$1.25.

Simpson Early Curled. Early variety; good for forcing or open ground. Pkt. 10c., oz. 25c., $\frac{1}{4}$ lb. 75c.

Sutton's Supreme. A fine Lettuce of the Drumhead type, and a marked advance on other varieties of the same class. Attains a large size, with a firm heart, which remains good for a long time before starting seed stems. Leaves prettily edged with red. Pkt. 25c.

Tennis Ball, Black Seeded, Select Strain. A very popular sort for open ground culture; forms a handsome head and is crisp and tender. Pkt. 15c., oz. 75c., $\frac{1}{4}$ lb. \$2.50.

Tennis Ball, White Seeded. Extensively grown for forcing and heading under glass; heads firm and good size, very white and crisp. Pkt. 10c., oz. 60c., $\frac{1}{4}$ lb. \$2.00.

Tom Thumb. A splendid variety for hotbeds and pot culture; compact heads and crisp. Pkt. 10c., oz. 60c., $\frac{1}{4}$ lb. \$2.00.

"Wayahead." Very early, with large, tightly folded heads; the outer leaves are light green, with the inner head finely blanched to a rich buttery yellow. Pkt. 10c., oz. 65c., $\frac{1}{4}$ lb. \$2.00.

Wonderful, or New York Cabbage. One of the largest varieties. Wonderful heat resister; strong grower. Heads solid, crisp and tender. Pkt. 10c., oz. 50c., $\frac{1}{4}$ lb. \$1.75.

Romaine, or Cos Varieties

Golden Yellow Cos. Large, solid heads with bright yellow leaves. Pkt. 10c., oz. 50c., $\frac{1}{4}$ lb. \$1.50.

Sutton's Little Gem Cos. An entirely distinct Cos. Lettuce, and a most valuable dwarf, compact variety. Dark green, small, solid, crisp, slow in running to seed, and of delicious quality. Pkt. 25c., $\frac{1}{2}$ oz. 60c., oz. \$1.00.

Trianon Self-Closing Cos. The finest of the Cos varieties. Leaves long, narrow and erect. Pkt. 10c., oz. 50c., $\frac{1}{4}$ lb. \$1.50.



Lettuce, Cos or Ron aine

LEEK

One ounce will sow 100 feet of drill.

The Leek is very hardy, and easily cultivated; it succeeds best in a light, but well enriched soil. Sow as early in Spring as practicable, in drills 1 inch deep and 1 foot apart. When 6 or 8 inches high, transplant in rows 10 inches apart each way, setting them deep, that the neck, being covered may be blanched.

Musselburgh, or Scotch. A very large variety of superior quality. Pkt. 10c., oz. 60c., $\frac{1}{4}$ lb. \$2.00.

Giant Carentan. Large size and extra fine quality. Pkt. 10c., oz. 50c., $\frac{1}{4}$ lb. \$1.25.

Large Flag Winter. Desirable for market or family use. Pkt. 10c., oz. 40c., $\frac{1}{4}$ lb. \$1.25.

Large Rouen. Grows to a large size and keeps well. Pkt. 10c., oz. 60c., $\frac{1}{4}$ lb. \$2.00.

MARTYNIA

One ounce will plant 100 hills.

Sow in the open ground in May, and thin out the plants to 2 or 3 feet apart, or a few seeds may be sown in a hotbed and afterward transplanted.

Froboscidea. Pkt. 10c., oz. 50c.

MUSKMELON

One ounce will plant 60 hills, two to three pounds for an acre.

Cultivate in hills, which should be 5 to 6 feet apart each way, and composed of light, moderately rich soil. The hills should be dug about 2 feet square, 18 inches deep, and half filled with well-rotted manure, which must be thoroughly incorporated with the soil. Plant in May, six to eight seeds to the hill, and when the plants are well up, thin out to three. Cultivate until the vines cover the ground, and pinch the ends of the growing shoots to induce early fruiting.

Green and Yellow-Fleshed Varieties

Arlington Nutmeg. Deep green, finely netted, flesh greenish yellow; rich and sugary. Pkt. 10c., oz. 25c., $\frac{1}{4}$ lb. 75c.

Bay View. Largest, most prolific, best flavored, finest Cantaloupe in cultivation. Pkt. 10c., oz. 15c., $\frac{1}{4}$ lb. 40c.

Extra Early Hackensack. Large size, round shape, deeply ribbed, roughly netted; flesh green, very sweet, and highly flavored. Pkt. 10c., oz. 15c., $\frac{1}{4}$ lb. 50c.

Honey Dew. A delicious new melon about 6 inches in diameter, weight about 5 to 6 pounds. One of the best and very sweet. Pkt. 15c., oz. 50c.

Long Yellow. Well-known standard variety; deeply ribbed; flesh yellow; thick and sweet. Pkt. 10c., oz. 25c., $\frac{1}{4}$ lb. 75c.

Miller's Cream. Nearly round, light green netted skin, with yellow flesh. Quality good. Pkt. 10c., oz. 25c., $\frac{1}{4}$ lb. 75c.

Montreal Nutmeg. A thick-fleshed Melon, delicious flavor, skin densely netted. Pkt. 10c., oz. 30c., $\frac{1}{4}$ lb. \$1.00.

Rocky Ford. One of the best varieties. Flesh thick and green; sweet and luscious. Pkt. 10c., oz. 30c., $\frac{1}{4}$ lb. \$1.00.

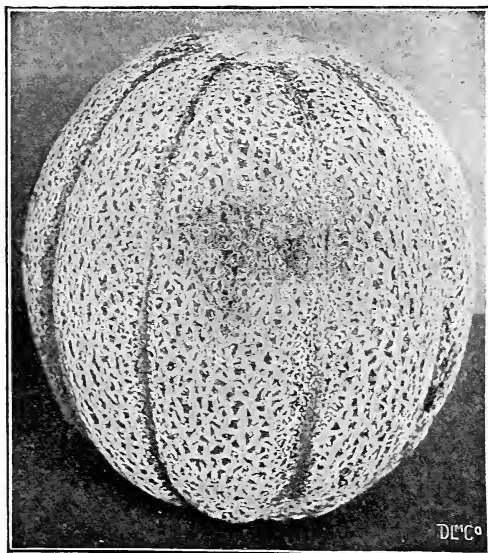
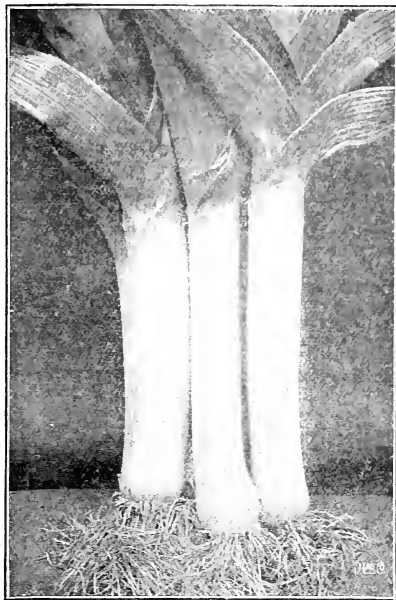

Rocky Ford Melon

Red, or Salmon-Fleshed Varieties

Burrell's Gem. Medium size. Flesh reddish orange, thick, fine grained and juicy. Pkt. 10c., oz. 15c., $\frac{1}{4}$ lb. 50c.

Early Christiana. One of the best first early sorts. Very short and deeply ribbed; flesh salmon colored, spicy and delicious. Pkt. 10c., oz. 50c., $\frac{1}{4}$ lb. \$1.25.

Emerald Gem. Small, extra early; smooth ribbed dark green skin and orange flesh; sweet. Pkt. 10c., oz. 30c., $\frac{1}{4}$ lb. \$1.00.

Honeydrop Improved. Flesh deep orange color, very thick and sweet with a delicious flavor; good size and very productive. Pkt. 15c., oz. 60c., $\frac{1}{4}$ lb. \$2.00.

Oka. A Montreal Melon originated by a Canadian horticulturist, is the result of several years selection of the Montreal Market crossed with a red-fleshed variety, sweet and juicy. The color is a beautiful cream, with a bright salmon flesh. Pkt. 25c.

English Frame Melons

Green Flesh Varieties: Sutton's Superb, Perfection, Best of All, Royal Favorite, Royal Sovereign, Royal Jubilee, Hero of Lockinge, Windsor Castle. Each 50c. per pkt.

Scarlet Flesh Varieties: Blenheim Orange, Sutton's Invincible, Triumph, Sutton's King George, Sutton's Superlative. Each 50c. per packet.

Cotting's Hybrid. A new greenhouse melon raised by Joseph Madden of Manchester, Mass. Flesh orange, oval-shaped, carries three to four melons to plant, weight five to six pounds each. Awarded two Certificates of Merit by the North Shore Horticultural Society and first class Certificate of Merit by the Massachusetts Horticultural Society. Pkt. 50c.

WATERMELON

One ounce will plant 30 hills. Four pounds will plant one acre.

Cultivate in the same manner as Muskmelons, but plant 8 to 10 feet apart.

Cole's Early. Very early variety; flesh very deep and sweet; color light green striped. Pkt. 10c., oz. 20c., $\frac{1}{4}$ lb. 50c.

Colorado Preserving. This is more productive than the common preserving Citron, and larger; the flesh is firm and solid. Pkt. 10c., oz. 20c., $\frac{1}{4}$ lb. 50c.

Cuban Queen. Beautifully striped, dark and light green; vigorous in growth; flesh bright red, solid, luscious, crisp and sugary. Pkt. 10c., oz. 20c., $\frac{1}{4}$ lb. 50c.

Early Fordhook. Extra early, good size, green skin, red flesh. Pkt. 10c., oz. 20c., $\frac{1}{4}$ lb. 50c.

Halbert Honey. Dark green skin; flesh crimson, luscious and sweet. Vigorous grower. Pkt. 10c., oz. 25c., $\frac{1}{4}$ lb. 50c.

Kleckley Sweets. Exceedingly sweet and fine flavored. Scarlet flesh. Pkt. 10c., oz. 25c., $\frac{1}{4}$ lb. 75c.

Ice Cream. Fruit round, of medium size; skin pale green; flesh scarlet, crisp and delicious. Pkt. 10c., oz. 20c., $\frac{1}{4}$ lb. 50c.

Mountain Sweet. One of the best for general culture; color dark green, rind thin, flesh scarlet, solid, very sweet and delicious. Pkt. 10c., oz. 20c., $\frac{1}{4}$ lb. 50c.

Phinney's Early. An early variety, of medium size; red fleshed, quite hardy, and very productive; quality excellent. Pkt. 10c., oz. 20c., $\frac{1}{4}$ lb. 50c.

Tom Watson. The flesh is rich red color. Solid sweet and luscious, and ripens close up to the rind. Pkt. 10c., oz. 25c., $\frac{1}{4}$ lb. 75c.

Vick's Early. Very early, oblong, medium size, with bright pink flesh, solid and sweet. Pkt. 10c., oz. 20c., $\frac{1}{4}$ lb. 50c.

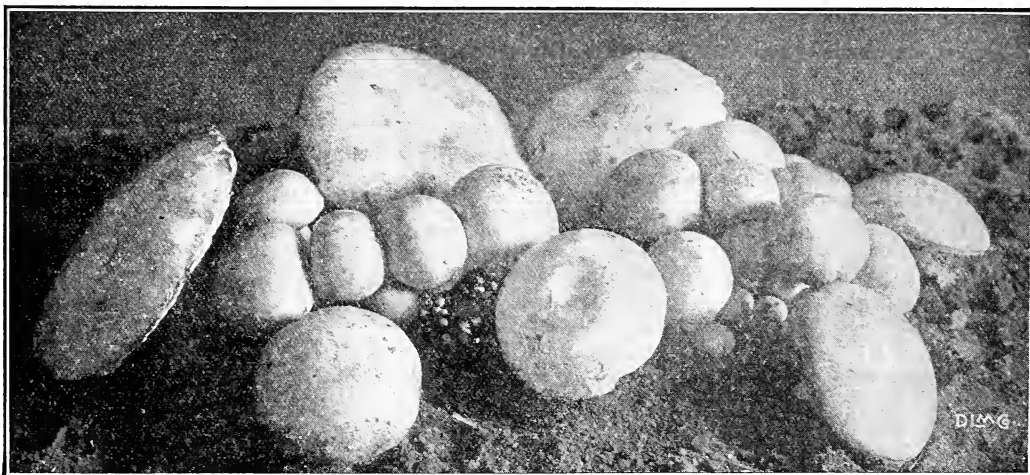

MUSHROOM

One pound of spawn is sufficient for nine square feet of bed.

Mushrooms are more easily cultivated than many people imagine, and may be grown in any dark room or cellar where the temperature can be maintained at from fifty to sixty-five degrees. For the bed, use a mixture of horse manure and good fresh loam in equal proportions. Before being placed in the bed let this material be thoroughly mixed, and well turned three or four times to sweeten in some dry place. Upon a dry, firm bottom, proceed to make the bed, by spreading a thin layer of the prepared mixture and pound it firm till the bed is eight inches thick. Leave it thus for about a week, or till the temperature of the bed has subsided to ninety or ninety-five degrees. Then make holes about 10 inches apart, and put in each a piece of spawn about the size of an egg. Cover the holes and press the soil solid and smooth. Let the bed remain in this condition ten days. Then cover with 2 inches of fresh loam. Over this place a few inches of straw. If the temperature is right, Mushrooms will appear in six to eight weeks from time of spawning. The bed will continue bearing about a month. After the first crop is gathered, spread over the bed an inch of fresh loam, and moisten with warm water. In the event of the surface of the bed getting very dry at any time, it should be moistened freely with water at a temperature of eighty to eighty-five degrees.

If wanted by mail, add postage at parcel post rates.

American Pure Culture. Single bricks 30c. each, 20 bricks \$5.00.

American Pure Culture. New mammoth strain. Single bricks, 40c. each, 20 bricks, \$7.00.

MUSTARD

One ounce will sow 50 feet of drill.

Green Mustard imparts a delightfully pungent flavor to the various forms of prepared salads. For early crops the seed may be sown in a hotbed in March, and for general crop at frequent intervals through the Spring, in drills from 8 to 12 inches apart.

Chinese Broad-leaved. Leaves much larger than the white Mustard. Flavor pleasantly sweet and pungent. Can be cooked like Spinach. Pkt. 10c., oz. 25c., $\frac{1}{4}$ lb. 75c., lb. \$2.00.

Fordhook Fancy. Very ornamental. Plants of vigorous growth; cooked same as Spinach. Pkt. 10c., oz. 25c., $\frac{1}{4}$ lb. 75c.

White. Much used for salads; the seed is also used medicinally, and as a seasoning for pickles. Pkt. 10c., oz. 20c., $\frac{1}{4}$ lb. 50c., lb. \$1.50.

OKRA, or GUMBO

One ounce will sow 40 feet of drill.

This plant is extensively cultivated for its green pods, which are used in soups and stews, and are very wholesome and nutritious. Sow about the middle of May, in drills 3 feet apart, and thin out the plants to 1 foot apart.

Improved Dwarf Green. Very early; smooth pods. Pkt. 10c., oz. 25c., $\frac{1}{4}$ lb. 50c.

White Velvet, or Creole. Pods smooth, of large size, and a creamy white. Pkt. 10c., oz. 25c., $\frac{1}{4}$ lb. 50c.

"HERBICIDE"

THE WEED EXTERMINATOR

ONION

One ounce will sow 100 feet of drill. Four or five pounds to the acre.

The Onion thrives best in light, loamy, mellow soil; and, unlike most kinds of garden vegetables, succeeds well when cultivated on the same land for successive years. The seed should be sown as early in the Spring as the ground is in good working condition, in drills 14 inches apart, and covered $\frac{1}{4}$ inch deep. Unless the plants stand very thick they need not be thinned out much, as they will crowd each other and find room to grow. Keep free from weeds, but be careful not to disturb the growing bulbs. A top dressing of wood ashes, applied after the second weeding, is very beneficial to this crop, as will soon be observed by the dark and healthy change of color given to the plants. The Onions will ripen early in September, and after being gathered and exposed to the sun for a few days for drying, they will be ready for storing or the market.

Ailsa Craig. Grows to a large size; very mild flavor; pale yellow. A valuable exhibition variety. Pkt. 25c., oz. \$1.00, $\frac{1}{4}$ lb. \$3.50.

Barletta. A very early, small, pure white variety, flesh firm and mild in flavor. Excellent for pickling. Pkt. 15c., oz. 60c., $\frac{1}{4}$ lb. \$2.00.

Cranston's Excelsior. Handsome globe-shaped variety; large, solid, with small neck; straw color. An exhibition variety. Pkt. 25c., oz. \$1.00.

Danvers Yellow Globe. Selected with the greatest care; the true shape and color; a reliable and sure cropper. Pkt. 15c., oz. 50c., $\frac{1}{4}$ lb. \$1.75.

Danvers Yellow Globe. Selected Strain. The finest type of this popular variety on the market. Grown for us by an Onion specialist in Danvers. Pkt. 25c., oz. \$1.00, $\frac{1}{4}$ lb. \$3.00.

Early Red Globe. Of beautiful shape; splendid quality and an excellent keeper. Pkt. 10c., oz. 50c., $\frac{1}{4}$ lb. \$1.75.

Giant White Italian Tripoli. An excellent, large, white Italian variety; of quick growth, mild and pleasant flavor. Pkt. 15c., oz. 60c., $\frac{1}{4}$ lb. \$2.25.

Gigantic Gibraltar. A handsome, straw-colored Onion of enormous size, possessed of many sterling qualities. Grand for exhibition. Pkt. 25c., oz. \$1.00.

Large Red Wethersfield. The leading red variety of the East; almost round; deep red color; grows to good size and is a good keeper. Pkt. 15c., oz. 60c., $\frac{1}{4}$ lb. \$2.00.

Mammoth Silver King. Of attractive shape, with silvery white skin and flesh of a most agreeable mild flavor. It matures quite early and frequently measures 20 inches in circumference. Pkt. 15c., oz. 75c., $\frac{1}{4}$ lb. \$2.50.

Prizetaker. Of a rich straw color and enormous size, averaging 12 to 14 inches in circumference. Although of such great size, it is very hard and an excellent keeper. Pkt. 15c., oz. 60c., $\frac{1}{4}$ lb. \$2.00.

Southport Red Globe. A good late sort. Keeps well. Pkt. 10c., oz. 50c., $\frac{1}{4}$ lb. \$1.50.

Southport Yellow Globe. A fine large variety. Somewhat later than the Danvers. Pkt. 15c., oz. 60c., $\frac{1}{4}$ lb. \$2.00.

The Queen. A handsome silver-skinned variety; esteemed for its rapid growth, mild flavor and fine keeping qualities. Pkt. 15c., oz. 75c., $\frac{1}{4}$ lb. \$2.50.

White Globe. Of mild flavor; good keeper. One of the best. Pkt. 15c., oz. 60c., $\frac{1}{4}$ lb. \$2.00.

White Portugal, or Silver Skin. Bulbs of medium size; flattened; skin silvery white; flesh fine grained and mild flavored. Pkt. 15c., oz. 60c., $\frac{1}{4}$ lb. \$2.00.

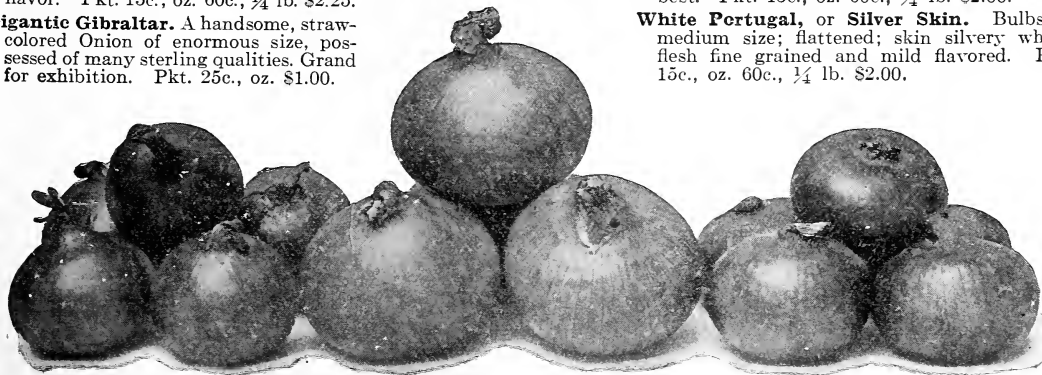

Southport Red Globe

Danvers Yellow Globe

Red Wethersfield

ONION SETS

Prices Variable

These are small Onions grown the previous year, ripened off and taken up when mere bulblets. They produce a very early crop, and grow in any good soil. Set them 3 or 4 inches apart in rows 1 foot apart. Potato Onions are generally grown from bulbs grown in clusters which are separated when planted.

If ordered by mail, add postage.

Shallots. Much used in soups, salads, etc. Qt. 50c.

Potato Onions, White (Multipliers). Pure silvery white; very productive and early, and keep remarkably well. Qt. 60c.

Potato Onions, Yellow. These are considered a little earlier than the white and yellow sets. Qt. 60c., pk. \$2.00.

White Sets. The best for general use, early, and of fine flavor. Qt. 40c., 4 qts. \$1.40, pk. \$2.75.

Yellow Sets. Preferred by some to white sets; not quite as mild flavored. Qt. 40c., 4 qts. \$1.40, pk. \$2.75.

Garlic, for flavoring, 50c. a lb.

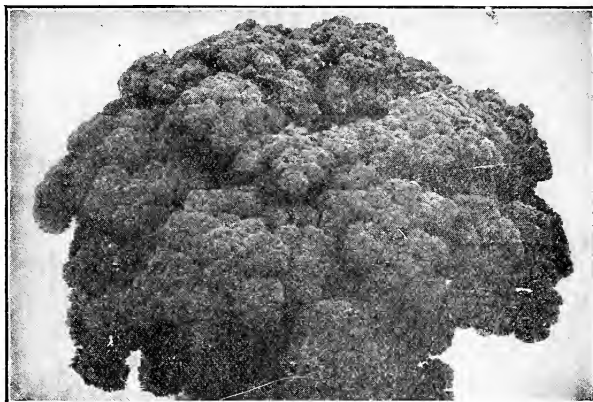

Grey's Perfection

PARSLEY

One ounce will sow 150 feet of drill.

Parsley succeeds best in rich, mellow soil, and as the seed germinates slowly—sometimes remaining in the earth four or five weeks before the plants appear—the sowing should be made as early in Spring as the ground is in working condition. Can also be sown in hotbed in February. When the plants are 2 or 3 inches high, thin them out to 8 or 10 inches apart. The leaves of the curled varieties are used for garnishing, also for flavoring soups and stews.

Double Curled. Dwarf, finely curled; excellent for table and edgings. Pkt. 10c., oz. 25c., $\frac{1}{4}$ lb. 75c.

Dobbie's Exhibition. This Parsley has long been recognized as a standard exhibition sort. It is remarkable for its large, fine leaves and close habit. The seed offered has been saved from selected plants only; every one was a perfect specimen. Pkt. 25c., oz. 75c.

Fern-leaved. Resembles crested fern or moss; grand for table decoration. Pkt. 10c., oz. 20c., $\frac{1}{4}$ lb. 60c.

Grey's Perfection. Beautifully curled and highly ornamental. Pkt. 25c., oz. 75c.

Hamburg, or Rooted. The roots are used for flavoring. Pkt. 10c., oz. 30c., $\frac{1}{4}$ lb. \$1.25.

Moss Curled. One of the finest varieties for garnishing on account of its mossy appearance and its bright color. Pkt. 10c., oz. 25c., $\frac{1}{4}$ lb. 75c.

PARSNIP

One ounce will sow 100 feet of drill. Five to six pounds to the acre.

Sow in April or early in May, as Parsnips require a long season to mature. Their cultivation is otherwise the same as directed for Carrots. They may be dug in the Autumn and stored for Winter use, but if left in the ground till the following Spring, they are very much improved in flavor. Sow a liberal quantity of seed, as from its nature it does not always come up well.

Arlington Long White. A good variety for general use; long and smooth. Pkt. 10c., oz. 25c., $\frac{1}{4}$ lb. 75c.

Early Round. The earliest variety in cultivation, of good flavor but of small size. Pkt. 10c., oz. 30c., $\frac{1}{4}$ lb. \$1.00.

Hollow-Crowned. Roots very long, white, smooth and sweet. Excellent flavor. Pkt. 10c., oz. 25c., $\frac{1}{4}$ lb. 75c.

Student. A favorite English variety; tender and smooth. Pkt. 10c., oz. 30c., $\frac{1}{4}$ lb. \$1.00.



Hollow-Crowned

PEAS

One quart will sow 100 feet of drill. One and one-half bushels per acre.

Peas succeed best in light, rich soil; dwarf varieties require liberal manuring, the tall varieties requiring less; they also succeed best under a low temperature. The early round, smooth varieties should be planted as early in Spring as possible, while the wrinkled sorts, which are more tender, will do better if planted after the ground becomes warmer. Sow in drills, 2 to 3 feet apart, according to variety, and cover early sowings about 2 inches; later plantings should be covered 3 to 4 inches. Make the drills deep enough to allow room for the manure, which should be scattered along the bottom of the drill and then covered thinly with soil before sowing the Peas, so that they will not come in contact with it. Successive plantings can be made every ten days up to the middle of July. For the later plantings the early varieties are preferred.

If ordered to go by mail, add Parcel Post rate to cover postage. We furnish 20c. Packages of all kinds of Peas, except where noted, free postage. One quart weighs about 2 pounds.

Early Varieties

Alaska, or Clipper. A superior blue-seeded variety, very early and productive. A valuable variety, either for private use or for market. Pods well filled. 2½ feet. Pt. 40c., qt. 75c., 4 qts. \$2.75.

Blue Bantam. A fine extra early, wrinkled Pea. Large pods well filled with deep green, fine flavored peas. Height 2¼ ft. Pt. 50c., qt. \$1.00, 4 qts. \$3.50.

Early Bird. A splendid early variety. This Pea matures as early as Laxtonian, seed blue, semi-wrinkled. Pods large and well filled. Height 16 inches. Pt. 40c., qt. 75c.

Early Morn. Of Gradus type. Early with large pods, and peas of good flavor. 3 ft. Pt. 50c., qt. 90c., 4 qts. \$3.50.

Gradus (Prosperity). Large, handsome pods, well filled, ripening with the earliest; pods long, straight, slightly rounded at the point. 3 ft. Pt. 45c., qt. 85c., 4 qts. \$3.25.

Grey's Perfection. One of the earliest Peas in cultivation; the pods, which are numerous, contain six or seven good-sized peas. Very productive and of fine flavor. 2½ feet. Pt. 40c., qt. 70c., 4 qts. \$2.50.

Hundredfold. A splendid large-podded dwarf variety; the pods are 4 inches long and well filled with large deep green Peas of fine quality. The vines grow 16 to 18 inches high and very strong; this is one of the best dwarf early Peas for the home garden and market. Pt. 65c., qt. \$1.00, 4 qts. \$3.50.

Laxton's Progress. This is the finest new early dwarf Pea Laxton has ever yet raised; wrinkled, averaging 9 to 10 peas in a pod. The pods are dark green, height 18 to 24 in. Pt. \$1.00, qt. \$1.50. Stock imported.

Laxtonian, Re-Selected. This fine new Pea has been carefully selected, and the stock now offered is saved from deep green, giant pods only. Pods are slightly curved and deep green peas are of excellent flavor. Pt. 50c., qt. 90c.

Little Marvel. This is one of the best among the dwarf Peas, being a heavy cropper and producing peas of best quality. Pods green, blunt-ended and well filled. Pt. 45c., qt. 85c., 4 qts. \$3.25.

Nott's Excelsior. An improvement on American Wonder, being more vigorous and prolific, with larger pods and more peas. Height 15 in. Pt. 40c., qt. 75c., 4 qts. \$2.75.

Pilot. An extra early round-seeded or smooth Pea. Can be planted as soon as ground can be worked. Pods as large as the Gradus. Very prolific, highly recommended as an extra early market sort. Pt. 50c., qt. 90c., 4 qts. \$3.50.

Sutton's Pioneer. A first early Pea which has won great popularity for its many excellent qualities. Height about 2 ft. Pt. 50c., qt. 90c.

Sutton's Excelsior. An extra early, dwarf, wrinkled Pea, fully as early as the American Wonder, with much broader pods, filled with large Peas of the finest flavor. 1½ ft. Pt. 50c., qt. 90c., 4 qts. \$3.50.



Peas, Laxtonian

Thomas Laxton. One of the best early wrinkled Peas yet introduced; very productive, with large, well-filled pods. 3 ft. Pt. 45c., qt. 80c., 4 qts. \$3.00.

World's Record. An earlier strain of the well-known Gradus Peas. The medium green, moderately stout vines, bearing medium green pods, 4 in. long, which are fairly broad, pointed, and well filled with from 7 to 9 very fine dark green Peas of exceptional quality. Pt. 50c., qt. 90c., 4 qts. \$3.50.

Second Early and Late Varieties

Alderman. A large-podded, wrinkled Pea of robust habit. Pods 4 to 5 in. long, well filled with peas of excellent flavor. 3½ ft. Pt. 40c., qt. 75c., 4 qts. \$2.75.

Admiral Beatty. A new and very popular variety, highly productive and of excellent quality. Height 4 ft., pods large, green and produced in pairs. Pt. 75c., qt. \$1.50.

Canada Field. See page 28.

Champion of England. A standard variety; very sweet and delicious. One of the best and most popular. 5 ft. Pt. 45c., qt. 80c., 4 qts. \$3.00.

Duke of Albany (American Champion). Immense pod on style of Telephone. 3 ft. Pt. 45c., qt. 85c., 4 qts. \$3.25.

PEAS—Continued.

Dwarf Champion. A dwarf form of popular Champion of England, with large pods, very productive, finest quality. 2 ft. Pt. 45c., qt. 80c., 4 qts. \$3.00.

Dwarf Telephone or Daisy. Season medium. Pods long, remarkably well filled, color pale green; peas large, tender and of delicious flavor. 1½ ft. Pt. 45c., qt. 80c.

Everbearing, Bliss'. A continuous bearing variety, which gives it especial value for late Summer and Autumn use. Pods 3 to 4 in. long, producing six to eight large, wrinkled peas; quality unsurpassed. 2 ft. Pt. 40c., qt. 75c., 4 qts. \$2.75.

French Canner (Petit Pois). Very prolific, with long, slim, curved pods, containing seven to nine Peas. 3 to 3½ ft. Pt. 55c., qt. 90c., 4 qts. \$3.50.

Heroine. A medium early green wrinkled Pea; large, recurved, showy pods; an immense cropper; finest quality. 2½ ft. Pt. 40c., qt. 75c., 4 qts. \$2.75.

Mammoth Melting Sugar. Best of all the edible-podded Peas. Pods straight, smooth, brittle and delicious. 3 ft. Pt. 50c., qt. \$1.00.

McLean's Advancer. A very early and prolific dwarf wrinkled Pea of finest quality. 2½ ft. Pt. 40c., qt. 75c., 4 qts. \$2.50.

Sutton's Super V. C. The largest podded Pea in existence; height from 5 to 6 ft. Large pods of fine flavor, and exhibition variety. Pt. \$1.00, qt. \$1.75.

The Britisher. A prolific, strong growing variety with medium green foliage. Pods are perfectly straight: pointed at the ends, and of a medium green color, containing nice large, nicely flavored Peas. 4 ft. Main crop; wrinkled. Pt. \$1.00, qt. \$1.75.

The Victor. A new main crop variety with large, well filled, deep green pods; height 2 ft.; heavy cropper. Pt. 60c., qt. \$1.00.

Quite Content, Carter. The largest and finest podded Pea in cultivation. Received First Class Certificate from the Royal Horticultural Society of London. A main crop variety; grows 5 feet high; foliage and pod deep green; pods 6 to 7 in. long, hanging mostly in pairs; ten to twelve Peas in a pod. Flavor superb. Pt. 60c., qt. \$1.00.

Stratagem. A dwarf, wrinkled, blue marrow; a heavy cropper, and produces large, remarkably well filled pods of excellent flavor. One of the best. 2 ft. Pt. 45c., qt. 85c., 4 qts. \$3.00.

Telephone. Immensely productive, of the finest quality and excellent sugary flavor, the pods are of large size and closely packed with large, delicious Peas. 4 ft. Pt. 50c., qt. 90c., 4 qts. \$3.50.

The Gladstone. One of the best late Peas; immense cropper, long curved, deep green, well-filled pods. 3½ ft. Pt. 50c., qt. 90c., 4 qts. \$3.50.

Yorkshire Hero. A large dwarf, wrinkled variety, of delicious flavor and great productivity. 2½ ft. Pt. 40c., qt. 75c., 4 qts. \$2.75.

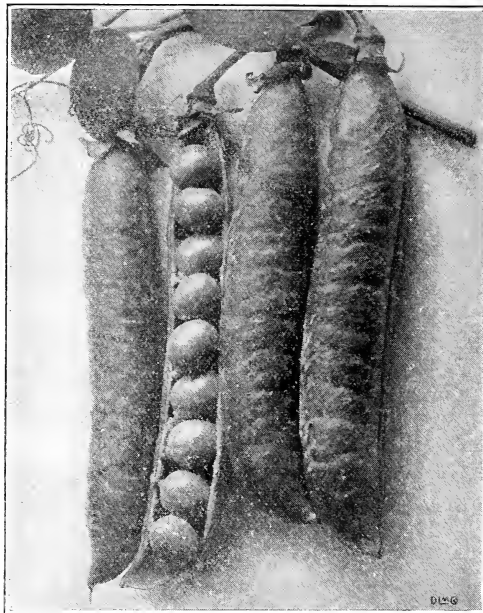

Duke of Albany (See page 17)

PEPPER

One ounce will produce about 1,500 plants

Sow in March or April in a hotbed and transplant into open ground late in May or early in June when the weather has become well settled, as the plants are quite tender. Set in rows about 2 feet apart, and 15 inches apart in the row. A warm, sandy loam is best suited to their growth.

Celestial. A useful as well as ornamental variety. Sets its fruit early and continues until frost. Pkt. 10c., oz. \$1.00, ¼ lb. \$3.75.

Chinese Giant. Very large, flesh mild and thick. Pkt. 10c., oz. \$1.00, ¼ lb. \$3.75.

Golden Dawn. A large yellow variety, resembling the bell in shape. Mild and sweet. Pkt. 10c., oz. 75c., ¼ lb. \$2.50.

Harris Early Giant. The largest Pepper grown; early and prolific. The plants produce enormous yield. The Peppers are 5 in. high and 3½ in. through; deep green turning to brilliant red. Flesh thick and of a very sweet flavor. Pkt. 25c., oz. \$1.75.

Large Bell, or Bull Nose. Good for Mangoes; early, sweet and less pungent than many; one of the best. Pkt. 10c., oz. 50c., ¼ lb. \$1.75.

Long Red Cayenne. A long, slim pod, rather pointed, and when ripe, of a bright red color, extremely strong and pungent. Pkt. 10c., oz. 75c.

Neapolitan Large Early. The earliest of the large, sweet Peppers. Pkt. 10c., oz. 75c., ¼ lb. \$2.50.

Ruby King. Long, about 5 in.; very thick; fine, mild flavor. Pkt. 10c., oz. 75c., ¼ lb. \$2.50.

Squash. Flesh thick, mild and pleasant to the taste, though more piquant than some. Pkt. 10c., oz. 85c., ¼ lb. \$3.00.

Sunnybrook. The fruit measures 2½ to 3 inches thick and 2 to 2½ deep. The skin is smooth and of a deep scarlet color. The flesh is unusually thick and very sweet. Pkt. 10c., oz. 75c., ¼ lb. \$2.50.

Sweet Mountain. Grows to large size; shape somewhat like the Bell, but much larger. Pkt. 10c., oz. 85c., ¼ lb. \$2.75.

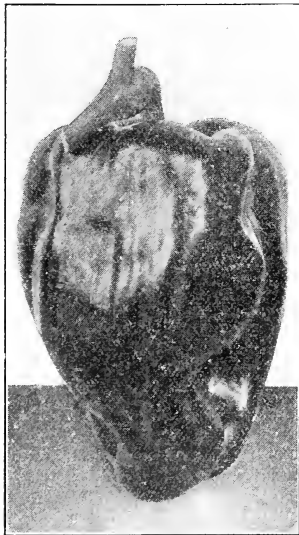

Neapolitan Pepper

POTATOES

Eight to ten bushels will plant one acre.

Owing to unsettled Market Conditions prices will be given on application.

A good, sandy loam produces the best Potatoes, but they can be grown on all kinds of soil. New or pasture land, with the turf freshly turned, produces the finest crop. Make furrows of good depth, 3 feet apart. Scatter a liberal dressing of phosphate or decayed stable manure along the drill, and set the seed about 10 inches apart in the rows. Cover with about 2 inches of soil, and begin to cultivate when the plants are well up. At each successive hoeing, bring additional soil about the plants. A change of seed is advisable.

Albino. Early white; a new, early variety and a good cropper. The skin and flesh are extremely white, maturing about the same time as Early Rose.

Beauty of Hebron. A very productive variety of fine quality; good either as an early or general crop Potato.

Bovee. Early and productive. Fine quality; flesh white and dry.

Delaware. Tubers large, smooth and of best quality; white and yields well.

Early Rose. The well-known variety; early and prolific.

Gold Coin. Tubers oblong, skin white; quality excellent, and a large yielder.

Green Mountain. We can recommend this variety as one of the best for all purposes.

Irish Cobbler. Cream white color and of excellent quality. A vigorous grower, early, ripens uniformly, and keeps well.

New Queen. Flesh white and quality good; early and productive. In shape and color it resembles the Beauty of Hebron.

Uncle Gideon's Quick Lunch Potato. The tubers are nearly globular in form; they run the most uniform in size, color, and quality of any extra early potato.

Spaulding Rose. A valuable early Potato of exceptional quality. Cooks white and mealy; does well in light soils.

PUMPKIN

One ounce will plant 20 hills. One pound 250 hills.

Sow in good soil in May, when the ground has become warm, in hills 8 or 10 feet apart each way; or in fields of Corn, about every fourth hill. The Pumpkin is not so particular in regard to soil as the Melon or Cucumber, but in other respects is cultivated in a similar manner. If planted in hills by themselves, thin out the plants when beginning to run, to three in each hill.

Connecticut Field. A large yellow variety, productive, and grown for feeding stock. Pkt. 10c., oz. 15c., $\frac{1}{4}$ lb. 50c., lb. \$1.50.

Mammoth. A productive variety, which grows to an immense size, often weighing more than a hundred pounds. Pkt. 10c., oz. 25c., $\frac{1}{4}$ lb. 75c., lb. \$2.50.

Sugar. A small fine-grained, sweet Pumpkin; very prolific and a fine table variety. Pkt. 10c., oz. 25c., $\frac{1}{4}$ lb. 50c., lb. \$1.75.

Winter Luxury. Flesh thick, sweet and excellent for pies. Pkt. 10c., oz. 25c., $\frac{1}{4}$ lb. 75c.

RADISH

One ounce will sow 100 feet of drill.

For very early use seeds can be sown in frames in February, making successive sowings every two or three weeks. Sow also in the open ground the last of April in light, rich, sandy soil, selecting a warm or sheltered location. Later sowings can be made at intervals during the Summer in a moist location where they can grow quickly. Sow broadcast or in drills. Seeds of Winter Radishes should be sown during Midsummer, and the Radishes can be kept during Winter if covered with sand and placed in a cool cellar.

Celestial. A quick growing radish either in the fall or spring. The flesh and skin white. Pkt. 10c., oz. 30c., $\frac{1}{4}$ lb. \$1.00.

Cincinnati Market. Long, smooth, slender, about 6 to 7 in. long, and $\frac{5}{8}$ in. in diameter at the shoulder. It is of a fine, deep red color and one of the best of the early long varieties. Pkt. 10c., oz. 25c., $\frac{1}{4}$ lb. 75c.

Early Crimson Giant. Grows to a large size without becoming pithy. Excellent for forcing. Pkt. 10c., oz. 25c., $\frac{1}{4}$ lb. 75c.

Earliest Forcing Deep Scarlet Turnip. Short leaved; very early; brilliant red; particularly fine for use in frames. Pkt. 10c., oz. 25c., $\frac{1}{4}$ lb. 75c.

Early Scarlet Globe. Of distinct shape, brilliant color, crisp and white; excellent for forcing. Pkt. 10c., oz. 30c., $\frac{1}{4}$ lb. \$1.00, lb. \$3.00.

Early Scarlet Turnip. Small, round Radish; very tender, mild and of quick growth. Pkt. 10c., oz. 25c., $\frac{1}{4}$ lb. 75c.,

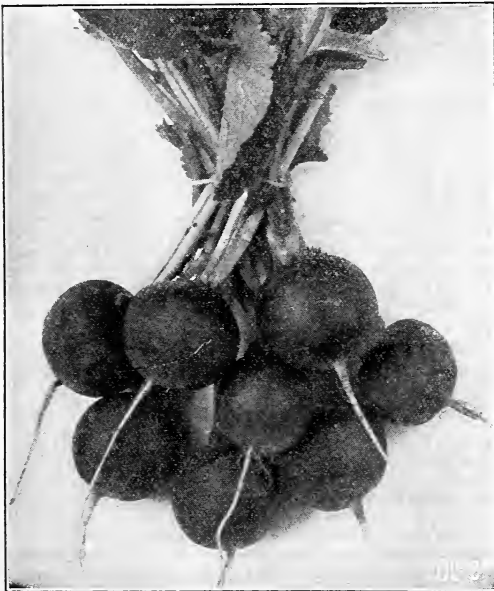

Early Scarlet Globe

RADISH—Continued

- Early, Scarlet Turnip, White Tipped.** A very early variety; color deep scarlet, with white tip. Good forcer. Pkt. 10c., oz. 25c., $\frac{1}{4}$ lb. 75c.
- French Breakfast.** Scarlet, with white tip; shape nearly oval; good for forcing or Summer sowing. Pkt. 10c., oz. 20c., $\frac{1}{4}$ lb. 75c.
- Icele.** Quick growing; clear white. Fine for forcing. Pkt. 10c., oz. 30c., $\frac{1}{4}$ lb. 80c.
- Long Black Spanish.** One of the hardiest and best for Winter use. Pkt. 10c., oz. 20c., $\frac{1}{4}$ lb. 60c.
- Olive-Shaped Scarlet.** A very handsome, quick growing variety; excellent quality. Pkt. 10c., oz. 35c., $\frac{1}{4}$ lb. \$1.25.
- Round Black Spanish.** Skin black; roots globe-shaped; white fleshed and piquant flavor. Pkt. 10c., oz. 20c., $\frac{1}{4}$ lb. 60c.
- Rose China Winter.** Bright rose color, flesh firm and fine for Winter use. Pkt. 10c., oz. 25c., $\frac{1}{4}$ lb. 75c.
- Sakurajima.** Largest sort in cultivation. Sow early in rich soil. Pkt. 10c., oz. 35c., $\frac{1}{4}$ lb. \$1.25.
- White Turnip.** Very early, flesh and skin white, of mild flavor, excellent for Summer use. Pkt. 10c., oz. 20c., $\frac{1}{4}$ lb. 60c.
- White Strasburg.** Roots oblong, of a pure white color and mild flavor. Pkt. 10c., oz. 25c., $\frac{1}{4}$ lb. 75c.
- White Stuttgart.** A quick growing variety of large size and of good quality. Pkt. 10c., oz. 30c.

RHUBARB

One ounce will produce about 750 plants.

Rhubarb succeeds best in deep, rich loam; the richer its condition, and the deeper it is stirred, the better, as it is scarcely possible to cultivate too deeply or to manure too highly. It is propagated by seeds, or by division of the roots—the latter being the usual method. Sow the seed in drills 18 inches apart, and thin out the plants to 9 inches apart in the drills. When the plants are one year old transplant into beds, setting the plants 5 feet apart each way. Do not cut until the second year and give a liberal dressing of manure every Fall.

Linnaeus. The earliest and best for garden use; not as coarse and fibrous as the larger sorts. Pkt. 10c., oz. 50c., $\frac{1}{4}$ lb. \$1.00.

Victoria. The variety in general use for the market; yields immense crops. Pkt. 10c., oz. 60c., $\frac{1}{4}$ lb. \$1.25.
Roots. Either variety; each 25c., doz. \$2.75.

SALSIFY, or VEGETABLE OYSTER

One ounce will sow 50 feet of drill.

A very delicate and nutritious vegetable, especially esteemed for its peculiar oyster flavor. Sow the seed early in Spring, in drills 12 inches apart and 1 inch deep, thinning out the young plants to 6 inches. The roots will be ready for use in October, when a supply should be taken up and stored like Carrots. Those remaining will suffer no injury by being left in the ground till Spring.

Long White French. Pkt. 10c., oz. 35c., $\frac{1}{4}$ lb. \$1.25.

Mammoth Sandwich Island. Tender and delicious; very superior. Pkt. 10c., oz. 30c., $\frac{1}{4}$ lb. \$1.00.

Spanish Salsify (*Scolymus Hispanicus*). Golden Thistle or Spanish Oyster Plant, large size and very productive; mild flavor. Pkt. 20c., oz. 60c.

SPINACH

One ounce will sow 50 feet of drill. Twenty pounds will sow an acre.

Spinach may be grown on any ordinary soil. It is grown both as a Spring and Summer crop. For early use sow in August or September, in drills 12 to 14 inches apart. At the approach of cold weather cover lightly with straw, or any handy litter. Uncover when the plants begin to make a new growth in Spring. For Summer use sow early in Spring, in same way as above, using rather less seed. If the plants stand too thick, thin to 3 or 4 inches apart. A liberal dressing of good manure should be used. The land can hardly be made too rich.

Packets 10c. except where noted.

Bloomsdale or Savoy-leaved. A valuable variety with wrinkled leaves, resembling the Savoy Cabbage; it is very hardy and prolific. Oz. 15c., $\frac{1}{4}$ lb. 35c., lb. \$1.25.

King of Denmark. Especially desirable for sowing during April and May. Oz. 15c., $\frac{1}{4}$ lb. 35c., lb. \$1.25.

Long Standing. Dark green; the longest standing before running to seed. Oz. 10c., $\frac{1}{4}$ lb. 30c., lb. \$1.00.

New Zealand (*Tetragonia expansa*). A plant of a different genus, but of similar character and use as Spinach. May be started in a hotbed and transplanted or sown out of doors when the ground is warm, allowing two feet between the plants. Pkt. 10c., oz. 25c., $\frac{1}{4}$ lb. 85c., lb. \$2.50.

Perpetual or Spinach Beet. Producing green leaves in abundance close to the ground. This variety will give a constant supply of Spinach throughout the season. Pkt. 10c., oz. 25c., $\frac{1}{4}$ lb. 85c.

Princess Juliana. The leaves are large; very dark green in color; thick in texture and very much blistered; does not quickly run to seed. A fine variety for the market. Pkt. 10c., oz. 35c., $\frac{1}{4}$ lb. \$1.00, lb. \$2.50.

Round Thick-Leaved. Leaves large, thick and fleshy; the variety generally grown for market and equally good for Spring or Fall sowing. Oz. 15c., $\frac{1}{4}$ lb. 30c., lb. \$1.00.

Savoy Blight-resisting. On account of its resistance to blight, the yield is often very large. A valuable variety to use for Fall sowing. Oz. 15c., $\frac{1}{4}$ lb. 35c.

Savoy-leaved, long-standing. Darker green and more heavily crumpled than Bloomsdale, will stand ten days longer before bolting to seed. Oz. 15c., $\frac{1}{4}$ lb. 35c.

Victoria. Large, thick, dark green leaves; excellent for Spring sowing; heavy cropper; long standing and excellent quality. Oz. 15c., $\frac{1}{4}$ lb. 35c., lb. \$1.25.

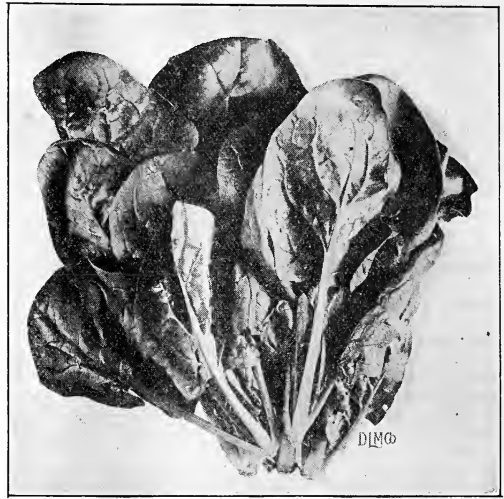

Spinach, Victoria



Hubbard

Bay State

Delicious

SQUASH

One ounce of the small-seeded variety will plant 40 hills; of large-seeded, 15 hills.

Squashes, being very tender and sensitive to cold, should not be planted until the weather becomes warm and settled. Plant in well-matured hills, in the same manner as Cucumbers and Melons, the bush varieties 3 or 4 ft. apart each way, and the running kinds from 6 to 8 ft. apart. Sow 8 to 10 seeds to a hill, thinning out after they have attained their rough leaves, and danger from bugs is past, leaving two or three of the strongest plants in each hill.

Bay State. Blue, shell hard; flesh fine and dry, of sweet flavor; bright golden yellow color. Pkt. 10c., oz. 35c., $\frac{1}{4}$ lb. \$1.00.

Boston Marrow. A Fall and Winter variety of oval form, skin thin; when ripe, bright orange; an excellent keeper and of superior quality. Pkt. 10c., oz. 35c., $\frac{1}{4}$ lb. 1.00.

Delicious. One of the best varieties for table use. It is a Fall and Winter Squash, excellent at all seasons. Pkt. 10c., oz. 25c., $\frac{1}{4}$ lb. 75c.

Des Moines. It is a small, dark green, acorn-shaped Squash, almost black in color, with deep ridges, hard shell, dry meat, small seed cavity, usually about 6 in. long and 4 in. in diameter. When fully matured it is an excellent keeper, therefore one of the best for home garden. Pkt. 15c., oz. 50c., $\frac{1}{4}$ lb. \$1.50.

Early Mammoth, White Scalloped. One of the earliest Summer Squashes; flat scallop-shaped; light cream color. Pkt. 10c., oz. 20c., $\frac{1}{4}$ lb. 75c.

Early Prolific, or Orange Marrow. The earliest and most productive Fall and Winter Squash; color bright orange, flesh dry and sweet. Pkt. 10c., oz. 25c., $\frac{1}{4}$ lb. 75c.

Early Giant Summer Crookneck. Very early variety; long shape and of a bright yellow color. Pkt. 10c., oz. 25c., $\frac{1}{4}$ lb. 75c., lb. \$2.50.

Essex Hybrid Turban. Productive, with very hard shell; a solid, heavy, thick-fleshed sort of excellent flavor, and keeps admirably. Pkt. 10c., oz. 35c., $\frac{1}{4}$ lb. \$1.25.

Giant Straight Neck Summer. This is a new type, produced by one of New England's leading market gardeners. By careful selection he has produced a type nearly double the size of any other Summer Squash. Despite its large size the flesh is rich and fine flavored. Its attractive appearance has made it popular with the

market gardeners. We believe this new variety will eventually replace all other Summer varieties. Pkt. 25c., oz. 75c., $\frac{1}{4}$ lb. \$2.50, lb. \$9.00.

Hubbard. Standard Winter Squash; grown more extensively than any other late variety; color, dark green, shell extremely hard; flesh dry, fine grained and sweet; excellent keeper. Pkt. 10c., oz. 25c., $\frac{1}{4}$ lb. 75c., lb. \$2.50.

Hubbard, Mammoth Warted. A superior strain of mammoth size and entirely covered with warty excrescences. Rich, dark green color and of very best quality. Pkt. 10c., oz. 25c., $\frac{1}{4}$ lb. 75c., lb. \$2.50.

Hubbard, Golden. Earlier than Hubbard; color a rich orange red; shell hard and warty. Pkt. 10c., oz. 25c., $\frac{1}{4}$ lb. 75c., lb. \$2.50.

Hubbard, Symmes Blue. A superior strain, thick meated, fine grained, dry and very sweet. A heavy cropper and good keeper. Pkt. 15c., oz. 40c., $\frac{1}{4}$ lb. \$1.50.

Marblehead. Resembles Hubbard, but is earlier; has a gray, hard shell; good Winter sort. Pkt. 10c., oz. 25c., $\frac{1}{4}$ lb. 75c., lb. \$2.50.

The Warren. Resembles the Essex Hybrid but has a shell generally harder and thicker. The color is of a richer and deeper orange. The flesh is of excellent quality. Pkt. 10c., oz. 50c., $\frac{1}{4}$ lb. \$1.50.

Vegetable Marrow, English. Grows about 9 inches long. Pale straw-colored, changing to a deeper shade. Flesh white. Pkt. 15c., oz. 30c., $\frac{1}{4}$ lb. \$1.00.

Vegetable Marrow, Italian (Cocozelle di Napoli). Skin smooth, mottled, dark and light green. Grows from 12 to 20 inches long. Flesh delicate green; quality fine. Pkt. 15c., oz. 30c., $\frac{1}{4}$ lb. \$1.00.



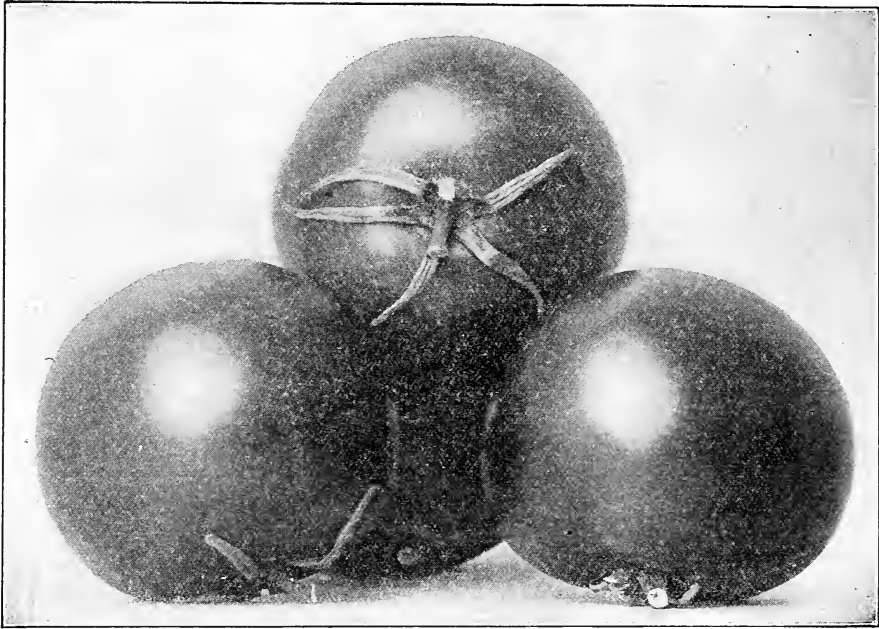

Tomato, Lister's Prolific—See page 23

TOMATO

One ounce will produce 1500 plants

Seed should be sown in a hotbed about the first week in March, in drills 5 inches apart. When the plants are about 2 inches high they should be set out 4 or 5 inches apart in another hotbed, or removed into small pots, allowing a single plant to a pot. About the middle of May the plants may be set out in the open ground; they are planted for early crops on light, sandy soil, at a distance of 3 feet apart, in hills in which a good shovelful of rotted manure should be mixed. On heavy soil, which is not suited for an early crop, they should be planted 4 feet apart. Water freely at the time of transplanting, and shelter from the sun for a few days until the plants are established.

Ailsa Craig. One of the best forcing varieties, also does well outdoors; a heavy cropper. Fruit medium size, smooth and of a rich scarlet color. Pkt. 25c.

Beauty, Livingston's. Rich, glossy crimson; large size, very smooth and solid. Pkt. 10c., oz. 50c., $\frac{1}{4}$ lb. \$1.50.

Belmont, Improved. An excellent scarlet variety. Early, medium size; solid and smooth. Pkt. 10c., oz. 60c., $\frac{1}{4}$ lb. \$2.00.

Best of All, Sutton's. A good forcing or outdoor variety; deep scarlet; solid. Pkt. 25c., oz. \$2.00.

Bonny Best. Early, productive. Smooth, solid and uniform in size; scarlet. Pkt. 10c., oz. 50c., $\frac{1}{4}$ lb. \$1.50.

Bountiful, Re-selected. A Tomato of superior flavor, perfect in shape; of good size and free cropper. The fruit is bright red in color and very solid, excellent for forcing or outdoor culture. Pkt. 20c., oz. \$1.50.

Carter's Sunrise (True Stock). One of the best Tomato for indoor or outdoor cultivation. Perfect in shape, of good size and free cropper; the fruit is bright red. Pkt. 25c., oz. \$1.75.

Chalk's Early Jewel. Large, solid, smooth, bright red variety. Pkt. 10c., oz. 50c., $\frac{1}{4}$ lb. \$1.50.

Cherry Red. Small, round fruit, resembling Cherries; for preserving. Pkt. 10c., oz. 50c.

Comet. One of the best for forcing; brilliant scarlet color; medium size, smooth and solid. Pkt. 25c., oz. \$2.00.

Crockford's Alaska, or "New Trellis." Without doubt the finest forcing Tomato on the market, also the best for outdoor if grown on trellises. Rich, deep color, solid flesh. Pkt. 50c.

Currant, or Grape. Fruit very small, bright red, in clusters. Pkt. 10c., oz. 50c.

Dwarf Champion. Of compact, upright growth. Fruit solid, smooth, purplish-red. Pkt. 10c., oz. 40c., $\frac{1}{4}$ lb. \$1.25.

Dwarf Stone. Resembles Dwarf Champion; fruit larger and more prolific; fine color. Pkt. 10c., oz. 40c., $\frac{1}{4}$ lb. \$1.25.

Earliana. The earliest red Tomato. Very smooth; fine for market. Pkt. 10c., oz. 40c., $\frac{1}{4}$ lb. \$1.25.

Favorite, Livingston's. A superior Tomato. Bright red, smooth, solid and of good size. Pkt. 10c., oz. 50c., $\frac{1}{4}$ lb. \$1.50.

Golden Ponderosa. A large golden yellow variety of excellent quality. Pkt. 15c., oz. 75c., $\frac{1}{4}$ lb. \$2.50.

Golden Queen. The best yellow variety, medium size smooth and solid. Pkt. 10c., oz. 40c., $\frac{1}{4}$ lb. \$1.25.

Globe Livingston's. Very early; large, smooth variety. Pkt. 10c., oz. 40c., $\frac{1}{4}$ lb. \$1.25.

TOMATO—Continued

- JohnsBaer.** An early bright scarlet new Tomato. Large and fleshy. Pkt. 15c., oz., 50c., $\frac{1}{4}$ lb. \$1.50.
- Lister's Excelsior.** This variety is the result of a cross between Ailsa Craig and Lister's Prolific; one of the best for forcing or outdoor culture; a heavy cropper of good flavor and color. Original pkts. 35c.
- Lister's Prolific.** This variety combines all the essential qualities of productiveness, size, flavor and color; whether planted out or grown in a greenhouse it has proved a remarkably valuable variety. Pkt. 35c.
- Lister's Protection.** A new variety—the best of Lister's productions. Color dark crimson, a heavy cropper, perfect in shape and size. Pkt. 75c.
- Mystic Beauty, "Crockford's."** A cross between Bonny Best and Alaska, fully as large as Bonny Best; ripens 10 days earlier, and of a much deeper color. One of the best outdoor varieties. Should be grown on stakes. Seed limited. Pkt. 50c.

- Peach.** For preserves, pickles, etc. Resembles a Peach in color. Pkt. 10c., oz. 40c.
- Perfection, Livingston's.** An early variety, of blood-red color; perfectly smooth; ripens uniformly, and bears abundantly until frost; excellent for canning. Pkt. 10c., oz. 40c., $\frac{1}{4}$ lb. \$1.25.
- Ponderosa.** Very large, solid and of excellent flavor. Pkt. 10c., oz. 50c., $\frac{1}{4}$ lb. \$1.50.
- Scott's Ellenbank.** A new variety, very large cropper, carrying trusses from 3 to 4 lbs. One of the best Tomatoes for indoor or outdoor cultivation. Pkt. 75c.
- Stirling Castle.** This is one of the best for indoor culture. Round, smooth, delicious flavor. Pkt. 25c. $\frac{1}{4}$ oz. \$1.00, oz. \$3.00.
- Stone Livingston's.** Large, bright scarlet, solid, smooth, later than many, very productive. Pkt. 10c., oz. 40c. $\frac{1}{4}$ lb. \$1.50.
- Yellow Plum.** Bright lemon-colored, oval, small; useful for preserves. Pkt. 10c., oz. 40c., $\frac{1}{4}$ lb. \$1.25.

TOBACCO

- Connecticut Seed-leaf.** Suited to the climate of the Northern and Middle States. Pkt. 10c., oz. 75c.
- Havana.** Imported seed. Pkt. 10c., oz. 75c.

TURNIP

One ounce will sow 150 feet of drill; $1\frac{1}{2}$ lbs. per acre.

Turnips do best in highly enriched, light, sandy or gravelly soil; sow the earliest varieties as soon as the ground can be worked in the Spring, in drills 12 to 18 inches apart. Seed can also be sown broadcast, using one pound to the acre. For a continuous supply through the season, sowings should be made every two weeks until the last of July, from which time until the middle of August the principal sowings are made for Fall and Winter use. Swedish or Rutabaga Turnips are largely grown for a farm crop, as well as for the table; make sowings from the 10th of June until the last of July, in drills 2 to 3 feet apart, and the plants when well up should be thinned to from 8 to 10 inches apart. They are best preserved in a pit or cellar during the Winter, and are excellent for the table early in Spring.

- Extra Early Milan, White.** A beautiful early variety, with small tops, tender and sweet. Pkt. 10c., oz. 35c., $\frac{1}{4}$ lb. \$1.00.
- Golden Ball.** Bulb of fine form and bright yellow color; a fine keeper; unsurpassed for table use. Pkt. 10c., oz. 25c., $\frac{1}{4}$ lb. 75c., lb. \$2.50.
- Milan Early, Purple Top.** The earliest of the white flesh varieties. Pkt. 10c., oz. 25c., $\frac{1}{4}$ lb. 75c.
- Nonsuch.** A purple top variety of great merit, has been carefully selected and improved. The roots grow to a large size and are of the finest quality. A very heavy cropper. Oz. 35c., $\frac{1}{4}$ lb. \$1.00.
- Purple Top Strap-leaf.** A well-known variety, extensively grown both for table and for stock. Pkt. 10c., oz. 25c., $\frac{1}{4}$ lb. 75c., lb. \$2.50.
- Purple Top White Globe.** A handsome, globe-shaped variety, valuable for market purposes. Pkt. 10c., oz. 20c., $\frac{1}{4}$ lb. 50c., lb. \$1.50.
- Seven Top.** This variety extensively grown for winter greens. Oz. 20c., $\frac{1}{4}$ lb. 50c.
- White Egg.** Oval-shaped variety for Spring or Fall sowing; flesh white, firm, fine-grained, mild and sweet. Pkt. 10c., oz. 20c., $\frac{1}{4}$ lb. 40c., lb. \$1.00.
- Yellow Aberdeen.** Hardy, productive and a good keeper; yellow, flesh firm, good for table use or feeding stock. Pkt. 10c., oz. 25c., $\frac{1}{4}$ lb. 75c., lb. \$2.50.

- Monarch.** A deep yellow-fleshed, purple top variety, smooth, oval form, slightly tapering at ends; small neck and fine for table use. Pkt. 10c., oz. 25c., $\frac{1}{4}$ lb. 75c., lb. \$2.00.
- Snowball.** A very early pure white variety of medium size. Pkt. 10c., oz. 25c., $\frac{1}{4}$ lb. 75c.
- Shamrock.** An excellent variety; grows with small top and very few leaves; a good keeper; desirable either for stock or table use. Pkt. 10c., oz. 15c., $\frac{1}{4}$ lb. 50c., lb. \$1.25.
- White Cape Cod.** A superior variety for table or stock; flesh firm, sweet and juicy. Pkt. 10c., oz. 25c., $\frac{1}{4}$ lb. 75c., lb. \$2.00.
- White French.** Oval in form, clear white flesh; one of the best Winter Turnips. Pkt. 10c., oz. 20c., $\frac{1}{4}$ lb. 40c., lb. \$1.00.

Rutabaga, or Swedish Turnip

- Budlong Swede.** A choice strain of the white Rutabaga, earlier than others, and more nearly round in form. Sweet, of excellent flavor and keeps well. Pkt. 10c., oz. 15c., $\frac{1}{4}$ lb. 40c., lb. \$1.00.
- Carter's Imperial.** An excellent sort, for either table use or feeding stock. Flesh yellow, solid, firm, sweet and rich. Pkt. 10c., oz. 15c., $\frac{1}{4}$ lb. 40c., lb. \$1.00.
- Improved American, Purple Top.** A yellow-fleshed, purple top variety grown for stock or table. Pkt. 10c., oz. 20c., $\frac{1}{4}$ lb. 50c., lb. \$1.25.

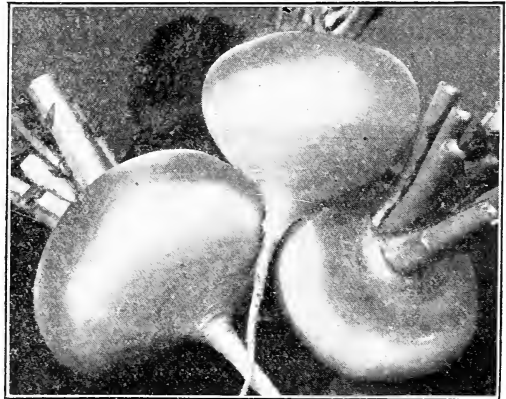

Turnip, Purple Top Strap-leaf

Pot, Sweet and Medicinal Herbs

Plant in the Spring when the ground is warm, in drills, covering lightly. When the plants are well up, thin out or transplant to about 4 inches apart. They should be harvested on a day just before the blossom develops, dried quickly and bottled, or closely packed in dry boxes with the air entirely excluded.

- Anise** (Pimpinella Anisum). Annual. Used for flavoring and garnishing. Pkt. 10c., oz. 60c.
- Arnica** (Arnica Montana). Perennial. Used in medicine as a narcotic and stimulant. Pkt. 10c., oz. \$2.00.
- Balm** (Melissa Officialis). Perennial. Leaves have a fragrant odor and are used medicinally. Pkt. 15c., oz. \$1.00.
- Basil, Sweet** (Ocimum Basilicum). Annual. Used for flavoring soups, stews, etc. Pkt. 10c., oz. 60c.
- Borage** (Borago Officialis). Annual. Leaves are used for flavoring, and bees are attracted by the flowers. Pkt. 10c., oz. 40c.
- Caraway** (Carum Carui). Perennial. Used for flavoring confectionery, bread, etc. Pkt. 10c., oz. 30c.
- Catnip** (Nepeta Cataria). Perennial. Sometimes used in medicine. Pkt. 25c.
- Coriander** (Coriandrum Sativum). Annual. Used in the manufacture of confectionery and liquors. Pkt. 10c., oz. 40c.
- Dill** (Anethum Graveolens). Biennial. The seeds are aromatic and pungent. Used in pickling Cucumbers. Pkt. 10c., oz. 50c.
- Fennel, Sweet** (Anethum Foeniculum). Perennial. Leaves when boiled are used in sauces. Pkt. 15c., oz. 50c.
- Fennel, Florence** (Anethum Foeniculum). The roots are boiled, also used as salad. Pkt. 15c., oz. 50c.
- Horhound** (Marrubium Vulgare). Perennial. Used medicinally, also for seasoning. Pkt. 10c., oz. 50c.
- Hyssop** (Hyssopus Officialis). Perennial. Used medicinally. The leaves have a pungent taste. Pkt. 10c., oz. 60c.

- Lavender** (Lavandula Vera). Perennial. Yields an oil used in medicine and perfumery. Pkt. 25c., oz. \$1.00.
- Loveage** (Levisticum Officinale). Perennial. An aromatic stimulant used in medicine. Pkt. 25c., oz. \$1.00.
- Marjoram, Sweet** (Origanum Majorana). Annual. Aromatic and fragrant. Much used in flavoring. Pkt. 10c., oz. 80c.
- Pennyroyal** (Hedeoma Pulegioides). Annual. An aromatic medicinal herb. Pkt. 15c., oz. \$1.00.
- Rosemary** (Rosmarinus Officinalis). Perennial. Leaves fragrant, with warm, pungent, bitterish taste. Pkt. 25c.
- Rue** (Ruta Graveolens). Perennial. Has a strong, heavy odor and bitter taste. Used medicinally. Pkt. 15c., oz. \$1.00.
- Saffron** (Carthamus Tinctorius). Annual. Flowers are used as a dyestuff and in making rouge. Pkt. 10c.
- Sage** (Salvia Officialis). Perennial. More used than any other herb for dressings, and seasoning. Pkt. 10c., oz. 50c.
- Sorrel** (Rumex Crispus). Perennial. Used for salads or cooked and served as Spinach. Pkt. 10c., oz. 80c.
- Summer Savory** (Satureja Hortensis). Annual. Used for flavoring soups and dressings. Pkt. 10c., oz. 30c.
- Thyme** (Thymus Vulgaris). Perennial. Used for seasoning. Also used medicinally. Pkt. 25c., oz. \$2.00.
- Wormwood** (Artemisia Absinthium). Perennial. Used medicinally and is beneficial for poultry. Pkt. 25c.

Vegetable Roots and Plants

We do not send Vegetable Plants by mail except where noted.

- ASPARAGUS.** 100
 "Reading Giant." Strong two-year-old roots..\$2.50
 Martha Washington..... 3.00
 Mary Washington..... 3.25
- ARTICHOKE, Jerusalem.** Qt. 40c., by mail 10c. additional; pk. \$2.50.
- ARTICHOKE PLANTS, Green Globe.** May delivery.
 Doz. \$2.50.
- BRUSSELS SPROUTS PLANTS.** Doz. 100 \$0.30 \$1.50
- CABBAGE PLANTS.**
 Early Jersey Wakefield..... 30 1.50
 Fottler's Brunswick..... 30 1.50
 Globe Curled Savoy..... 30 1.50
 Henderson's Summer..... 30 1.50
 Stone Mason..... 30 1.50
- CAULIFLOWER PLANTS.**
 Earliest Erfurt..... 30 2.00
 Early Snowball..... 30 2.00
- CELERY PLANTS, by mail add 10c. per 100.**
 Boston Market..... 25 1.25
 Golden Self-Blanching..... 25 1.25
 Giant Pascal..... 25 1.25

- CHIVES.** Per bunch 30c. each by mail 10c. additional.
- EGG PLANTS.** Doz. 100
 Black Pekin.....\$1.00 \$7.00
 New York Improved..... 1.00 7.00
- HORSE RADISH.** Sets or cuttings..... .30 1.75
- LETTUCE PLANTS.**..... .25 1.25
- MINT.**..... Each 15c. 1.50
- PEPPER PLANTS.**..... .50 3.00
- RHUBARB ROOTS.** Each Doz.
 Linnæus. Large and early.....\$0.25 \$2.75
 Victoria. Largest variety..... .25 2.75
 Clumps. Of either variety..... .50
- TARRAGON PLANTS** (Estragon). Strong plants. Each 50c., by mail 5c. additional... 5.00
- TOMATO PLANTS** (Pot-grown).
 Belmont..... 2.00 7.00
 Bonny Best..... 1.00 7.00
 Dwarf Champion..... 1.00 7.00
 Perfection, Livingston's..... 1.00 7.00
 Stone, Livingston's..... 1.00 7.00



Winter Rye

CEREALS and MISCELLANEOUS SEEDS

Great care is used in the selection of our seed corn, grain, etc. The prices are those ruling at the time of issuing this list and may change with the market. If ordered by mail add postage at parcel post rates.

FIELD CORN

- Brewer's Yellow Dent Corn.** It is claimed to be the earliest high-yielding variety of Yellow Dent Corn in existence. Grows from 9 to 10 ft. high, ears average about 10 in. long, $7\frac{1}{2}$ in. in circumference, and bear about 22 rows of kernels, with about 50 kernels in a row. Pk. \$1.50, bu. \$5.00.
- Early Sanford.** Ears white, makes a fine quality of meal; good for fodder and ensilage. Pk. \$1.25, bu. \$4.00.
- Evergreen Sweet Fodder.** For cutting green and feeding to stock this variety excels all others in tenderness, sweetness and nutriment. Pk. \$1.75, bu. \$6.00.
- Early Canada.** One of the earliest yellow varieties; ear small; in ordinary seasons the crop will be fully ripened in August. Pk. \$1.00, bu. \$3.00.
- Leaming.** Yellow Dent variety, with large, deep grain of dark orange color; excellent for ensilage. Pk. \$1.00, bu. \$3.75.

- Longfellow.** The standard variety in this section; long ear, small cob, bright yellow color, and medium early. Pk. \$1.00, bu. \$3.50.
- Pennsylvania Sweepstake Corn.** This variety of corn will mature quicker than any other variety; the foliage extends to the ground and the stalks are sturdy and tall. A heavy cropper. Pk. \$1.75, bu. \$6.00.
- Pride of the North.** The earliest Yellow Dent Corn in cultivation; a safe sort for high latitudes. Pk. \$1.00, bu. \$3.75.
- Stickney.** Similar to Longfellow in shape and color, but earlier and more prolific. Pk. \$1.25, bu. \$4.00.
- Eureka.** Grows from 10 to 15 ft. high and produces a rich, heavy growth. Pk. \$1.50, bu. \$5.00.

SEED GRAIN

Prices subject to change with the market.

- Great care is used in the selection of our seed grain. We endeavor to have each kind true to name and free from mixture and fowl seeds. Samples and special quotation for large quantities sent on request.
- BARLEY.** Sow $1\frac{1}{2}$ to 2 bus. per acre. (48 lbs. per bu.)
- Beardless.** Bu. \$2.75.
- Montana.** Choice seed. Bu. \$2.75.
- BUCKWHEAT.** Sow 1 bu. per acre. (48 lbs. per bu.)
- Japanese.** Very prolific. Bu. \$2.75.
- Silver Hull.** Makes fine white flour. Bu. \$3.00.
- OATS.** Sow 2 to 3 bus. per acre. (32 lbs. per bu.)
- Canadian Cluster.** Heavy, with stiff straw; yields well. Bu. \$1.75.
- Montana.** A choice white variety. Bu. \$3.00.
- Welcome.** A very productive white variety, with extra strong, straight straw. Bu. \$1.75.
- RYE.** Sow $1\frac{1}{2}$ bus. per acre. (56 lbs. per bu.)
- Spring.** For Spring sowing. Bu. \$3.00.
- Winter.** For Fall sowing. Bu. \$3.00.
- WHEAT.** Sow $1\frac{1}{2}$ bus. per acre. (60 lbs. per bu.)
- Spring. Marquis.** Bu. \$3.50.
- Winter. Klondyke Bald.** White grain. Bu. \$4.50.

MILLETS

Prices subject to change with the market.

- Valuable for green fodder or hay, maturing in 50 to 75 days from the time the seed germinates, producing an abundant yield of forage, relished by all kinds of stock; should be sown in June and July. They must be cut while in blossom to make a good hay.
- German, or Golden.** A valuable annual hay and fodder crop, more productive and coarser than the Hungarian. Medium early, 4 to 5 feet high. Sow 1 bu. to the acre Bu. \$5.00.
- Japanese (Panicum Crus-galli).** Grows taller and stools out more freely than the common Millet; very productive. If sown early and cut, usually produces a good second crop. It has produced in Massachusetts six tons dry hay per acre; highly recommended. Sow 20 lbs. per acre. Lb. 15c., 100 lbs. \$12.00.
- Hungarian Millet (Panicum germanicum).** An annual forage plant, early and productive, growing 2 to 3 ft. high, with an abundance of foliage, often yielding 2 to 3 tons per acre. Sow 1 bu. to the acre. Bu. \$5.00.

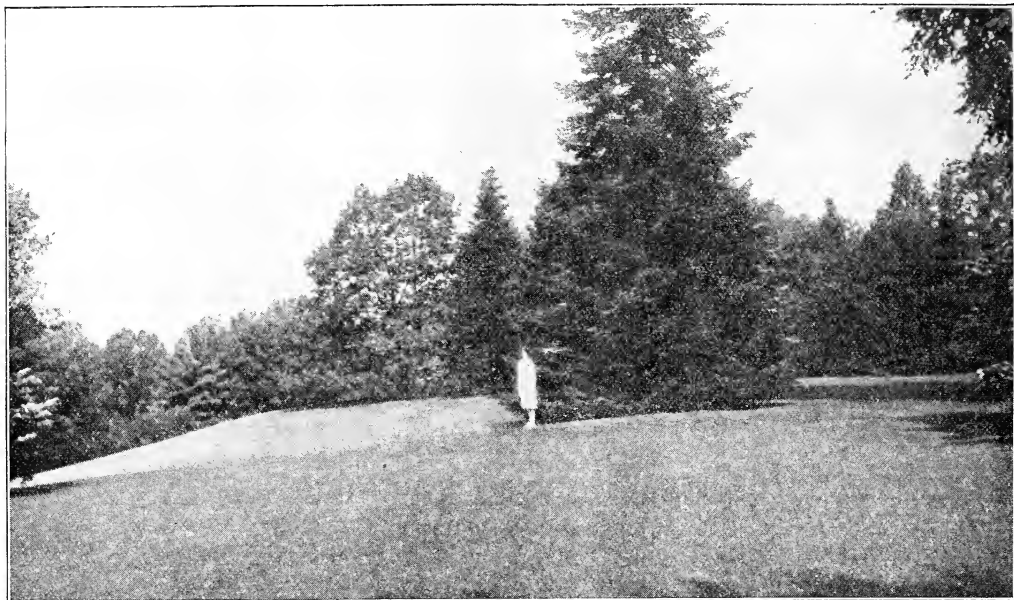

Part of Lawn at "Courtlands," Pomfret Centre, Conn.—George Farquhar, Superintendent

LAWNS

The following simple directions may be found useful to those who are not familiar with lawn making.

The soil should be of good depth, moderately rich, and in many cases the land should be carefully drained. Grading should be done and the soil thoroughly pulverized by careful harrowing and raking. Some good fertilizer—pure ground bone, wood ashes or a specially prepared lawn fertilizer—should be used. After spreading the fertilizer, the surface should be carefully raked and rolled. The rolling often develops uneven spots which should be leveled before the seed is sown. After sowing the ground should again be lightly raked and rolled.

The selection of seed is important. Use only such mixtures as are free from weed seeds, and such as will produce a firm, strong turf and a fine growth. A liberal quantity is necessary to secure good results (not less than 64 pounds per acre). The best time to make a lawn is from the middle of August through September. If seed is sown at this season, the grass will become strong enough to withstand the Winter, and a good lawn is assured the following season. If seed cannot be sown at this time, it should be sown as early as possible in the Spring.

Boston Lawn Grass Seed. This mixture is composed of such varieties as long experience has shown to be adapted to produce a permanent heavy turf. Weight 16 lbs. per bu. Per lb. 45c., 100 lbs. \$40.00.

Grey's Special Recleaned Lawn Grass Seed. Recleaned seeds only are used in this mixture, and it is as free from weed seeds and chaff as the latest improved seed-cleaning machinery can make it, and it is composed of such varieties as make a close and lasting turf. In recommending this grade to our customers we are sure we are recommending a mixture which cannot be excelled for general lawn purposes. Weight 32 lbs. per bu. Sow 64 lbs. per acre. Per lb. 65c., 100 lbs. \$60.00.

Mixture for Shaded Lawns. Fine grasses selected especially for locations partially shaded by buildings or trees. Weight 24 lbs. per bu. Lb. 70c., 100 lbs. \$65.00.

SPECIAL MIXTURES FOR TENNIS COURTS, GOLF LINKS, ETC.

The following mixtures used on many prominent golf courses, etc., in this vicinity, have given entire satisfaction.

Fair Green Mixture. For general use on golf links. Per lb. 85c., 100 lbs. \$75.00.

Putting Green Mixture. A combination of grasses best suited to produce a close, firm, and lasting turf, which will endure frequent cutting. Per lb. \$1.00, 100 lbs. \$90.00.

Tennis Court Mixture. A mixture of fine grasses especially adapted to tennis courts, which will bear trampling without injury. Lb. 90c., 100 lbs. \$80.00.

Ball Grounds Mixture. This mixture is used by both the Leagues in Boston with the most satisfactory results. Lb. 85c., 100 lbs. \$75.00.

Bowling Green Mixture. Mixture of fine, hardy grasses, especially adapted for bowling greens. Lb. \$1.00, 100 lbs. \$90.00.

CHOICE GRASS SEEDS

Many growers of grass seeds offer several grades of each variety, varying greatly in price. We do not recommend nor do we sell the inferior grades. Those which we offer are strictly **High grade**, and the prices at which we offer them should not be compared with those quoted for inferior grades.

Prices may change as the season advances. If to go by mail, add Parcel Post rates to cover postage.

Chewing's New Zealand Fescue. A splendid grass of creeping habit, forming a close and lasting turf; is a great drought resister, and thrives well on light, sandy soils. An excellent grass for golf courses. Lb. 65c., 100 lbs. \$60.00.

Creeping Bent (*Agrostis stolonifera*). One of the most valuable lawn grasses because of its short growth and deep green, fine-leaved foliage. Its stoloniferous roots form a strong, close, enduring turf, which is not injured by being frequently walked on. Per lb. \$1.50.

Crested Dogtail (*Cynosurus cristatus*). Good for permanent pasture for sheep; is productive and early, suffers but little from dry weather 35 lbs. to the acre. Lb. 85c., 100 lbs. \$80.00.

Hard Fescue (*Festuca duriuscula*). Admirable pasture grass of fine quality; thrives well in dry situations; 30 lbs. to the acre. Lb. 50c., 100 lbs. \$45.00.

Italian Rye Grass (*Lolium italicum*). Thrives in any soil, yields an early and abundant crop, valuable for mixing with other pasture grasses; sow 50 lbs. per acre. Lb. 30c., 100 lbs. \$25.00.

Kentucky Blue (*Poa pratensis*). Also called "June Grass;" an early grass of much value; will do well upon any ordinary soil; stands the heat of Summer remarkably well. For pastures and lawns it has no superior, giving that peculiar, rich shade of bluish green so much admired in the best lawns; also making a very close, velvety turf. It is usually sown mixed with other fine grasses; when used alone, 30 to 40 lbs per acre. Fancy clean seed. Lb. 60c., 100 lbs. \$55.00.

Meadow Fescue (*Festuca pratensis*). This is excellent for hay when sown with other grasses, such as Orchard grass and Timothy, and is also considered one of the best grasses for permanent pasture on a great variety of soils; sow 40 lbs. per acre. Lb. 40c., 100 lbs. \$35.00.

Meadow Foxtail (*Alopecurus pratensis*). One of the best and earliest of pasture grasses; thrives best in moist localities; 30 lbs. to the acre. Lb. \$1.00.

Orchard (*Dactylis glomerata*). One of the earliest grasses; yields immense crops and is excellent for pasture or hay; should be cut as it is coming into bloom, and will produce a heavy second crop; one of the best grasses. Sow 40 lbs. per acre. Lb. 35c., 100 lbs. \$32.00.

Perennial Rye Grass (*Ibodium perenne*). A valuable grass for pastures or meadows; also very valuable where mixed with other grasses for lawns, golf links, etc. The seed is large and heavy, and produces a good growth in five or six weeks. It is also well suited to a variety of soils, and makes excellent hay when grown with Red Clover. We offer an extra choice lot of seed. Lb. 30c., 100 lbs. \$25.00.

Prince Edward Isle Bent. Produces an ideal turf for Greens, Fairways, Bowling Greens and Fine Lawns. Grows anywhere Bents are adapted, but is especially suited to the acid soils of the New England and Eastern States. Lb. \$1.75.

Red Top (*Agrostis vulgaris*). A valuable native permanent grass, growing in almost any soil, moist or dry, but pays well for high cultivation; 10 to 12 lbs. per bus. Sow 40 lbs. per acre, if alone. Lb. 30c., 100 lbs. \$25.00.

Red Top Fancy. Absolutely clean and free from chaff. 36 lbs. per bus. Lb. 40c., 100 lbs. \$36.00.



Orchard Grass (*Dactylis glomerata*)

Red, or Creeping Fescue (*Festuca rubra*). A creeping rooted grass forming a close and lasting turf. Is especially adapted to dry and sandy soils, resists extreme drought, and is useful for gravelly banks and exposed hillsides. It is also valuable for shaded locations. Lb. 65c., 100 lbs. \$60.00.

Rhode Island Bent (*Agrostis canina*). Resembles Red Top, but is of dwarfer habit. A fine, hardy, very compact grass; very permanent, readily forming a heavy sward; excellent for lawns. Sow 4 bus. per acre, if alone. 14 lbs. per bus. Lb. \$1.75.

Rough Stalked Meadow Grass (*Poa trivialis*). A thickly matted, spreading rooted species, forming a firm, fine turf, especially adapted to the shaded parts of lawns. It thrives on moist, rich soils and in sheltered situations. Valuable for permanent pastures. Lb. 85c.

Sheep Fescue (*Festuca ovina*). In grass mixtures for high or dry land, this is especially valuable as it thrives on poor, light or gravelly soils. It is very hardy, resisting heat and cold. 16 lbs. per bus. Lb. 45c., 100 lbs. \$40.00.

Slender Fescue (*Festuca tenuifolia*). A variety of Sheep Fescue, but with finer leaves. It will grow on dry, poor soils and is useful in mixtures for dry banks and slopes. Lb. \$1.00.

CHOICE GRASS SEEDS—Continued

Sweet Vernal, True Perennial (*Anthoxanthum odoratum*). Useful to mix with other grasses for lawns, in which it is invaluable on account of its early growth and the fragrant odor which it imparts when drying. Lb. \$1.50.

Tall Fescue (*Festuca elatior*). Succeeds best on moist, alluvial and strong, clayey soils. Is especially valuable for permanent pastures. Stock of all kinds are fond of it, and it is rich in nutritive value. Lb. 60c.

Tall Meadow Oat Grass (*Avena elatior*). This grass produces an abundant supply of foliage, and is valuable for pasture on account of its early and luxuriant growth. It shoots up very quickly after being cut, and produces a thick growth of aftermath, which also makes it valuable as a soiling crop. Lb. 55c.

Timothy, "Herd's Grass." (*Phleum pratense*). One of the most valuable grasses and more generally used for hay than any other. It prefers a moist, loamy soil, not doing well on light soil. It is generally sown with Red Top and Red Clover, and makes the most valuable hay. 45 lbs. per bu. Present price, lb. 12c., 100 lbs. \$10.00.

Variety-leaved Fescue (*Festuca heterophylla*). Very early, hardy perennial, thriving best in cool, moist soils. Valuable in grass mixtures for permanent meadows. It is also useful in shady locations. 15 lbs. per bu. Lb. 70c., 100 lbs. \$65.00.

Wood Meadow (*Poa nemoralis*). A variety specially suited for the shaded portions of lawns, where other grasses do not grow. Very permanent and hardy, resisting extremes of heat and cold. The creeping roots make a strong, firm sod. Lb. 85c.

Special Mixtures for Permanent Hay

Sow 50 pounds to acre.

No. 1 for Cool, Moist Soils.....	50 lbs.	\$18.00
No. 2 for High, Dry Soils.....	50 lbs.	19.00
No. 3 for Wet Soils.....	50 lbs.	21.00

Special Mixtures for Permanent Pastures

Sow 50 pounds to acre.

No. 4 for Cool, Moist Soils.....	50 lbs.	\$23.00
No. 5 for High, Dry Soils.....	50 lbs.	24.00
No. 6 for Wet Soils.....	50 lbs.	24.00

MISCELLANEOUS SEEDS

Prices subject to change with the market

Beans, Soja. A valuable fodder crop, fed green or as ensilage. **Early Green**, bu. \$7.00. **Yellow Southern**, bu. \$5.00.

Cow Peas. These are grown extensively in warm countries. Sheep are very fond of them, but their chief value is as a green crop to plow under. 1½ bu. per acre.

New Era. One of the best varieties for northern planting, maturing early and being productive. Pk. \$2.00, Bu. \$7.00.

Clay. Prolific in yield of peas and vine. Pk. \$2.00, bu. \$7.00.

Black. Very prolific. Pk. \$2.00, bu. \$7.00.

Whippoorwill. Early. Pk. \$2.00, bu. \$7.00.

Kafir Corn. White; excellent for fodder, and the seed is valuable for pigeons. Lb. 15c., 100 lbs. \$12.00.

Peas, Canada Field. Valuable when sown with Oats as a green fodder. Also makes good ensilage. Sow 2 bu. Oats and 1 bu. Peas per acre. Bu. \$5.00.

Sunflower, Mammoth Russian. Used for feeding poultry. Lb. 18c., 100 lbs. \$15.00.

Rape, Dwarf Essex. True English Grown. Excellent for sheep pastures, also for soiling. If sown in May, pasturing can be had in August. Sow 10 lbs. per acre broadcast. Lb. 25c., 100 lbs. \$22.00.

Vetches, or Tares, Spring (*Vicia sativa*). Pea-like plant grown to some extent for feeding to stock. Frequently sown with Oats. Sow 1 to 1½ bu. per acre. Bu. \$8.00.

Vetches, Sand, Winter, or Hairy (*Vicia villosa*). Thrives on poor, arid, sandy soil, and can be sown either in Spring or Fall. Sow 40 to 50 lbs. per acre. Bu. of 60 lbs. \$15.00.

SUDAN GRASS

A quick-growing hay and pasture crop. Prepare the soil as for Corn; do not plant the seed until the soil becomes warm. Sown broadcast; use 16 to 24 lbs. of seed per acre. If planted in drills 18 to 24 in. apart from 4 to 6 lbs. Per lb. 15c., 100 lbs. \$13.00.

CLOVER SEEDS

Prices subject to change with the market.

Alfalfa, or Lucerne (*Medicago sativa*). Seed can be sown in April and May in this latitude, and much later in the South. 20 to 25 lbs. of seed per acre are required. Lb. 45c., 100 lbs. \$40.00.

Alfalfa, Genuine Grimm. It originated in northern Minnesota. The strong branching roots of Genuine Grimm Alfalfa prevent winterkilling. Sow 15 to 20 lbs. per acre. Lb. \$1.00.

Alsike, or Swedish (*Trifolium hybridum*). Hardest of all the Clovers and on rich, moist soil yields an enormous quantity of hay or pasturage. Valuable for sowing with Clovers or Grasses, as it forms a thick bottom and increases yield of hay. Lb. 40c., 100 lbs. \$35.00.

Bokhara Clover (*Mellilotus alba*). Valuable sort for soiling and for ensilage and bees. Lb. 25c., 100 lbs. \$20.00.

Add Parcel Post rates if wanted by mail.

Crimson Clover (*Trifolium incarnatum*). An annual variety, largely used in the South for feeding green and for hay. The yield in fodder is large, and after cutting, it at once commences growing again and continues until cut by frost. Sow in April or May; 20 lbs. to the acre. Not always hardy in New England. Lb. 30c., 100 lbs. \$25.00.

Red Clover, Medium (*Trifolium pratense*). The leading variety of Clover for pastures or meadows. Requires deep, rich soil. Sow in Spring. Lb. 60c., 100 lbs. \$55.00.

Red Northern, or Mammoth. Grows 4 to 5 feet high and is used to plow under for manure. Lb. 60c., 100 lbs. \$55.00.

White Dutch Clover (*Trifolium repens*). The best variety for lawns, as it forms a close herbage and remains green throughout the season; valuable when mixed with grass seeds for pasture. Lb. 90c.



Grey's Superior Quality Flower Seeds

Very carefully revised list to which many meritorious and recently introduced sorts have been added and all inferior varieties discarded.

All flower seeds mailed free on receipt of price quoted.

☛ If the number is used when ordering, it will not be necessary to write the name.

No.		Pkt.	No.		Pkt.
10	ABUTILON, Frize Mixed (Flowering Maple). Perpetual bloomers and rapid growers; seed sown indoors in March will produce plants that will bloom outdoors during the Summer and indoors all Winter.....	\$0.25		ACONITUM (Monkshood). Hardy perennials, with long spikes of hood-shaped flowers, excellent for shrubby borders and shady places. June to Sept.	
	ACACIA. Beautiful half-hardy shrubs, with pretty, ornamental foliage and graceful racemes of yellow flowers. Soak the seed in warm water before sowing. 6 to 10 ft.		55	napellus. Large, deep blue. 3 ft. . ¼ oz. \$1.25	\$0.15
15	baileyana. Long sprays of bright yellow flowers; excellent for cutting.....	¼ oz. 50c. .25	60	napellus roseum. Pink.....	.25
20	floribunda. Deep yellow.....	¼ oz. 35c. .15	65	pyrenaicum. Large yellow. 2½ ft.....	¼ oz. \$1.25 .15
25	lophantha superba. Fine yellow, delicate foliage.....	¼ oz. 35c. .15	68	wilsoni. Large trusses, light blue. 4 ft.....	.25
30	Finest Mixed Varieties. From a large collection.....	¼ oz. 35c. .15	70	Finest Mixed	¼ oz. 60c. .10
	ACANTHUS. Stately, ornamental, hardy perennials, remarkable for their beautiful foliage and curious flowers; in Aug. and Sept. 2 to 4 ft.			ACROCLINTUM. One of the prettiest and best annual everlastings for cutting fresh or for Winter use. For drying they should be cut before fully open and hung in an airy room to dry, heads down. 15 in.	
35	mollis. The beautiful foliage of this sort is said to have given rise to the Corinthian style of architecture; flowers white. ¼ oz. 35c.	.15	75	Double Rose	¼ oz. 35c. .10
40	mollis latifolius. Handsome sort; more robust than the preceding.....	¼ oz. 35c. .15	80	Double White	¼ oz. 35c. .10
45	ACHILLEA, The Pearl. One of the best hardy perennials, covered with heads of pure white, double flowers from Spring till frost; fine for cutting. 1½ ft.....	1-16 oz. \$1.50 .25	82	Single Rose	¼ oz. 35c. .10
50	ACHIMENES, Superb Mixed. Profuse blooming greenhouse plants, 1 ft. high, easily grown and flowering through the Summer. The flowers vary in size and are of the richest colors.....	.50	83	Single White	¼ oz. 35c. .10
			84	Mixed	¼ oz. 35c. .10
			90	ADLUMIA cirrhosa (Mountain Fringe, or Allegheny Vine). Beautiful climber, Maiden-hair fern-like foliage, pink flowers, a self-sowing, hardy biennial. 15 ft. 1-16 oz. 75c.	.15
				ADONIS. Free-flowering border plants, with showy flowers of easy culture in any garden soil.	
			95	aestivalis (Flos Adonis). Deep crimson, free-flowering annual. 1 ft. July and Aug.....	¼ oz. 25c. .10
			100	vernalis. Large, yellow flowers in May and June. Hardy perennial. 1 ft. ¼ oz. 75c.	.10
			105	AGATHEA coelestis (Blue Marguerite). Free-blooming, tender perennial, with blue Daisy-like flowers. Fine for Winter flowering, and a good bedder. 1½ ft.....	.15

- | No. | | Pkt. | No. | | Pkt. |
|-----|---|---|-----|---|-------------------------------|
| | AGERATUM. Effective plants for bedding, covered with bloom throughout the season. Valuable for cutting. Half-hardy annual. | | 240 | ANCHUSA capensis. Fine azure blue Forget-me-not-like flowers, excellent for cutting. 1 ft. | $\frac{1}{8}$ oz. 35c. \$0.10 |
| 110 | Blue Perfection. Deep blue. 1 ft. $\frac{1}{4}$ oz. 85c. | \$0.15 | 245 | italica, Dropmore Variety. Splendid, hardy perennial, with beautiful flowers of a lovely gentian blue; fine for borders or cutting. 4 ft. | $\frac{1}{4}$ oz. 85c. .25 |
| 115 | Blue Star. Bright light blue. 5 in. | .25 | 250 | ANEMONE coronaria, St. Brigid. An improved strain of the hardy garden Anemone, with larger and more brilliant flowers which remain longer in bloom. 1 ft. | .15 |
| 120 | Imperial Dwarf. Dark blue. 8 in. $\frac{1}{4}$ oz. 85c. | .15 | 253 | ANTHEMIS arabica. Annual yellow. | .10 |
| 125 | Imperial Dwarf. White. 8 in. | $\frac{1}{4}$ oz. 65c. .15 | 255 | kelwayi (Hardy Marguerite). A most satisfactory, hardy perennial, bearing throughout the Summer golden yellow, Daisy-like flowers, excellent for cutting. 2 ft. | $\frac{1}{8}$ oz. 50c. .10 |
| 130 | lasseauxi. Fine rose. 1 $\frac{1}{2}$ ft. | $\frac{1}{4}$ oz. 50c. .10 | | ANTHERICUM. One of the finest ornamental garden plants, producing freely fine spikes of sweet-scented lily-like flowers from May to July. Hardy perennial. 1 $\frac{1}{2}$ ft. | |
| 135 | Little Dorrit. Azure blue. 8 in. | $\frac{1}{4}$ oz. 50c. .10 | 265 | liliastrum Giant (St. Bruno's Lily). Large white, with green spots. | $\frac{1}{8}$ oz. \$1.00 .25 |
| 140 | mexicanum. Large, lilac blue. 1 $\frac{1}{2}$ ft. | $\frac{1}{4}$ oz. 40c. .15 | | ANTIRRHINUM. One of the most beautiful and useful bedding plants, blooming profusely and continuously throughout the Summer and Autumn. Our seeds of these are grown by specialists and are noted for the superior size and quality of their flowers. | |
| 145 | mexicanum album grandiflorum. Large white. 1 $\frac{1}{2}$ ft. | $\frac{1}{4}$ oz. 40c. .15 | | TALL VARIETIES, 2 to 2 $\frac{1}{2}$ ft. | |
| 150 | Princess Victoria Louise. Large white, white center. 8 in. | $\frac{1}{4}$ oz. 60c. .15 | 269 | Copper King, Maximum Type. | .25 |
| 155 | AGROSTEMMA coronaria, Mixed (Mullein Pink). Free flowering, hardy perennial, with bright crimson and white flowers; fine for cutting. 2 ft. | $\frac{1}{4}$ oz. 50c. .10 | 270 | Giant Mixed. Finest sorts. | $\frac{1}{4}$ oz. 60c. .10 |
| 160 | hybrida walkeri. Large, bright rose; hardy perennial. | .15 | 272 | Orange Beauty. | $\frac{1}{4}$ oz. \$1.00 .35 |
| 165 | coelirosa, Mixed (Rose of Heaven). Fine annual sort, with pink and white flowers; fine for cutting. 1 $\frac{1}{2}$ ft. | $\frac{1}{4}$ oz. 25c. .10 | 274 | Peachblow. Unique in color. | .25 |
| 170 | ALONSOA, Mixed (Maskflower). Charming annual, flowering throughout the Summer and Autumn; easily grown and very desirable. 1 $\frac{1}{2}$ ft. | $\frac{1}{8}$ oz. 30c. .15 | 275 | Giant Rose. | $\frac{1}{4}$ oz. 85c. .15 |
| 175 | ALSTROEMERIA, Finest Mixed. Handsome Lily-like, hardy perennials, varying from pale yellow to orange red; fine for cutting. Needs light protection in Winter. 3 ft. | $\frac{1}{4}$ oz. 75c. .25 | 280 | Giant Deep Crimson. | $\frac{1}{4}$ oz. 75c. .15 |
| | ALYSSUM. Dwarf-growing annuals, blooming profusely throughout the season. | | 285 | Giant Scarlet. | $\frac{1}{4}$ oz. 75c. .15 |
| 180 | benthani (Sweet Alyssum). White, fragrant, free bloomer. 1 ft. 4 oz. \$1.50, oz. 50c. | .10 | 290 | Giant Striped (Dobbies). | $\frac{1}{4}$ oz. 60c. .10 |
| 185 | Carpet of Snow (White Fleece). Pure white, very dwarf and sweet. 4 in. | $\frac{1}{4}$ oz. 40c., oz. \$1.25 .15 | 292 | Torchlight. Orange, yellow lip. | $\frac{1}{4}$ oz. 85c. .20 |
| 187 | Lilac Queen. Annual. Pure lilac color. Dwarf. | $\frac{1}{4}$ oz. 35c. .10 | 300 | Giant White. 2 $\frac{1}{2}$ ft. | $\frac{1}{4}$ oz. 85c. .15 |
| 190 | Little Dorrit. A perfect gem for borders or beds, compact, white and sweet. | $\frac{1}{4}$ oz. 40c. .15 | 305 | Giant Yellow. 2 $\frac{1}{2}$ ft. | $\frac{1}{4}$ oz. 85c. .15 |
| 195 | Little Gem. White, distinct and very sweet. | $\frac{1}{2}$ ft. | 315 | Cottage Maid. Pink, white throat. | $\frac{1}{4}$ oz. 50c. .10 |
| 200 | saxatile compactum (Gold Dust). Bright, yellow, Spring flowering, hardy perennial, 9 in. | $\frac{1}{4}$ oz. 85c., oz. \$3.00 \$0.15 | 325 | Fairy Queen. Rich orange salmon. | $\frac{1}{4}$ oz. 65c. .10 |
| 201 | saxatile Lemon Queen. Pale yellow. | $\frac{1}{8}$ oz. 75c. .15 | | | |
| | AMARANTHUS. Brilliant foliaged annuals, with showy racemes of flowers; very ornamental and excellent for borders and sub-tropical gardening. | | | | |
| 205 | caudatus (Love-lies-bleeding). Long drooping, scarlet racemes. 3 ft. | $\frac{1}{4}$ oz. 25c. .10 | | | |
| 210 | cruentus (Princesfeather). Dark red, feathery spikes of flowers. 3 ft. | $\frac{1}{4}$ oz. 25c. .10 | | | |
| 215 | salicifolius (Fountain Plant). Long foliage, beautifully variegated. 3 ft. | $\frac{1}{4}$ oz. 35c. .10 | | | |
| 220 | tricolor splendens (Josephs-coat). Foliage crimson, yellow and bronze. 2 ft. | $\frac{1}{4}$ oz. 50c. .15 | | | |
| 225 | AMARYLLIS, Special Hybrids (Hippeastrum). Saved from the finest, extra large flowering varieties. | .50 | | | |
| 230 | AMBROSIA mexicana. Sweet-scented annual. Useful in bouquets. 1 to 1 $\frac{1}{2}$ ft. | $\frac{1}{4}$ oz. 40c. .10 | | | |
| 235 | AMPELOPSIS veitchi (Boston Ivy). Popular, rapid growing, hardy vine. It adheres firmly to stone, brick or wood, foliage turning very brilliant in the Autumn. | $\frac{1}{4}$ oz. 35c. .10 | | | |

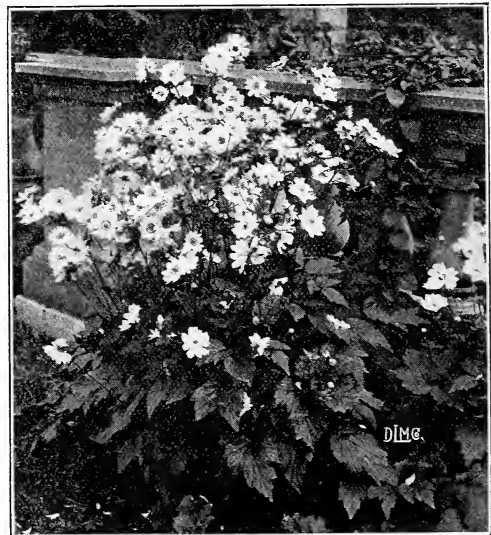

Anemone

No.	ANTIRRHINUM—Continued	Pkt.
TALL VARIETIES—Continued		
326	Feltham Beauty. Deep rose pink with white center; immense blooms.	$\frac{1}{8}$ oz. 75c. \$0.15
327	Nelrose.	$\frac{1}{4}$ oz. 60c. .15
330	Rose Dore. Salmon rose, shaded gold.	$\frac{1}{4}$ oz. 85c. .15
332	Silver Pink.	$\frac{1}{4}$ oz. 75c. .15
335	Collection of Six Varieties. Our selection.70
SEMI-DWARF VARIETIES, 15 to 18 in.		
340.	Art Shade. Ranging through pink, orange and terra cotta. 1 ft.	$\frac{1}{4}$ oz. 75c. .15
345	Amber Queen. Canary yellow, overlaid with chamouis pink, golden lip.	$\frac{1}{4}$ oz. 75c. .15
347	Beacon. Beautiful salmon-rose with deeper gold-tipped center.20
350	Carmine Queen. Rose carmine.	$\frac{1}{4}$ oz. 75c. .15
355	Cottage Maid. Pale coral pink, white throat.	$\frac{1}{4}$ oz. 60c. .10
360	Crimson King. Bright crimson.	$\frac{1}{4}$ oz. 75c. .15
365	Golden Queen. Pure yellow.	$\frac{1}{4}$ oz. \$1.00 .15
371	Pink Queen. Lovely pink, yellow lip, spikes.	$\frac{1}{8}$ oz. 75c. .15
375	Queen of the North. Pure white.	$\frac{1}{4}$ oz. 85c. .15
380	Mixed. Finest varieties.	$\frac{1}{4}$ oz. 50c. .10
355	Collection of Six Varieties. Our selection.70
TOM THUMB VARIETIES, 8 to 10 in.		
Excellent for bedding, blooming all Summer. Height about 10 in.		
330	Antique Rose.	$\frac{1}{8}$ oz. 85c. .15
395	Brilliant Crimson.	$\frac{1}{8}$ oz. 85c. .15
400	Bronze and Gold.	$\frac{1}{8}$ oz. 85c. .15
405	Canary Yellow.	$\frac{1}{8}$ oz. 85c. .15
410	Dark Scarlet.	$\frac{1}{8}$ oz. 85c. .15
415	Snowflake. Extra pure white.	$\frac{1}{8}$ oz. 85c. .15
420	Choice Mixed.	$\frac{1}{8}$ oz. 85c. .15
425	Collection of Six Varieties. Our selection.70
AQUILEGIA (Columbine). Beautiful, free-flowering, hardy perennials, blooming profusely through the Spring and early Summer and of easiest cultivation. Early sown seed will bloom the same season. 1½ to 3 ft.		
430	Grey's Columbia Hybrids. Special long-spurred strain. The colors include the most charming combinations from the brightest to the most delicate tints.	$\frac{1}{8}$ oz. \$1.50, $\frac{1}{4}$ oz. \$2.50 .50
435	canadensis. Scarlet and yellow native species.	$\frac{1}{4}$ oz. \$1.25 .15
440	chrysantha. Showy, bright yellow.	$\frac{1}{4}$ oz. \$1.75 .15
445	chrysantha grandiflora alba. Large, pure white.	$\frac{1}{4}$ oz. \$2.00 .25
450	coerulea (Rocky Mountain Columbine). Splendid, large, light blue.	$\frac{1}{4}$ oz. \$2.50 .25
455	coerulea alba. White, long spurs.	$\frac{1}{4}$ oz. \$2.25 .25
460	coerulea rosea. Rose, long spurs.	$\frac{1}{4}$ oz. \$4.00 .25
465	glandulosa. Deep blue, with white center.25
466	Long-spurred Pink Shades.25
477	Mrs. Scott Elliott's Strain.	$\frac{1}{8}$ oz. \$1.25 .50
475	olympica. Large, delicate mauve.	$\frac{1}{4}$ oz. \$1.00 .15
487	skinneri. Scarlet and yellow.	$\frac{1}{4}$ oz. \$1.50 .25
485	Mixed Single Varieties.	$\frac{1}{4}$ oz. \$1.00 .10
490	Mixed Double Varieties.	$\frac{1}{4}$ oz. \$1.50 .25
495	Collection of Six Varieties. Our selection.	1.00
500	ARABIS alpina. Hardy perennial, with pure white flowers, blooming early in the Spring; valuable for edgings and rockwork; will grow well in rather shaded position.	$\frac{1}{4}$ oz. 50c. .10
505	grandiflora superba. Improved, large flowers.	$\frac{1}{4}$ oz. \$1.25 .15
510	ARALIA sieboldi. A most desirable foliage plant, well suited for the conservatory and for plunging in flower beds during Summer. 2 to 3 ft.25

No.		Pkt.
515	ARCTOTIS grandis. Handsome annual from South Africa, with large, daisy-like flowers, white, with light blue center, the underside of petals being pale blue. 2 ft.	$\frac{1}{4}$ oz. 75c. \$0.15
520	ARGEMONE grandiflora. Large, pure white poppy-like flowers; showy. 2 ft.	$\frac{1}{4}$ oz. 50c. .10
	ARMERIA (Thrift, or Sea Pink). Pretty hardy perennial for edgings, blooming all Summer; tufted flowers.	
525	formosa. Dark crimson. 1 ft.	$\frac{1}{4}$ oz. 60c. .10
535	ASCLEPIAS tuberosa. One of the most showy of our Summer and Autumn flowering, hardy perennials, with umbels of bright orange-colored flowers. 1½ ft.	$\frac{1}{4}$ oz. \$1.75 .15
540	ASPARAGUS plumosus nanus. Beautiful house plants; the feathery foliage is unrivaled for cutting.	100 seeds, \$1.25 .25
545	sprengeri. Excellent plant for table decoration or to grow in pots or baskets.	$\frac{1}{4}$ oz. 35c. .25
550	ASPERULA azurea setosa. Annual species of Woodruff, with fragrant, light blue flowers, blooming through the Summer and fine for cutting. It will grow in poor soil or in shaded places. 1 ft.	$\frac{1}{4}$ oz. 50c. .15
555	odorata (Sweet Woodruff). Hardy perennial, conspicuous in May by its pure white, sweet-scented flowers. The foliage and flowers when dried retain their fragrance. Grows well under trees.	$\frac{1}{4}$ oz. 85c. .15
560	tinctoria. Small, white flowered perennial; can be used for same purposes as Gypsophila.	$\frac{1}{4}$ oz. 75c. .15
	ASPHODELUS. Showy plants with handsome flower spikes. They grow well in any soil. Hardy perennial.	
570	luteus. Fine, yellow, fragrant. 3 ft.	$\frac{1}{4}$ oz. 75c. .15

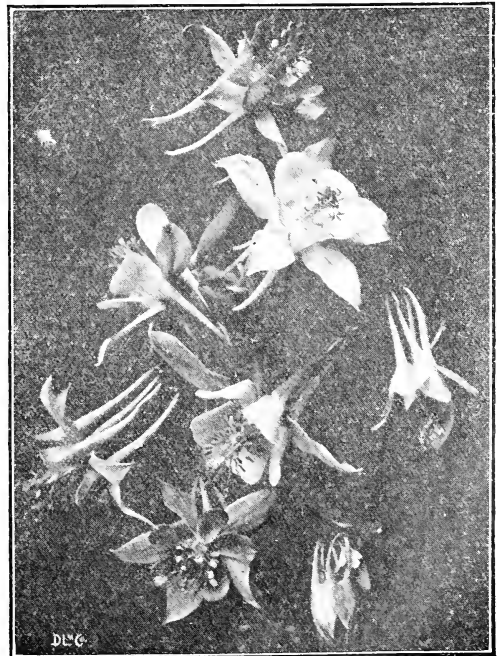

Grey's Columbia Hybrid Aquilegia

No.	ASTERS—Continued	Pkt.
	IMPERIAL, "Improved American Victoria." The best known and most extensively used of all the Summer-flowering varieties; distinguished by their delicacy of coloring, profusion of bloom and the extreme doubleness of their large flowers which are produced on long, strong stems. 2 ft.	
805	Blue Bird. Beautiful light blue.	1/8 oz. 85c. \$0.15
810	Daybreak. Delicate shell pink.	1/8 oz. 85c. .15
815	Lavender. Clear, delicate shade.	1/8 oz. 85c. .15
820	Rosy Morn. Bright rose.	1/8 oz. 85c. .15
825	Purity. Snow white.	1/8 oz. 85c. .15
830	Salmon King. Pinkish salmon.	1/8 oz. 85c. .15
835	Yellow. Lemon yellow, pink flush.	1/8 oz. 85c. .15
840	LAVENDER GEM. An early branching sort of the Comet type, with large, double, wavy petaled flowers of an exquisite shade of lavender. 2 ft.	1/8 oz. 75c. .15
	MIKADO. A superior strain of the Comet type. The flowers are large and full, with long, graceful, reflexed petals, the center ones curling across each other in magnificent disorder. They bloom at midseason and resemble the Branching Asters in vigor and immense bloom. 2 ft.	
845	Pink (Rochester). Lavender pink.	1/8 oz. 75c. .15
850	Purple. Deep, rich color.	1/8 oz. 75c. .15
855	Rose. Deep, brilliant rose.	1/8 oz. 75c. .15
860	White. Immense pure white.	1/8 oz. 75c. .15
	PEONY-FLOWERED PERFECTION. One of the best incurved varieties. Flowers large, full, and very double; blooms in Aug. 2 ft.	
865	Blood Red.	1/8 oz. 85c. .15
870	Dark Blue.	1/8 oz. 85c. .15
875	Light Blue.	1/8 oz. 85c. .15
880	Pink.	1/8 oz. 85c. .15
885	Snow White.	1/8 oz. 85c. .15
890	Mixed.	1/8 oz. 85c. .15
	QUEEN OF THE MARKET. The earliest flowering first-class aster. Coming into bloom 3 to 4 weeks earlier than other sorts. The flowers are of good size on long stems and extensively grown for cutting. 1 ft.	
895	Collection of the following 6 colors.50
900	Crimson.	1/4 oz. 75c., oz. \$2.00 .10
905	Dark Blue.	1/4 oz. 75c., oz. 2.00 .10
910	Flesh Pink.	1/4 oz. 75c., oz. 2.00 .10
915	Light Blue.	1/4 oz. 75c., oz. 2.00 .10
920	Rose.	1/4 oz. 75c., oz. 2.00 .10
925	White.	1/4 oz. 75c., oz. 2.00 .10
930.	Mixed. All colors.	1/4 oz. 75c., oz. 2.00 .10
935	SENSATION, New Red. Entirely different from all others, and in a class of its own. It is the reddest of all red asters, the color being a dark, rich garnet, which glistens in the sunshine. Flowers very double, 3 inches across, and borne freely on long stems. It blooms with the late sorts; branching habit. 1 1/2 ft.	1/4 oz. \$1.25 .15
940	SNOWDRIFT. One of the earliest and most valuable sorts, coming into bloom in July, with superb, large snow white flowers of the Hohenzollern type; very free. 2 ft.	1/4 oz. \$1.50 .15
	TRIUMPH COMET. A magnificent new class of midseason asters, with extra long stems and very large , full, double, fluffy flowers. The finest and largest of the Comet type ever offered. 2 1/2 ft.	
945	Lavender.	1/8 oz. 75c. .15
950	Purple.	1/8 oz. 75c. .15
955	Rose.	1/8 oz. 75c. .15
960	Shell Pink.	1/8 oz. 75c. .15
965	White.	1/8 oz. 75c. .15

No.		Pkt.
	SINGLE ASTER ELEGANCE. New, large-flowered, single sort, on long stems, with beautiful long petals. 1 1/2 ft.	
1020	Deep Rose.	1/8 oz. 75c. .10
1025	Deep Blue.	1/8 oz. 75c. .10
1028	General Joffre. Crimson scarlet.	1/8 oz. 75c. .15
1030	Lavender.	1/8 oz. 75c. .10
1035	Pink.	1/8 oz. 75c. .10
1040	White.	1/8 oz. 75c. .10
1045	Mixed.	1/8 oz. 75c. .10
	SINGLE GIANTS OF CALIFORNIA. A new type of single Aster, with flowers measuring 3 to 4 inches across with stems 1 1/2 to 2 ft. in length. The petals are slightly twisted. Fine for the garden or cut flowers.	
976	Delicate Flesh.	1/8 oz. 60c. .10
981	Light Blue.	1/8 oz. 60c. .10
986	Lilac.	1/8 oz. 60c. .10
991	Purple.	1/8 oz. 60c. .10
996	Rose.	1/8 oz. 60c. .10
1001	White.	1/8 oz. 60c. .10
1006	Finest Mixed.	1/8 oz. 60c. .10
	ASTER, Perennial Sorts (Michaelmas Daisies). We have in this class some of the most showy, beautiful and interesting hardy plants grown; their graceful habit, profusion of bloom and great variety of color form the chief attraction of the flower garden throughout the Autumn months.	
1050	alpinus speciosus. Large, rich purple.25
1055	subcaeruleus. A fine species, with very large, mauve-colored, orange-centered flowers, 2 to 3 inches across, borne on long stems. It begins blooming quite early. 2 ft.25
1060	White Queen. Large white.25
1065	Mixed Hybrids, New Large-flowered. This strain contains many beautiful colors, and the flowers, which are produced in great profusion, afford elegant sprays for cutting. 2 to 4 ft.	1/4 oz. \$1.75 .25



Queen of the Market

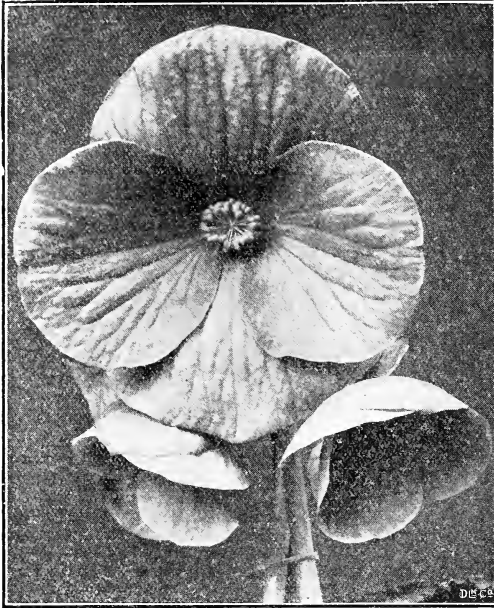

Single Begonia, Tuberous-rooted

No.		Pkt.
	AUBRIETIA. These dwarf, hardy perennials are invaluable for the border, rockeries, etc.; they are among the brightest and most free flowering plants of early Spring.	
1070	graeca. Beautiful purple color.....	\$0.25
1075	leichtlini. Rosy red, very pretty.....	.25
	AURICULA. See <i>Primula auricula</i> .	
	BACHELOR BUTTON. See <i>Centaurea</i> .	
	BALSAM. These old-fashioned annuals so easily grown are again increasing in popularity, and most beautiful and brilliant effects may be had from them; overcrowding should be avoided and they should be set at least 18 inches apart for best results.	
1080	Columbia Prize. An unsurpassed strain in doubleness, size, brilliancy and variety of color.....	¼ oz. \$1.00 .25
1085	Dark Blood Red. Extra.....	¼ oz. 60c. .10
1090	Intense Scarlet (The King)	¼ oz. 60c. .10
1095	Rich Pink (Salmon King)	¼ oz. 75c. .25
1100	White (Snowball). Superior.....	¼ oz. 75c. .25
1105	Mixed Rose-flowered. Very double.....	¼ oz. 40c. .10
1110	BALLOON VINE. A rapid growing annual climber, with white flowers and inflated seed vessels which look like miniature balloons.....	Oz. 40c. .10
1115	BAPTISIA australis (False Indigo). Handsome hardy perennial, producing bright blue, pea-shaped flowers on spikes 6 inches long. 2½ ft.....	¼ oz. \$1.00 .15
1120	BARTONIA aurea. Showy, hardy annual of distinct character, its large, golden yellow flowers being freely produced; succeeds well in partial shade. 1½ ft.....	¼ oz. 50c. .10

No.	BEANS, Flowering. Popular ornamental climbers, with edible pods of delicious flavor. 6 to 8 ft.	Pkt.
1125	Butterfly Runner. Large, pink and white. ¼ lb. 50c., lb. \$1.50	\$0.15
1130	Scarlet Runner. Large, brilliant scarlet. Lb. 45c.	.10
1135	White Runner. Large, pure white. Lb. 45c.	.10
	BEGONIA, Tuberous-rooted. These are easily grown from seed and may be had in bloom in about 6 months. They make a gorgeous display throughout the season and are excellent for bedding purposes, window boxes, etc., and as pot plants are effective for house and conservatory. 1 ft.	
1140	Double, Prize Mixed	1.00
1145	Single, Giant Mixed50
1150	Single Fringed. Unsurpassed strain.....	.50
	BEGONIA, Fibrous-rooted. The following sorts are perpetual bloomers and extensively used for planting outside in beds and for pot culture in the greenhouse. 1 ft.	
1155	gracilis alba. Pure white.....	.25
1160	Bonfire. Lustrous carmine, with brownish red foliage.....	.25
1165	Mignon. Brilliant salmon scarlet. New, 8 in.....	.25
1170	luminosa. Dark scarlet, reddish brown foliage.....	.25
1175	rosa. Fine rose pink.....	.25
1180	erfordi. Lovely rosy carmine flowers, with dark, glossy, green foliage. One of the best.....	.50
1185	Salmon Queen. Brilliant salmon red, passing to salmon rose; the dark green foliage has a reddish hue.....	.50
1190	Triumph. Beautiful, large, snow white flowers; excellent.....	.50
1195	Vernon. Deep scarlet, with bronze foliage.....	.25
1200	Vernon, Dwarf. Rich red, with glossy bronze foliage. 8 in.....	.25
1205	Rex Varieties, Mixed (Ornamental leaved). Large, handsomely variegated leaves.....	.75
	BELLIS perennis fl. pl. (Double Daisy). Favorite perennial producing in Spring their handsome, double flowers, and are very effective when planted with Pansies or Forget-me-nots. Rich soil and cool situation suit them best.	
1210	Longfellow. Large, dark rose... ¼ oz.	\$2.00 .15
1215	Snowball. Large, pure white... ¼ oz.	\$2.00 .15
1220	monstrosa Rose. Extra large... ½ oz.	\$1.50 .25
1225	monstrosa White. Extra large... ½ oz.	\$1.50 .25
1230	Quilled, Giant Red. Dark red.....	.25
1235	Quilled, Giant White. Pure white.....	.25
1240	Finest Mixed. Double..... ⅜ oz.	85c. .15
	BELVIDERE. See <i>Kochia</i> .	
1245	BOCCONIA japonica (Plume Poppy, or Tree Celandine). Ornamental, hardy perennial, with glaucous green foliage and spikes of creamy white flowers, 2 to 3 feet long; grown in clumps or as single specimens, they produce a marked effect. 5 ft.....	¼ oz. 50c. .10
1250	BOLTONIA latisquama. One of our showiest hardy perennials, with large clusters of lavender-pink, Daisy-like flowers. 5 ft.	.25
	BROWALLIA. Beautiful, profuse blooming bedding and pot plants. 1½ to 2 ft.	
1255	speciosa major. Large, brilliant, ultramarine blue; splendid Winter bloomer...	.25
1256	White, same habit as above.....	.50
1260	Mixed. Shades of blue and white. ¼ oz.	50c. .15

No		Pkt.
	BRUGMANSIA. See <i>Datura arborea</i> .	
1265	BUPHTHALMUM salicifolium (Ox-Eye). Fine, hardy perennial, with large, golden yellow flowers on long stems. 2 ft. $\frac{1}{4}$ oz. 60c. \$0.10	
	BRACHYCOME (Swan River Daisy). Pro- fuse flowering, low growing annual, with pretty Daisy-like flowers; doing best in warm and dry situations. 9 in.	
1270	Blue Star. Beautiful bright blue. $\frac{1}{8}$ oz. 50c. .15	
1275	rosea. Fine rose color. $\frac{1}{4}$ oz. 75c. .15	
1280	Mixed. Shades of blue, white and rose. $\frac{1}{4}$ oz. 40c. .10	
1285	CACALIA coccinea (Tassel Flower). A neat, free blooming annual, with scarlet tassel- like flowers. All Summer. $1\frac{1}{2}$ ft. $\frac{1}{4}$ oz. 35c. .10	
1290	CACTUS, Mixed Varieties. Succulent plants of curious and ornamental growth, with showy flowers. Tender perennials. .25	
	CALCEOLARIA. Our seeds are from noted English growers and saved from the finest strains grown, which have been awarded the leading prizes.	
1295	Covent Garden Strain. Extra choice, strongly recommended for habit, size and marking of flowers. .75	
1300	KELWAYS Perfect Model. Of splendid habit, neither too tall nor too dwarf; large heads of very large flowers, which are well rounded and filled out, the richest and most delicate colors in the most wonder- ful variety of shades and markings. .1.00	
1305	rugosa, or Shrubby, Mixed. Choice bed- ding varieties, with innumerable flowers. .50	
	CALENDULA officinalis fl. pl. (Pot Mari- gold). Valuable, hardy annual, the double showy flowers making a grand display for months; suitable for dry places. 1 ft.	
1318	Ball's Orange, light center. Oz. \$3.00 .15	
1319	Ball's Gold, deep golden. Oz. \$3.00 .15	
1310	Lemon Queen. Lemon yellow. Oz. \$1.00 .15	
1315	Meteor. Lemon, striped with orange. Oz. 50c. .10	
1320	Orange King. Large, dark orange. Oz. \$1.00 .15	
1330	Mixed. Shades of lemon and orange. Oz. 35c. .10	
	CALIFORNIA POPPY. See <i>Eschscholtzia</i> .	
	CALLIOPSIS, or COREOPSIS. Remark- able, showy, hardy annuals, very contin- uous in flowering, hardly anything surpass- ing them in this respect, and most useful for cutting. $1\frac{1}{2}$ to 2 ft.	
1335	coronata maxima. Large yellow. $\frac{1}{4}$ oz. 40c. .10	
1340	drummondii (Golden Wave). Golden yel- low, with brown center. $\frac{1}{4}$ oz. 40c. .10	
1345	Fire King. Deep, bright scarlet, cactus- shaped petals.15	
1351	Nana. "The Garnet" Dwarf; glossy crimson scarlet; 15 to 18 inches.20	
1355	Mixed. Fine varieties. $\frac{1}{4}$ oz. 25c., oz. 75c. .10	
1360	Mixed, Double (Hybrida fl. pl.) . $\frac{1}{4}$ oz. 35c. .10	
	CALLIOPSIS, or COREOPSIS. Hardy Per- ennial Varieties. Early sown seed will bloom the same season, but it is better to sow in July and protect lightly in Winter.	
1365	Eldorado. California strain, with very large, golden yellow flowers. . . $\frac{1}{4}$ oz. \$1.00 .25	
1370	grandiflora. Bright, golden yellow. $\frac{1}{4}$ oz. 50c. .10	
1375	lancelota. Large, bright yellow. $\frac{1}{4}$ oz. 60c. .15	
1380	CALLIRHOE involucrata (Poppy Mallow). Showy, hardy perennial of spreading growth, with large, bright crimson, saucer- shaped flowers from early Summer till Fall. 1 ft. $\frac{1}{4}$ oz. 60c. .15	

No.		Pkt.
	CAMPANULA (Bellflower). Beautiful, well- known, hardy perennial, and one of our most attractive garden flowers, noted for their rich colors and profusion of bloom.	
1385	carpatica. Erect blue flowers all Summer; useful for borders or rockery. 9 in. $\frac{1}{4}$ oz. \$1.00. \$0.15	
1390	carpatica alba. Erect, white flowers. 9 in. $\frac{1}{4}$ oz. \$1.00. .15	
1395	mirabilis. Large, pale blue; extra. 2 ft. .50	
1400	moerheimi. Large, white, saucer-shaped flowers. 2 ft. $\frac{1}{8}$ oz. \$1.50 .25	
1405	persicifolia grandiflora. Large, bright blue; one of the best. 2 ft. $\frac{1}{8}$ oz. \$1.25 .25	
1410	persicifolia grandiflora alba. Large, pure white. 2 ft. $\frac{1}{8}$ oz. \$1.25 .25	
1415	persicifolia grandiflora pfitzeri. Large, light blue, double and semi-double. 2 ft.25	
1420	persicifolia. Mixed. All shades of blue and white. 2 ft. $\frac{1}{8}$ oz. \$1.25 .25	
1425	pyramidalis (Chimney Bellflower). Blue, 4 ft. $\frac{1}{8}$ oz. 75c. .15	
1430	alba. White. 4 ft. $\frac{1}{8}$ oz. 75c. .15	
1433	compacta Mixed. Much more dwarf and free blooming than preceding.15	
	CAMPANULA medium (Canterbury Bells). Showy, hardy biennials, about 3 ft. high, of pyramidal form, and profusely covered with large bell-shaped flowers.	
	calcyanthema (Cup and Saucer Varieties).	
1440	Blue. $\frac{1}{4}$ oz. \$1.75 .15	
1445	Rose Pink. $\frac{1}{4}$ oz. 1.75 .15	
1450	White. $\frac{1}{4}$ oz. 1.75 .15	
1455	Mixed. All colors. $\frac{1}{4}$ oz. 1.75 .15	
1457	Double Mixed3'	
1460	Single, Blue. $\frac{1}{4}$ oz. 60c. .10	
1465	Rose Pink. $\frac{1}{4}$ oz. 60c. .10	
1470	Reddish Violet. $\frac{1}{4}$ oz. 60c. .10	
1475	Mauve. $\frac{1}{4}$ oz. 60c. .10	

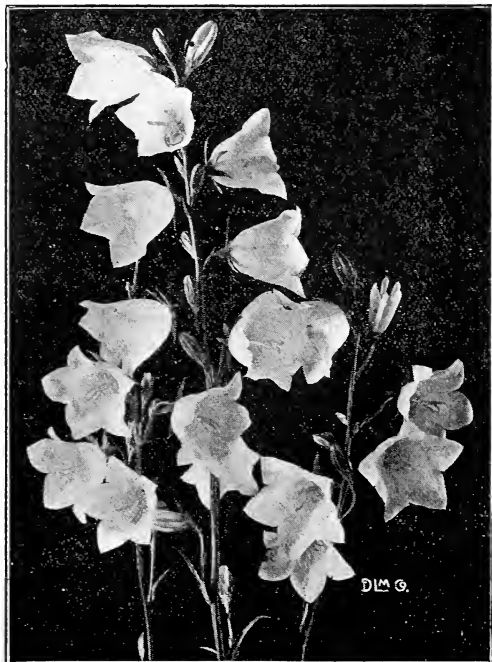

Campanula persicifolia

No.		Pkt.
CAMPANULA medium —Continued		
1480	Single White.....	¼ oz. 60c. \$0.10
1485	Mixed. All colors.....	¼ oz. 60c. .10
1490	Double, Blue.....	¼ oz. \$1.00 .15
1495	Rose Pink.....	¼ oz. 1.00 .15
1500	White.....	¼ oz. 1.00 .15
1505	Mixed. All colors.....	¼ oz. 1.00 .15
1510	Columbia Prize Mixture. All colors of all varieties, unsurpassed.....	¼ oz. \$1.00 .25

CANARY BIRD VINE. See **Tropaeolum.**

CANDYTUFT. One of the most useful and popular hardy annuals for edgings or massing, and excellent for cutting. 1 ft.

1515	Carmine. Carmine rose.....	¼ oz. 60c., oz. \$2.00 .15
1520	Crimson. Rich, deep shade.....	¼ oz. 25c., oz. 75c. .10
1525	Dobbies White Spiral. A superior strain of the large flowered white from the introducer.....	¼ oz. 50c., oz. \$1.50 .10
1530	Empress. Immense, pure white pyramidal trusses.....	¼ oz. 35c., oz. \$1.00 .10
1535	Giant Perfection. Immense pure white spikes. Special selection.....	¼ oz. 60c., oz. \$2.00 .15
1540	Purple. Fine shade.....	¼ oz. 20c., oz. 50c. .10
1541	Queen of Italy.	¼ oz. 50c. .10
1545	Mixed. All colors.....	¼ oz. 15c., oz. 40c. .10
1550	Dwarf Rose	¼ oz. 60c., oz. \$1.75 .15
1555	White	¼ oz. 60c., oz. 1.75 .15
1560	Mixed Hybrids.	¼ oz. 50c., oz. 1.50 .10

CANNAS. Handsome foliage and flowering plants, producing striking effects in beds or borders. Soak the seed in hot water 24 hours before sowing. 3 to 4 ft.

1565	Crozy's New Large-flowering Varieties. Newest and best sorts.....	Oz. 60c. .10
1570	Dark-leaved Sorts. Dark foliaged sorts with large flowers.....	Oz. 75c. .10

CARDINAL CLIMBER. See **Ipomoea Quamoclit.**

CARNATION PINKS. See **Dianthus.**
CASTOR OIL BEANS. See **Ricinus.**



Celosia childsi



Canna

No. Pkt.

CATCHFLY. See **Silene.**

CELOSIA cristata, or COCKSCOMB. Free blooming annuals; large, brilliant Cockscomb-like heads. They prefer a light soil not too rich; fine border or pot plant.

1575	Collection 6 following colors, separate.....	\$0.60
1580	Dwarf Bright Rose. ¾ ft.....	1/8 oz. \$1.00 .15
1585	Copper Color. ¾ ft.....	1/8 oz. 1.00 .15
1590	Dark Blood Red. ¾ ft.....	1/8 oz. 1.00 .15
1595	Glasgow Prize. Dark crimson. ¾ ft. 1/8 oz. 1.25 .15	
1600	Golden Yellow. ¾ ft.....	1/8 oz. 1.00 .10
1605	Silvery White. ¾ ft.....	1/8 oz. 1.00 .10
1610	Mixed. Finest colors. ¾ ft.....	1/8 oz. .75 .10
1615	Tall Mixed. All colors. 2 to 3 ft.....	1/8 oz. .20 .10

CELOSIA thompsoni magnifica, Improved Feathered Cockscomb. A magnificent and valuable annual, with long, feathery plumes of the richest colors, varying from pale yellow to the deepest crimson. Effective during Summer and Fall. 2 ft.

1617	childsi (Chinese Woolflower).....	.15
1620	Carmine.....	1/8 oz. 50c. .15
1625	Crimson.....	1/8 oz. 50c. .15
1630	Golden Yellow.....	1/8 oz. 50c. .15
1635	Light Yellow.....	1/8 oz. 50c. .15
1640	Scarlet.....	1/8 oz. 50c. .15
1645	Triumph of Exposition. Crimson, dark red stems.....	1/8 oz. 50c. .15
1650	Mixed. All colors.....	1/8 oz. 50c. .15

CELSIA arcturus. A fine half hardy plant, very pretty for pot culture in a cool house. The long spikes of bright yellow flowers are produced the same season from Spring sown seed.....

CENTAUREA (Dusty Miller). Silver foliaged plants, extensively used for edgings, baskets, etc. Half-hardy perennial.

1665	candidissima. Thick foliage. 1 ft.....	1/8 oz. 50c. .15
1670	gymnocarpa. Very graceful. 1 1/2 ft.....	1/4 oz. 50c. .15

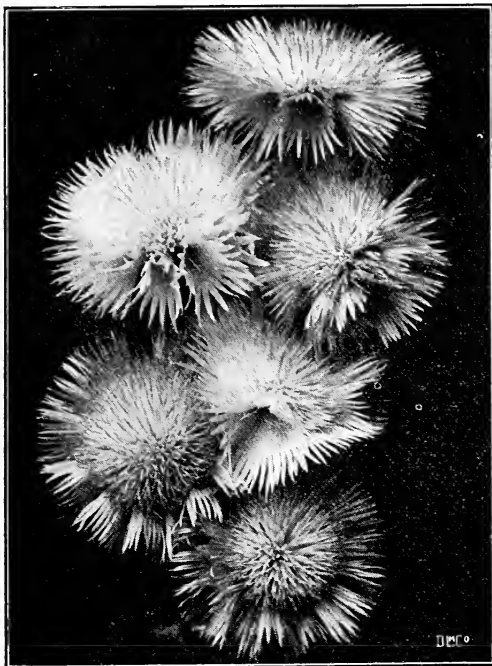

Centaurea imperialis

No. Pkt.

CENTAUREA, Annual Varieties. Very free flowering, hardy annuals, with handsome, showy flowers; extremely useful for cutting. 1½ to 2 ft.

- 1675 **americana.** Large, reddish lilac. ¼ oz. 60c. \$0.15
- 1680 **cyanus, Mixed** (Bachelor Button). Oz. 60c. .10
- 1685 **Double, Mixed**..... Oz. \$1.00 .10
- 1690 **Blue**..... Oz. 60c. .10
- 1695 **Double Blue**..... ¼ oz. 60c. .15
- 1700 **Purple**..... Oz. 60c. .10
- 1705 **Rose**..... Oz. 60c. .10
- 1710 **White**..... Oz. 60c. .10

imperialis (Royal Sweet Sultan). Very large, sweet scented flowers, on long stems, in the most beautiful and delicate colors. 2 to 3 ft.

- 1715 **Bright Pink**..... ¼ oz. 75c. .15
- 1720 **Dark Purple**..... ¼ oz. 75c. .15
- 1725 **Deep Lavender**..... ¼ oz. 75c. .15
- 1730 **Lilac**..... ¼ oz. 75c. .15
- 1735 **White**..... ¼ oz. 75c. .15
- 1740 **Mixed.** All colors..... ¼ oz. 75c. .15
- 1745 **moschata** (Sweet Sultan). Purple. ¼ oz. 20c. .10
- 1755 **White**..... ¼ oz. 20c. .10
- 1760 **Mixed**..... ¼ oz. 20c. .10
- 1765 **suaveolens.** Yellow Sweet Sultan ¼ oz. 60c. .15

CENTAUREA, Perennial Varieties. Desirable, hardy plants, with showy thistle-like flowers from July to September.

- 1770 **macrocephala.** Large yellow. 3 ft.15
- 1775 **montana.** Deep purple. 2 ft. ¼ oz. 75c. .15
- 1780 **alba.** Large white. 2 ft. ¼ oz. 75c. .15
- 1785 **rosea.** Rose pink. 2 ft.25

- 1790 **CERASTIUM tomentosum** (Snow-in-summer). A white foliaged hardy perennial, with small, white flowers; fine for edgings and rockeries. 4 in. ¼ oz. 75c. .25

No. Pkt.

- 1792 **CHEIRANTHUS allioni** (Alpine Wallflower). Excellent dwarf perennial for rocky or margin of herbaceous border, brilliant orange flowers in Spring and all Summer if seed pods are removed. ¼ oz. \$1.00 \$0.25

CHELONE. Very handsome plant, with Pentstemon-like spikes of brilliant colored flowers from July to October. Hardy perennial. 2 ft.

- 1795 **barbata torreyi.** Scarlet. ¼ oz. 75c. .15
- 1800 **Hybrid, Finest Mixed.** Beautiful. ¼ oz. 60c. .15

CHRYSANTHEMUM. Showy and effective Summer flowering plants, blooming from July until frost; very desirable for the garden and for cut flowers.

Double-flowering Annual Varieties. 2 ft.

- 1805 **Golden yellow**..... ¼ oz. 60c. .15
- 1810 **White**..... ¼ oz. 60c. .15
- 1815 **Mixed.** All colors..... ¼ oz. 40c. .10
- 1820 **Fringed Hybrids.** All colors. ¼ oz. 50c. .15

Single-flowering Annual Varieties. 2 ft.

- 1825 **atrococcineum.** Scarlet. ¼ oz. 35c. .10
- 1830 **Evening Star.** Large golden. ¼ oz. 75c. .15
- 1835 **Morning Star.** Large primrose. ¼ oz. 75c. .15
- 1840 **Northern Star.** Large white, yellow center, with dark disc. ¼ oz. 60c. .15
- 1845 **Mixed.** All colors. Oz. 60c. .10
- 1850 **Grey's Special Mixture.** All colors in souble, single and fringed. ¼ oz. 60c. .15

CHRYSANTHEMUM, Perennial Varieties.

Of great value in the garden and conservatory, blooming from early Autumn to December.

- 1855 **frutescens** (Paris Daisy). Single white, fine for Winter blooming. 1½ ft. ¼ oz. 60c. .15
- 1860 **Chinese, Early Single.** Large, single flowers, freely produced in a large range of colors and quite hardy.25
- 1865 **Japanese Early Double.** Large, double-flowering sorts in fine colors, blooming outside in the Autumn from early sown seed.25
- 1870 **Shasta Daisy.** One of the best hardy white flowers for cutting; large, single flowers.25
- 1875 **Pompon-flowered.** The double, small-flowered hardy sorts; fine colors.25



Hardy Chrysanthemums



Cineraria, Grey's Exhibition Prize

- | No. | | Pkt. |
|------|--|----------------|
| | CINERARIA. One of the most beautiful plants that can be grown for decorative purposes. Seed should not be sown too soon. Sown in June or July, plants large enough for all purposes can be had; the aim should be to secure as hard a growth as possible. | |
| 1880 | Grey's Exhibition Prize. Acknowledged by our customers to be the finest strain grown; of compact branching habit, with exceptionally large flowers of the richest and brightest colors..... | \$1.00 |
| 1885 | grandiflora alba. Large pure white..... | .75 |
| 1890 | atrosanguinea. Large blood red..... | .75 |
| 1895 | azurea. Large, light blue..... | .75 |
| 1900 | kermesina. Large, bright crimson..... | .75 |
| 1905 | Pink Shades. Very fine..... | .75 |
| 1910 | Dwarf Large-flowering Mixed. Dwarf, compact habit with immense trusses of large flowers in rich colors..... | .75 |
| 1919 | stellata Feltham Beauty. A great improvement on the old Stellata variety; a beautiful mixture of many colors..... | .75 |
| 1920 | stella grandiflora. Large flowers, with twisted or fluted petals like the single Cactus Dahlia..... | .75 |
| 1925 | maritima candidissima (Dusty Miller). White foliage for borders..... | ¼ oz. 35c. .15 |
| | CLARKIA. Very showy and profuse flowering hardy annuals of easy culture; very useful for cutting. | |
| 1930 | Double Brilliant. Bright orange. ¼ oz. 50c. | .15 |
| 1935 | Orange King. Orange scarlet. ¼ oz. 75c. | .15 |
| 1940 | Purple Prince. Rich purple. ¼ oz. 50c. | .15 |
| 1945 | Queen Mary. Rose carmine. ¼ oz. 40c. | .10 |
| 1950 | Salmon Queen. Salmon pink. ¼ oz. 50c. | .15 |
| 1955 | Mixed. Extra fine colors..... | ¼ oz. 25c. .10 |
| 1960 | Single Mixed. All colors..... | Oz. 50c. .10 |

- | No. | | Pkt. |
|-------|--|----------------------------|
| | CLEMATIS. Well known as valuable, hardy, profuse flowering, climbing perennials. Seed sown in coldframe or border will germinate freely the next Spring. | |
| 1965 | Jackman's New Hybrids. Elegant large-flowered sorts, and when raised from seed afford a wide range of color... ¼ oz. \$1.00 | \$0.25 |
| 1970 | paniculata. Vigorous grower and covered in Autumn with a cloud of star-like, fragrant white flowers..... | ¼ oz. 35c. .10 |
| 1975 | CLEOME pungens (Spiderflower). An attractive annual rose..... | ¼ oz. 50c. .10 |
| 1976. | alba. White..... | ½ oz. 35c. .15 |
| 1980 | CLIANTHUS dampieri (Glory Pea). A magnificent greenhouse annual, with large, brilliant scarlet, pea-shaped flowers having a black center..... | .25 |
| | CLOVE PINKS. See <i>Dianthus</i> . | |
| 1985 | COBAEA scandens. Popular half hardy, climbing perennial of rapid growth, with large, purple, bell-shaped flowers; blooming first season from seed which should be planted edgewise. 20 ft. ¼ oz. 30c., oz. \$1.00 | .10 |
| 1990 | scandens alba. White flowered..... | .25 |
| 1993 | Mixed Purple and White. | ¼ oz. 30c., oz. \$1.00 .10 |
| | COCKSCOMB. See <i>Celosia</i> . | |
| 2001 | COLCHICUM autumnale (Meadow Saffron, or Fall-blooming Crocus). Bulbous perennial..... | ½ oz. 35c. .10 |
| | COLEUS. Ornamental foliage plants, easily grow from seed. Half hardy perennial. | |
| 2005 | Mixed Hybrids. From a large collection. | .10 |
| 2010 | New Large-leaved Varieties. Extra fine. | .25 |
| 2015 | COLLINSIA, Mixed. Free flowering, hardy annuals of deserved popularity, blooming from June to October, and suited to dry situations..... | ¼ oz. 20c. .10 |
| | COLUMBINE. See <i>Aquilegia</i> . | |
| 2020 | COMMELINA coelestis. Half hardy tuberous-rooted perennial, with-sky-blue flowers; blooms first season. 1½ ft..... | .15 |



Double Clarkia Salmon Queen

No. 2025 **CONVOLVULUS minor, Mixed.** Handsome, hardy annual, with large, richly colored flowers, producing a brilliant effect. 1 ft. Oz. 40c. \$0.16 Pkt.

major. See *Ipomoea*.

COSMOS. One of the most beautiful and useful of the hardy annuals, producing through the season thousands of beautiful flowers. Seed should be sown in May in the open ground. The early varieties will bloom from July till frost. 4 to 6 ft.

Double Crested. Early blooming. A large per cent coming true.

- 2026 **Crimson**..... .25
- 2027 **Pink Beauty.** Rosy pink..... .25
- 2028 **White Queen.** Pure white..... .25
- 2029 **Finest Mixed**..... .25

2030 **Extra Early, Mammoth Midsummer, Mixed.** The blossoms, under ordinary field cultivation, average 4 to 5 inches across, surpassing in size any of the late varieties..... .15

From seed sown in the open ground, the **White** blossoms in exactly 60 days, the **Pink** in 65 days, and the **Crimson** in 70 days.

- 2035 **White.** 4 ft..... ¼ oz. 75c., oz. \$2.50 .15
- 2040 **Pink.** 4 ft..... ¼ oz. 75c., oz. \$2.50 .15
- 2045 **Crimson.** 4 ft..... ¼ oz. 75c., oz. \$2.50 .15
- Mammoth.** Late flowering. 5 ft.
- 2055 **Crimson**..... ¼ oz. 30c., oz. \$1.00 .10
- 2060 **Lady Lenox.** Shell-pink..... ¼ oz. 75c. .15
- 2035 **Lady Lenox.** White..... ¼ oz. 75c. .15

2085 **CUPHEA platycentra** (Cigar Plant). Dwarf half hardy perennial, with bright scarlet, tubular flowers, tipped with black; blooms freely from seed. Fine pot plant. 1 ft... .25

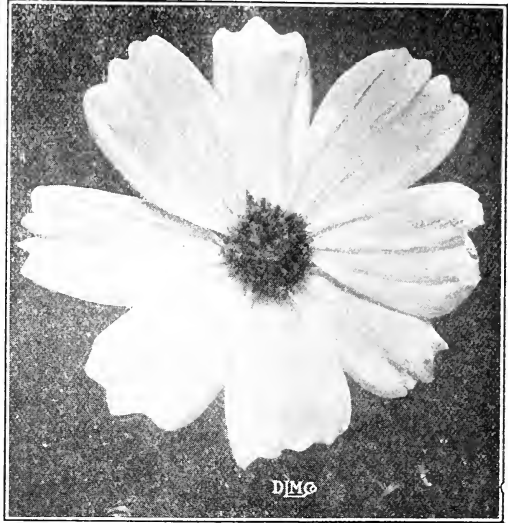

Cosmos

No. Pkt.

CYCLAMEN. The seed we offer is saved by a leading specialist from selected strains of the very best varieties, and cannot fail to produce flowers of the largest size, finest substance and most charming shades of color. July to August is the best time for sowing. Seedlings should be grown on without any check whatever, and when grown cool the results are more satisfactory.

- 2090 **Grey's Giant Crimson**..... \$0.75
- 2095 **Grey's Giant Pink**..... .75
- 2100 **Grey's Giant Salmon King**..... .75
- 2105 **Grey's Giant White**..... .75
- 2110 **Giant Brilliant.** Rich dark crimson..... .75
- 2113 **Carmine Salmon**..... .75
- 2120 **Excelsior.** White, with purple base..... .75
- 2123 **Glory of Wandsbeck.** Dark salmon..... .75
- 2140 **Mrs. L. M. Graves.** Nearly a true scarlet..... 1.00
- 2143 **Perle of Zehlendorf.** Salmon rose..... .75
- 2152 **Rose of Marienthal.** Pink, red eye..... .75
- 2157 **Rose of Zehlendorf.** Soft salmon rose.. .75
- 2175 **St. George.** Flowers identical with our Salmon King, with the decorative foliage of the Rex Begonia..... 1.00
- 2180 **Grey's Giant Mixture.** All colors..... .75

For above named Cyclamen, 100 seeds \$2.50. 1000 seeds \$18.00.

2182 **CYNOGLOSSUM amabile** (Chinese Forget-me-not). Annual of easy culture. Heavenly blue. 18 in..... .15

2185 **CYPHERUS alternifolius** (Umbrella Plant). Numerous erect stems, supporting in an umbellate manner a quantity of glossy, long, narrow leaves; excellent for house or greenhouse. 1 ft..... .25

2190 **Papyrus** (Egyptian Paper Plant). Palm-like foliage; an aquatic or for pots. 5 ft. .25

CYPRESS VINE. See *Ipomoea quamoclit*.

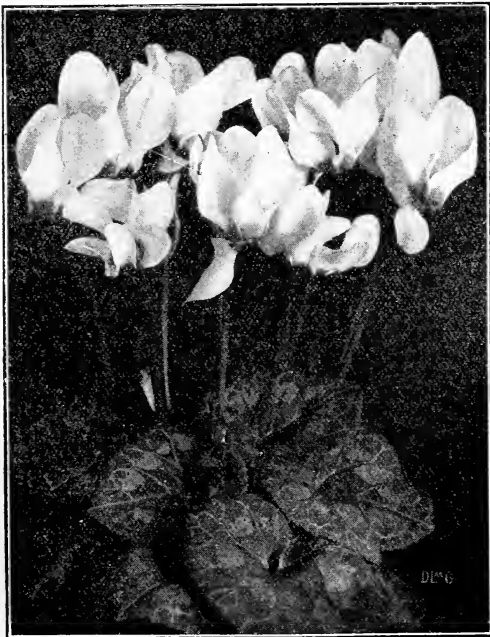

Cyclamen, Grey's Giant White

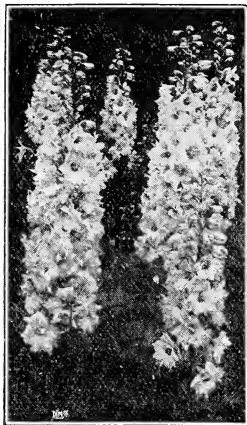

Perennial Delphinium

DAHLIA. This popular flower can be easily raised from seed flowering the same season. Seed should be sown early in gentle heat. Half-hardy perennial. 4 to 6 ft.

No. Pkt.
2195 **Cactus, Double Mixed.** Saved from a fine collection. ¼ oz. \$2.00... \$0.25



Pompon Dahlias

2200 **Paeony-flowered Giant.** Single and semi-double flowers of enormous size, resembling the Peony. ¼ oz. \$2.00 \$0.25
2205 **Pompon, Double Mixed.** Small flowered .25
2210 **Show, Double Mixed.** Large flowered. .25
2215 **Single Giant Perfection.** Surpassing all others in size and colors. ¼ oz. \$1.50 .25

DAISY. See *Bellis perennis*.

DATURA (Trumpet Flower). Handsome, hardy annuals of very rapid growth, with large, trumpet-shaped flowers. 3 ft.

2220 **arboorea** (*Brugmansia*). Single, white, fragrant flowers often 12 inches long .25
2225 **Cornucopia.** White, beautifully marbled with royal purple; fragrant. ¼ oz. 40c. .15
2230 **Golden Queen.** Fragrant, double, golden yellow. ¼ oz. 35c. .15
2235 **White Queen.** Fragrant, double, white. ¼ oz. 35c. .15
2240 **Double Mixed.** All sorts. ¼ oz. 35c. .15

DELPHINIUM, Annual Varieties (Larkspur). Among the best of hardy annuals, lasting a long time in flower. The plants should be transplanted or thinned out to avoid overcrowding and to secure the branching habit.

Grey's Imperial. A superior branching strain. Double flowers; excellent for cutting. Offered in the following choice colors. 2 ft.

2245 **Apple Blossom Pink** ¼ oz. 50c. .15
2250 **Brilliant Carmine** ¼ oz. 50c. .15
2255 **Bright Rose** ¼ oz. 50c. .15
2260 **Dark Blue** ¼ oz. 50c. .15
2265 **Light Blue** ¼ oz. 50c. .15
2270 **Newport Scarlet.** Beautiful. ¼ oz. 60c. .15
2275 **White** ¼ oz. 50c. .15
2280 **Mixed.** All finest colors. ¼ oz. 50c. .15
2285 **Collection of 6 colors, separate.** 75

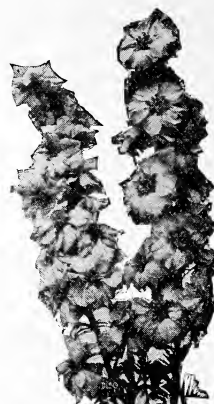

Annual Delphinium

No. Pkt.
2262 **EXQUISITE.** A beautiful stock flowered variety of the Annual Larkspur. Tall, semi-double. Color, soft pink. ¼ oz. 40c. .15

2300 **Azure Fairy.** Clear, light blue. 15 in. .25

2301 **Blue Gem.** Deep blue, 9 to 12 inches. .15
2305 **Blue Butterfly.** Bright blue. 15 in. ¼ oz. \$1.00 .25

DELPHINIUM, Hardy Perennial Varieties. The great improvement effected in these splendid border perennials strongly recommends their culture from seed. They are of easy culture and produce splendid spikes of bloom through the Summer. When sown early they usually bloom in September. 1 to 5 ft. Pkt.

2310 **Columbia Hybrids.** An exceptionally fine strain selected from the best large flowering varieties, immense spikes. ¼ oz. \$1.50 \$0.25

2315 **Kelway's Show, Mixed.** Saved from their celebrated collection of show varieties, which is undoubtedly the largest and finest collection of this popular perennial in existence. 1-16 oz. \$1.50 .50

2325 **Belladonna.** Clear turquoise blue; the ever-blooming, hardy larkspur; if sown early will bloom in late Summer and Autumn. ½ oz. \$1.25 .25

2326 **bellamosa.** Deep blue. ⅛ oz. \$1.25 .25
2333 **cashmerianum.** Very large, beautiful blue. ⅛ oz. \$1.00 .25

2340 **Chinese (grandiflorum).** Large, bright gentian blue. 1 ½ ft. ¼ oz. 85c. .10

2345 **Chinese album.** Large, white. ¼ oz. 85c. .10

2347 **Chinese Reddish Lilac.** ¼ oz. 85c. .10

2350 **Chinese Tom Thumb.** Clear, ultra-marine blue. 9 in. ¼ oz. 85c. .10

2355 **elatum** (*Bee Larkspur*). Rich blue with darker centers. 4 ft. ¼ oz. 75c. .15

2360 **formosum.** Dark blue, white eye. 2 ½ ft. ¼ oz. \$1.00 .10

2365 **formosum coelestinum.** Light blue. 2 ½ ft. ½ oz. 1.25 .25

2370 **Hybrids, Pale Blue Shades.** From newest large flowering sorts. ¼ oz. \$1.50 .25

2375 **Hybrids, Dark Blue Shades.** From new-large flowering sorts. ¼ oz. \$1.25 .15
2380 **Zalil.** Beautiful yellow. 3 ft.25

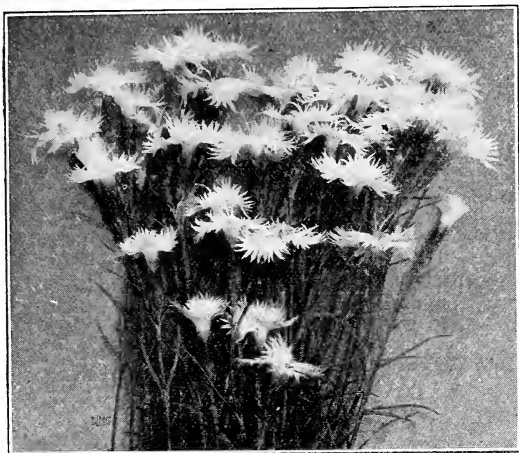

Dianthus, Hardy Carnations

No. **DIANTHUS, or PINKS, Annual Varieties.** Pkt.

These are really hardy biennials though treated as annuals, and bloom the first season from early Summer until frost. They are beautiful border plants and deserve a place in every garden.

DOUBLE-FLOWERING VARIETIES

- 2385 **chinensis Mixed.** Indian pink. ¼ oz. 40c. \$0.10
- 2390 **diadematus, Mixed.** Diadem pink. ¼ oz. 75c. .10
- 2395 **heddewigi, Mixed.** Japan pink. ¼ oz. 60c. .10
- 2400 **laciniatus, Mixed.** Lace pink. ¼ oz. 60c. .10
- 2405 **latifolius, Mixed.** Large flowers, resembling the Sweet William in shades of rose, crimson and maroon. ¼ oz. 75c. .10
- 2410 **nobilis, Mixed (Royal Pink).** Largest size and brightest colors. ¼ oz. 50c. .10
- 2415 **Blood Red.** Deep color; extra. ¼ oz. 75c. .10
- 2420 **Mourning Pink.** Deep crimson, white edge. ¼ oz. 75c. .10
- 2425 **Salmon Pink (Salmon King)** ¼ oz. \$1.00 .20
- 2430 **White.** Very fine variety. ¼ oz. 75c. .10

SINGLE-FLOWERING VARIETIES

- 2435 **Crimson Belle.** Dark red. ¼ oz. 75c. .10
- 2440 **The Bride.** White, purple eye. ¼ oz. 60c. .10
- 2445 **Vesuvius.** Brilliant scarlet. ¼ oz. 50c. .10
- 2450 **Mixed.** Finest colors and sorts. ¼ oz. 50c. .10

DIANTHUS caryophyllus (Carnation Pink).

- 2455 **Riviera Market (Giant of Nice).** Superior class of perpetual flowered Carnations; saved from the finest and largest blooms. .50
- 2460 **Marguerite, Giant Mixed.** Improved and very large double flowered strain of this early flowering Carnation which blooms in four months from time of sowing, and is composed of the best colors. ½ oz. \$1.50 .25
- 2465 **Giant Scarlet.** ½ oz. 1.50 .15
- 2470 **Giant Yellow.** ½ oz. 1.75 .20
- 2475 **Giant White.** ½ oz. 1.75 .20

Chabaud's Giant Improved French Carnation. Half hardy perennial. Seed sown early inside will bloom in six months. Clove-scented.

- 2479 **Cardinal Red (Sparkler)** .25
- 2481 **Crimson (Nero)** .25
- 2483 **Flesh Pink** .25
- 2491 **Rose Pink (The Pearl)** .25
- 2493 **White (Jeanne Dionis)** .25
- 2496 **Yellow (Marie Chabaud)** .25
- 2497 **Finest Mixed** .25

- No. 2500 **DIANTHUS deltoides (Maiden Pink).** Beautiful, hardy sort for rockeries, sunken gardens, etc. The flowers are bright pink, small and in abundance from May to Aug. 6 in. ¼ oz. \$1.00 \$0.15
- 2505 **deltoides alba.** White flowers. ¼ oz. 1.00 .15
- 2508 **DIANTHUS (Hardy Carnation) allwoodi.** A new race of hardy pinks, very free flowering and producing about 75 per cent of double flowers. Mixed colors. 1.00
- plumarius (Hardy Garden, or Clove Pink).** Very free flowering, with a strong clove fragrance; perfectly hardy. A little mulching in Winter is beneficial.
- 2520 **scoticus fl. pl. Perfection.** A prize strain of double Scotch or florist's Pinks in finest colors. .50
- 2525 **Double Mixed.** Free blooming strain, with double and semi-double flowers of spicy odor; in finest colors. ¼ oz. \$1.75 .25
- 2530 **DICTAMNUS, Mixed (Fraxinella).** Very showy, hardy perennial. ¼ oz. \$1.00 .15
- 2532 **DIDISCUS coerulea (Blue Lace Plant).** Hardy annual. ½ oz. 60c. .25
- DIGITALIS (Foxglove).** Hardy perennials of easy culture, valuable for shrubby borders, woodland walks, partial shady places, and should be more extensively grown; blooms in June and July. 3 to 4 ft.
- 2535 **gloxiniaeflora, Mixed.** Fine colors, spotted in the throat. ¼ oz. 50c. .15
- 2540 **grandiflora.** Light yellow; fine. ¼ oz. 35c. .10
- 2545 **Ivery's Spotted.** An extra choice strain of beautifully spotted flowers. ¼ oz. 50c. .10
- 2550 **monstrosa, Mixed.** Beautiful colors, with one enormous flower at top of spike. ¼ oz. 75c. 15
- 2555 **purpurea, Mixed (Common Foxglove).** All colors. ¼ oz. 40c. .10
- 2560 **Red.** ¼ oz. 50c. .15
- 2565 **Rose.** ¼ oz. 50c. .15
- 2570 **White.** ¼ oz. 50c. .10



Dianthus, Double-Flowering



Dimorphotheca

- | | | |
|------|---|--------|
| No. | | Pkt. |
| 2575 | DIMORPHOTHECA aurantiaca (African Marguerite). Beautiful Transvaal annual, with a profusion of rich, orange gold flowers throughout the season. 15 in. $\frac{1}{4}$ oz. 60c. | \$0.15 |
| 2580 | New Hybrids . Rich colors. $\frac{1}{4}$ oz. 60c. | .15 |
| | DOLICHOS (Hyalanth Bean). A beautiful quick growing annual climber; flowering freely in erect racemes all Summer; the seed pods are quite ornamental. 10 ft. | |
| 2585 | Darkness . Rich purple-violet flowers and purple stems and seed pods. $\frac{1}{4}$ oz. 40c. | .10 |
| 2590 | Daylight . Snow white; excellent. $\frac{1}{4}$ oz. 40c. | .10 |
| 2595 | lablab, Mixed . Purple and white. $\frac{1}{4}$ oz. 30c. | .10 |
| | DRACAENA . Decorative plants, with long, graceful foliage; valuable for vases and house decoration; tender perennials. | |
| 2600 | australis . Dark green leaves, 2 to 4 in. wide. $\frac{1}{4}$ oz. 50c. | .15 |
| 2605 | indivisa . Narrow green foliage. $\frac{1}{4}$ oz. 30c. | .10 |
| 2610 | Ornamental Foliage Sorts . Including the best and most brilliant colors. $\frac{1}{4}$ oz. 50c. | .25 |
| 2615 | DRACOCEPHALUM moldavica . Fine hardy annual, with spikes of violet blue, Salvia-shaped flowers. $\frac{1}{4}$ oz. 50c. | .10 |
| 2620 | ECHINACEA helianthus (Red Perennial Sunflower). Large, purplish red flowers freely produced through the whole Summer. 5 ft. $\frac{1}{4}$ oz. 50c. | .15 |
| 2625 | purpurea . Large purple, black disc. 3 ft. $\frac{1}{4}$ oz. 50c. | .15 |
| 2630 | ECHINOCYSTIS lobata (Wild Cucumber). Rapid growing annual climbers, with ornamental seed pods and large seed. Soak the seed in warm water over night and plant the eye down. 20 ft. $\frac{1}{4}$ oz. 50c. | .10 |
| 2635 | EDELWEISS (Gnaphalium leontopodium). Charming Swiss Alpine plant, with lovely star-shaped, white everlasting flowers, so much prized by tourists for cutting; fine for rockwork or exposed positions. $\frac{1}{4}$ oz. 50c. | .25 |

- | | | |
|------|---|--------|
| No. | | Pkt. |
| | EREMURUS . Most attractive perennials, bearing in Summer massive spikes; they require rich soil. | |
| 2640 | himalaicus . Creamy white. 6 to 8 ft. $\frac{1}{4}$ oz. 50c. | \$0.25 |
| 2645 | robustus . Soft flesh pink. 8 ft. $\frac{1}{4}$ oz. 50c. | .25 |
| | ERIGERON (Midsummer Daisy). Effective hardy perennial, with numerous large daisy-like flowers on stout, many-branched stems; from May to Oct. $1\frac{1}{2}$ ft. | |
| 2650 | aurantiacus hybridus . Shades of orange and yellow. $\frac{1}{4}$ oz. 50c. | .25 |
| 2655 | speciosus hybridus grandiflorus . Large mauve color; excellent for cutting. $\frac{1}{4}$ oz. 50c. | .15 |
| 2660 | ERYNGIUM amethystinum . A handsome, hardy perennial, with beautiful foliage and flowers of a lovely blue. Can be dried for Winter. July, August. 3 ft. $\frac{1}{4}$ oz. 75c. | .15 |
| 2665 | ERYSIMUM, Golden Gem . Golden yellow hardy biennial, like a miniature Wallflower, effective for Spring bedding. $\frac{3}{4}$ ft. $\frac{1}{4}$ oz. 85c. | .10 |
| | ESCHSCHOLTZIA (California Poppy). Profuse flowering plants, with bright, showy flowers; excellent for bedding, massing or ribbon work. Hardy annual. June to Oct. 1 ft. | |
| 2670 | californica . Yellow, orange center. Oz. 50c. | .10 |
| 2675 | alba . White. $\frac{1}{4}$ oz. 50c. | .10 |
| 2680 | Carmine King . Deepest carmine. $\frac{1}{4}$ oz. 50c. | .10 |
| 2685 | crocea . Orange color. $\frac{1}{4}$ oz. 50c. | .10 |
| 2690 | Dainty Queen . Lovely, delicate pink. $\frac{1}{4}$ oz. 50c. | .10 |
| 2693 | The Geisha (New). Fluted petals orange crimson. $\frac{1}{4}$ oz. 50c. | .15 |
| 2695 | Mandarin . Orange, shaded rose. Oz. \$1.00 | .10 |
| 2700 | maritima, Golden West . Giant orange and yellow. $\frac{1}{4}$ oz. \$1.00 | .10 |
| 2705 | Rose Cardinal . Beautiful rose. $\frac{1}{4}$ oz. 50c. | .10 |
| 2710 | Mixed . All colors. $\frac{1}{4}$ oz. 50c. | .10 |
| | EUPATORIUM . Free blooming, hardy perennials, largely grown for cut flowers, and deserves a place in every border. Blooms first season from seed. Aug. to Oct. | |
| 2715 | ageratoides . Dense heads of small, white flowers. 4 ft. $\frac{1}{4}$ oz. 75c. | .10 |
| 2720 | frazieri . Snow white. 2 ft. $\frac{1}{8}$ oz. 50c. | .15 |
| 2725 | EUPHORBIA heterophylla (Mexican Fire-plant). The beautiful orange-scarlet bracts completely cover the plant almost the entire season. Annual. 2 to 3 ft. $\frac{1}{4}$ oz. 50c. | .15 |
| 2730 | variegata (Snow-on-the-mountain). Foliage striped and margined with white. Annual. $1\frac{1}{2}$ to 2 ft. $\frac{1}{4}$ oz. 75c. | .10 |
| 2735 | EXACUM affine . Dwarf, showy, tender annual for pot culture, with clusters of fragrant lilac flowers. 1 ft. $\frac{1}{4}$ oz. 50c. | .25 |
| | FERNS . A well-known, graceful and attractive class of plants, extensively grown for house decoration in Winter and for shady positions and rockeries during Summer. | |
| 2740 | Greenhouse Varieties, Finest Mixed . $\frac{1}{4}$ oz. 50c. | .25 |
| 2745 | Hardy Varieties, Mixed . Finest sorts for outdoor growing. $\frac{1}{4}$ oz. 50c. | .25 |
| 2750 | Adiantum cuneatum (Maidenhair Fern). $\frac{1}{4}$ oz. 50c. | .25 |
| | FEVERFEW . See <i>Matricaria</i> . | |
| | FORGET-ME-NOT . See <i>Myosotis</i> . | |
| | FOUR O'CLOCK . See <i>Mirabilis</i> . | |
| | FOXGLOVE . See <i>Digitalis</i> . | |
| 2755 | FRANCOA ramosa (Bridal Wreath). The long sprays of pure white flower; are largely used for table decoration. An excellent decorative greenhouse plant. $2\frac{1}{2}$ ft. $\frac{1}{4}$ oz. 50c. | .25 |

No.		Pkt.
2760	FREESIA, New Hybrids Mixed. Beautiful variety, with new colors and delicate shades, blooming in six to eight months after sowing.	\$0.25
2765	FUCHSIA, Double and Single Mixed. The raising of Fuchsias from seed is interesting, there always being the possibility of securing something new and distinct; the seed offered is saved from a choice collection. .	.50
	GAILLARDIA (Blanketflower). Beautifully showy annuals, giving a profusion of brilliant flowers during the Summer and Autumn. Fine for cutting. 2 ft.	
2770	Single, Finest Mixed. All colors. .Oz. 75c.	.10
2775	Double, Finest Mixed (Lorenziana). A rich mixture.	¼ oz. 50c. .10
2780	amblyodon. Single, deep red.	¼ oz. 50c. .15
	GAILLARDIA grandiflora (Blanketflower). One of the most brilliant of all hardy perennials, and constant bloomer from June till frost; excellent for cutting. 2 ft.	
2785	kermesina splendens. Large, deep crimson, with golden margin.	¼ oz. 60c. .15
2790	maxima. Large, pure yellow.	¼ oz. 50c. .15
2795	superba. Large, red and yellow.	¼ oz. 50c. .15
2800	Finest Hybrids. Saved from the choicest named varieties.	¼ oz. 50c. .15
2805	GAURA lindheimeri. Half-hardy annual of graceful habit, with numerous sprays of rosy white flowers throughout the Summer, Fine for vases. 2 ft.	¼ oz. 50c. .10
2810	GENISTA canariense (Broom). Handsome, half-hardy perennials for room decoration, with bright yellow flowers. 2 ft.15
2815	andreaana. Crimson and yellow; handsome.15
2820	GENTIANA acaulis (Alpine Blue Gentian). Dwarf, early, Spring-flowering, Alpine perennial, with intense blue, bell-shaped flowers. 6 in.	¼ oz. 85c. .15
2825	lutea (Giant Gentian). Bright yellow flowers in whorls on stems. 4 ft. high.15
	GERANIUM. Popular plants, easily raised from seed. Half-hardy perennial.	
2830	Apple-scented. Fragrant foliage.25
2835	Show Pelargoniums (Lady Washington). Newest large-flowered Show varieties.50
2840	zonale, Finest Mixed. Specially saved.15
2845	Double, Finest Mixed. Finest sorts.25
2850	GERARDIA, New Hybrids. Spikes of handsome, Foxglove-like flowers; very free-flowering perennials, blooming first season from seed and hardy in sheltered situations. July to September. 2 ft.	½ oz. 25c. .10
2855	GERBERA jamesoni (Tra-svaal Daisy) Beautiful daisy of a brilliant orange-vermilion color, on long stems, blooming almost the whole year if given greenhouse protection during Winter.50
2860	Jamesoni Hybrids. New hybrids of the preceding which are more hardy and easily grown. The colors are rich and delicate, with a wonderful range from pure white through orange, salmon, rose, cerise, to ruby red and violet.50
	GEUM. Showy, hardy perennial of easy culture, and well adapted for the flower garden; fine for cutting. July to Oct. 2 ft.	
2875	coccineum. Bright scarlet.	¼ oz. 30c. .10
2876	Mrs. Bradshaw. Double scarlet.25
2877	Lady Stratheden. Beautiful orange.25

No.		Pkt.
2865	GESNERIA, Mixed Hybrids. Greenhouse bulbous plants with beautiful marked velvety foliage and handsome spikes of brilliant colored flowers.	\$0.50
2880	GILIA, Finest Mixed. Showy, hardy annual, blooming from early in the season until frost. 1 ft.	¼ oz. 30c. .10
2885	GLAUCUM flavum tricolor (Horned-poppo). Free flowering, hardy annuals, with handsome silvery foliage and orange-scarlet and black flowers in July. 2 ft.	¼ oz. 50c. .15
	GLOBE AMARANTH (Gomphrena). Showy annual everlasting; the flowers resemble clover heads, and when dried are used for Winter decoration; fine for bedding. 1½ ft.	
2890	Purple	¼ oz. 20c. .10
2895	Orange	¼ oz. 20c. .10
2900	White	¼ oz. 20c. .10
2905	Mixed. All colors.	¼ oz. 20c. .10
	GLOXINIA. The seed offered has been selected from the finest erect flowering varieties, and will give blooms of finest quality. For a succession of flowers from seed, sowings should be made at intervals from January to May. A moist heat of from 65 to 70 degrees is best to start them in.	
2910	Grey's Invincible Prize. This has the reputation of being the finest strain grown, very free flowering, with large, open flower in the greatest variety of colors.	1.00
2915	Giant Mixed. A prize strain, with large flowers of richest colors.50



Guem, Mrs. Bradshaw

No.		Pkt.
	GODETIA (Satin Flower). Handsome, hardy annuals, blooming profusely from July to Oct. Large, wide open flowers of shining satiny texture, and of the most delicate and brilliant colors. 1½ ft.	
2920	Duchess of Albany. Satiny white.....	¼ oz. 50c. \$0.10
2925	Double Rose. Large, bright rose. ¼ oz. 75c. .15	
2930	gloriosa. Brilliant blood red. ¼ oz. 60c. .10	
2935	Lady Satin Rose. Rich rose-pink.	¼ oz. 75c. .15
2940	Mixed. Beautiful colors.	¼ oz. 35c. .10
	GOURDS, Ornamental. Quick growing vines, desirable for covering arbors, walls, etc., and producing useful and ornamental fruit in great variety of shapes and colors. Tender annual. 15 to 20 ft.	
2945	Collection of 12 sorts	1.00
2950	Angora. White spotted fruit.....	Oz. 40c. .10
2955	Apple Shape. Striped fruit.....	Oz. 40c. .10
2960	Bottle Shape. White and green.....	Oz. 40c. .10
2965	Dipper Shape or Calabash	Oz. 40c. .10
2970	Dishcloth or Sponge	Oz. 40c. .10
2975	Egg Shape. Useful as nest eggs.....	Oz. 40c. .10
2980	Gooseberry. Very small.....	Oz. 60c. .10
2985	Hercules Club. 4 ft. long.....	Oz. 40c. .10
2990	Orange Shape. Mock orange.....	Oz. 40c. .10
2995	Pear Shape. Striped.....	Oz. 40c. .10
3000	Serpent Shape. 4 to 5 ft. long.....	Oz. 40c. .10
3005	Sugar Trough	Oz. 40c. .10
3010	Mixed Sorts. In great variety.....	Oz. 30c. .10

GRASS, Ornamental. See page 62.

3015	GREVILLEA robusta (Silk-oak). Beautiful evergreen, with fern-like foliage, magnificent for decorative purposes, and well adapted for house culture. Tender perennial.....	¼ oz. 50c., oz. \$1.50 .15
------	--	----------------------------

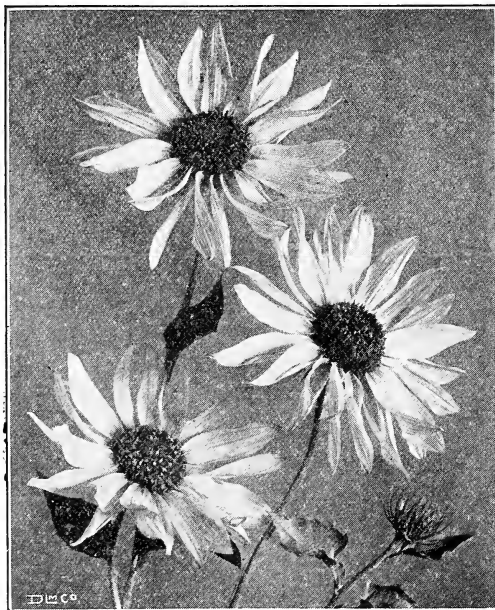

Helianthus cucumerifolius stella

No.		Pkt.
	GYPSOPHILA (Babysbreath). Extremely light and graceful, hardy plants of easy growth, flowering from June to Sept. Useful for cutting to mix with other flowers.	
3020	elegans alba grandiflora. Large, white, annual.....	¼ oz. 15c., oz. 50c. \$0.10
3025	elegans rosea. Rose-pink, annual.....	Oz. 50c. .10
3030	paniculata. Pure white, hardy.....	¼ oz. 50c. .10
3035	fi. pl. Double white, hardy. This variety produces only about 60 per cent of double flowering plants.....	.25
	HELENIUM. A most valuable hardy perennial, very striking and fine for cutting as it gives an enormous crop of flowers in the late Summer and Autumn. 5 ft.	
3045	autumnale superbum. Golden; fine....	.25
3050	bigelowi. Golden yellow, with black center.	.15
3055	HELIANTHEMUM mutabile. Dwarf hardy perennial, with brilliant flowers of various colors; very profuse in bloom and suited for dry soil and rockeries. June to Sept. 6 in.....	¼ oz. 25c. .10
	HELIANTHUS (Sunflower). Well-known hardy annuals, the small flowering sorts being very useful for cutting, while the larger sorts are very ornamental and useful, blooming all Summer.	
3060	Double Californian. Deep yellow. 5 ft. Oz. 50c. .10	
3065	Double Chrysanthemum-flowered. Orange yellow; fine for cutting. 5 ft. Oz. 60c. .10	
3070	Dwarf. Deep yellow. 3 ft.	Oz. 50c. .10
3075	globosus fistulosus. Large, globe-shaped, rich orange color. 7 ft.	Oz. 30c. .10
3080	Single cucumerifolius (Miniature Sunflower). Small, bright yellow, with black center. 4 ft.	Oz. 75c. .10
3090	cucumerifolius stella. Golden yellow. The largest miniature sort. 4 ft.	Oz. \$1.00 .10
3095	giganteus uniflorus. One immense flower a foot or more across.	Oz. 35c. .10
4000	Giant Russian. Large. 6 ft.	Oz. 20c. .10
4002	Golden Fleece. Small cactus flowers, golden yellow, dark center.....	.15
4005	Sutton's Red. Deep crimson, shading lighter toward the points which are yellow.	¼ oz. 50c. .15
4010	Perennial Hybrids. The flowers vary in shades, size and form.....	¼ oz. \$1.00 .15
	HELICHRYSUM, Double Flowered. Pretty annual everlasting, blooming all Summer; fine in mixed borders and useful as dried flowers for Winter for which purpose they should be gathered before being fully open. 2 ft.	
4015	Mixed	¼ oz. 50c. .10
4016	Canary Yellow	¼ oz. 50c. .10
4017	Fireball Deep Crimson	¼ oz. 50c. .10
4018	Salmon	¼ oz. 50c. .10
	HELIOTROPE. A universal favorite on account of its delicious fragrance; excellent for cutting. Half-hardy perennial.	
4025	Grey's Giant Dwarf. Splendid strain of low, compact growth, with immense umbels of fragrant rich colored flowers.	½ oz. 85c. .25
4030	Giant Hybrids. Mammoth, sweet-scented flowers in great variety.....	½ oz. 85c. .25
4035	Mixed Dark Blue Shades	½ oz. 50c. .15
4040	HELLEBORUS Mixed Hybrids (Christmas Rose). Largely cultivated for their flowers in Midwinter, at which time they will bloom with only the protection of a coldframe. Hardy perennial. 1 ft.....	.25

No.		Pkt
	HESPERIS matronalis (Sweet Rocket). Fragrant Spring flowering hardy perennial, growing freely in ordinary soils.	
4045	Dwarf Pure White. Early. 1 ft. ¼ oz. 50c.	\$0.15
4050	Pure White. 3 ft. Oz.	\$1.50 .10
4055	Purple. 3 ft. Oz.	1.50 .10
4060	Mixed. Purple and white. Oz.	1.00 .10
4064	HEUCHERA choice Hybrids. Dwarf hardy perennials. Spikes of numerous small bell-shaped flowers, well above the foliage. 1 ft.	25
4065	Sanguinea Splendens. Brilliant crimson.	25
	HIBISCUS. A showy class of plants suitable for mixed beds or borders, with large and beautifully colored flowers. Free flowering. Hardy perennials, unless noted.	
4070	africanus. Buff, with maroon center. Hardy annual. July to October. 2 ft. ¼ oz. 35c.	.10
4075	Crimson Eye. Large, pure white, crimson center, July to Sept. 4 ft. ¼ oz. 50c.	.15
4080	Moscheutos Rose. Large, light rose. July to Oct. 4 ft. ¼ oz. 50c., oz. \$1.50	.15
4085	Moscheutos White. Large, pure white. July to Oct. 4 ft. ¼ oz. 50c., oz. \$1.50	.15
4087	Moscheutos Hybrid. Large flowering, mixed. ¼ oz. 50c., oz. \$1.50	.15
	HOLLYHOCK. One of the oldest garden favorites, and finest of our Autumn flowers. Seed sown in February and potted on will bloom the same season, and July sown seed the next season. They require a well drained, deep, rich soil. Hardy biennial.	
4095	Collection of the following 6 colors.	.75
5000	Double Superb, Mixed. An improved strain. ¼ oz. \$1.00, oz. \$3.00	.15
5005	Double Crimson. ¼ oz. 1.00, oz. 3.00	.15
5008	Newport Pink. ¼ oz. 1.00, oz. 3.00	.15
5015	Rose Pink. ¼ oz. 1.00, oz. 3.00	.15
5020	Royal Scarlet. ¼ oz. 1.00, oz. 3.00	.15
5025	Snow White. ¼ oz. 1.00, oz. 3.00	.15
5030	Yellow. ¼ oz. 1.00, oz. 3.00	.15
5035	Single Mixed. ¼ oz. 75c.	.15
5031	Flesh Color. ¼ oz. 1.00	.15
5032	Pink. ¼ oz. 1.00	.15
5033	Red. ¼ oz. 1.00	.15
5034	Rose. ¼ oz. 1.00	.15
5036	White. ¼ oz. 1.00	.15
5037	Yellow. ¼ oz. 1.00	.15
5040	Allegheny. Large fringed double and semi-double flowers of silky texture in various colors. ¼ oz. 60c., oz. \$2.00	.10
	EVERBLOOMING HYBRIDS (Annual). Beautiful flowers in all colors and shades, blooming readily the first season.	
5045	Double Mixed. ¼ oz. 75c.	.15
5050	Single Mixed. ¼ oz. 60c.	.15
5055	HONESTY, Mixed (Lunaria biennis). Early and free flowering hardy biennial. The seed pods, which are flat and broad, look like transparent silver and are much prized for Winter decoration. 2 ft. ¼ oz. 50c.	.10
	HUMULUS (Hop). The annual sorts are rapid growing climbers, with handsome foliage, which does not suffer from heat or the attacks of insects. The perennial sort produces the noted hop of commerce, and is a fine climber. 15 to 20 ft.	
5060	japonicus. Green foliage. ¼ oz. 30c.	.10
5065	variegatus. Variegated foliage. ¼ oz. 30c.	.10
5070	lupulus. Hardy perennial. ¼ oz. 40c.	.10

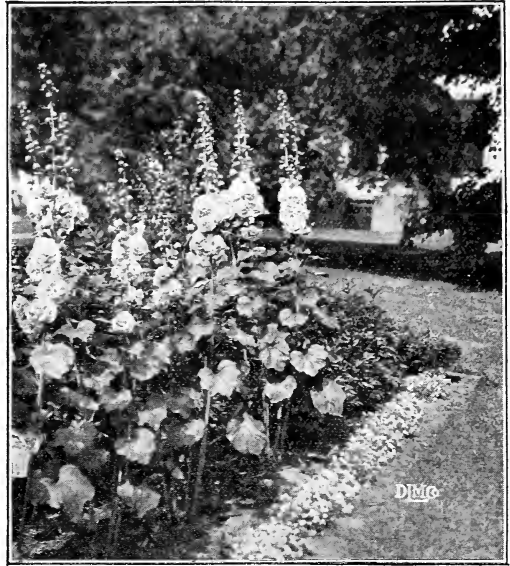

Hollyhocks

No.		Pkt.
5075	HUNNEMANNIA fumaraeifolia (Giant yellow Tulip Poppy, or Bush Eschscholtzia). Perennial, with large, yellow, Poppy-like flowers throughout the season. Blooms in three months from seed. 2 ft. ¼ oz. 50c.	\$0.10
	IBERIS (Hardy Candytuft). Free flowering compact perennials, making a beautiful display early in the season; suitable for rockeries and borders; fine for cutting. 1 ft.	
5080	gibraltarica. Very large flowers of a delicate lilac color. ¼ oz. \$1.50	.15
5085	sempervirens. The evergreen Candytuft with glossy, deep green foliage and white flowers. ¼ oz. \$1.50	.15
	Annual Varieties. See Candytuft.	
5090	ICE PLANT. Half-hardy annual with leaves and stems thickly covered with sparkling ice-like globules. Fine for vases and piazza boxes, also for garnishing. Flowers white, 6 in. ¼ oz. 25c.	.10
	IMPATIENS (Sultan's or Zanzibar Balsam). A very fine, tender perennial for pot culture in the house or greenhouse, and very useful for Summer bedding, as they are in bloom continually.	
5095	holsti. Large, brilliant vermilion. 1 ½ ft.	.25
5100	holsti Hybrids. Choice colors of these large flowered new sorts. 1 ½ ft.	.25
5105	sultani. Large, rich bright rose. 1 ft.	.25
5110	INCARVILLEA delavayi. Fine half-hardy tuberous-rooted perennial, with large bright rose-colored, bell-shaped flowers in clusters. The tubers can be taken up and stored through the Winter. 2 ½ ft.	.25
5115	INULA glandulosa grandiflora. Very bold and handsome hardy perennial, with large orange-yellow flowers. 2 ft.	.25



Lobelia

No.		Pkt.
	IPOMOEA. Splendid rapid growing climbers, with large, bright colored flowers, they are exceedingly pretty when grown among other climbers. Hardy annual. 15 ft.	
5120	purpurea, Finest Mixed (Morning-glory, Convolvulus major). Fine colors. Oz. 25c., ¼ lb. 75c.	\$0.10
5125	purpurea, Double Mixed. Oz. 50c.	.10
5130	coccinea (Star Ipomoea). Scarlet star-shaped flowers in profusion. Oz. 60c.	.10
5135	Heavenly Blue. Immense beautiful flowers of bright sky blue; seed should not be sown outside till ground is warm. ¼ oz. \$1.00	.15
5140	imperialis japonica (Japanese Giant). Most beautiful strain, with immense flowers of finest colors and markings. Oz. 50c.	.10
5145	noctiflora hybrida (Moonflower). Large fragrant, white flowers. Oz. \$1.00	.10
5150	setosa. Enormous leaves and large, rose-colored flowers in clusters. Oz. 75c.	.10
	quamoclit (Cypress Vine). Finely cut, fern-like foliage and masses of brilliant star-shaped flowers.	
5155	Bright Scarlet. Oz. \$1.00	.10
5160	Pure White. Oz. 1.00	.10
5165	Mixed. Scarlet, white and pink. . . Oz. 1.00	.10
5170	hybrida (Cardinal Climber). Large, brilliant cardinal-red flowers in clusters, all Summer.	.25
5175	IRIS, Mixed Varieties. All sorts and colors of this beautiful Spring and Summer-blooming hardy perennial. ¼ oz. 75c.	.10
	JACOB'S LADDER. See Polemonium.	
	JAPANESE IVY. See Ampelopsis vitichi.	
	KENILWORTH IVY. See Linaria cymbalaria.	
5180	KOCHIA trichophylla (Mock Cypress, or Belvedere). A pretty half-hardy annual, forming compact bushes about 2½ ft. high, with small, feathery, light green foliage which changes to a crimson hue in September. ¼ oz. 25c.	.10
No.	LANTANA. Most elegant and showy bedding Pkt. plants of as easy culture as Verbena or Geranium; flowers freely produced in beautiful clusters, and constantly changing in hue.	
5185	New Dwarf Bedding Hybrids. 1 ft. \$0.25	
5190	Tall Hybrids. 2 ft. ¼ oz. 50c.	.15
	LARKSPUR. See Delphinium.	
	LATHYRUS latifolius (Perennial Pea). Handsome, free-flowering, hardy perennial climber of great beauty, with clusters of elegant, Sweet Pea-like flowers in great profusion; useful as a cut flower. 6 ft.	
5195	albus. Pure white; very desirable. ¼ oz. 75c.	.15
5200	Pink Beauty. Bright rosy pink. ¼ oz. 50c.	.10
5205	splendens. Rich crimson. ¼ oz. 50c.	.10
5210	Mixed. All colors. . . . ¼ oz. 40c., oz. \$1.25	.10
	LAVATERA trimestris (Bar Harbor Marsh Mallow). Large flowered variety, hardy annual, allied to the Mallows, covered during the entire Summer with its pretty and showy blossoms. 2½ ft.	
5215	splendens. Rose. ¼ oz. 50c.	.15
5220	splendens. White. ¼ oz. 50c.	.15
5225	LAVENDULA vera (Sweet Lavender). Chiefly cultivated for the delicious and lasting fragrance of its flowers. Hardy perennial. July to September. 2 ft. Oz. 75c.	.15
5230	LEPTOSYNE maritima. Free flowering hardy annual, with large single yellow Coreopsis-like flowers on long stems; fine for cut flowers. August to October. 2 ft. ¼ oz. \$1.00	.15
5235	LIATRIS spicata (Blazing-star). Desirable hardy perennial. The brilliant rosy-purple flowers are on long spikes, and freely produced. July to September. 2 ft.	.15
	LINARIA (Toadflax). Annual.	
5242	aparinoides Mixed Hybrids.15
5243	marocana Hybrid Mixed.15
5244	bipartita Mixed (Snapdragon).15
5245	cymbalaria (Kenilworth Ivy). Beautiful trailing plants for vases, baskets or rock work.15
	LINUM. A valuable class of plants flowering for months and worthy of extended cultivation in masses or clumps in mixed borders. 1½ ft.	
5250	grandiflorum rubrum. Brilliant dark scarlet, profuse flowering annual. . Oz. 75c.	.10
5255	Mixed Perennial Sorts. Fine. ¼ oz. 50c.	.10
	LOBELIA. Most useful plants, free flowering and of easy culture. For bedding, edging, vases, etc., they are exceedingly fine. Treated as annuals, except the Cardinals varieties, which are hardy perennials, and thrive best in rather moist places.	
5260	cardinalis. Brilliant scarlet; hardy. 3 ft. .	.25
5265	grandiflora. Flowers double the size of the old sorts; hardy. 3 ft.25
5267	Blue Wings. A splendid dwarf blue variety; large flowers.25
5270	Crystal Palace compacta. Extra select dark blue; fine for edgings. . . ¼ oz. \$1.00	.15
5275	gracilis. Spreading habit, with bright blue flowers; suitable for vases, etc. ¼ oz. 75c.	.15
5285	speciosa (Crystal Palace). Spreading habit, with dark blue flowers. ¼ oz. 85c.	.15
5290	White Lady. Compact, large flowered, pure white. ¼ oz. 60c.	.10
5295	ramosa (Erect growing). Rich blue, large flowered, distinct and striking. 9 in. ½ oz. 50c.	.25
5300	alba. Large white. ½ oz. 50c.	.25
5305	Heavenly Blue. Large, clear blue. ½ oz. 50c.	.25
5310	rosea. Large, deep rose. ½ oz. 50c.	.25

No.		Pkt.
5315	LOPHOSPERMUM scandens. Beautiful half-hardy climber, well suited for baskets and vases. Bright pink. 1/2 oz. 60c. \$0.15	
	LUPINUS (Lupins). Old-fashioned and well-known annuals, very free growing, with long spikes of bright colored, pea-shaped flowers, and useful in a cut state. 2 1/2 to 3 ft.	
5320	crueickshanki. Dark blue; fine. Oz. 50c. 10	
5325	hartwegi albus. White. Oz. \$1.00 10	
5330	coelestinus. Azure-blue. Oz. 1.00 10	
5335	nigrescens. Clear rich blue. Oz. 1.00 10	
5340	roseus. Fine rose pink. Oz. 1.00 10	
5345	mutabilis. White, sweet-scented. Oz. 50c. 10	
5350	roseus hybridus. Bright rose-pink. Oz. \$1.50 15	
5355	Mixed Annual Sorts. All colors. Oz. 50c. 10	
	LUPINUS (Lupines). Perennial Varieties. Handsome hardy perennials, with immense spikes of pea-shaped flowers. 3 ft.	
5360	polyphyllus, Blue. Oz. 75c. 10	
5363	Lavender Queen. 15	
5365	moerheimi. Rose and white. Oz. \$2.50 25	
5370	roseus. Pink shades. Oz. \$1.50 15	
5375	White. Oz. 75c. 10	
5380	Mixed. Oz. 75c. 10	
5385	Excelsior Mixed. New shades. Oz. \$1.25 15	
	LYCHNIS. Hardy perennials, with large terminal trusses of very showy flowers, excellent for massing. 1 1/2 to 2 ft.	
5390	chalcidonica. Brilliant scarlet. 1/4 oz. 50c. 10	
5395	alba. White. 1/4 oz. 50c. 10	
5400	viscaria splendens. Deep red. 1/4 oz. 50c. 10	
5405	haageana hybrida. Large flowers in brilliant colors. 1/4 oz. 85c. 15	
5410	LYTHRUM roseum superbum. Vigorous perennial, with spikes of bright rose-colored flowers through Summer and Autumn. 3 ft. 15	

No.		Pkt.
	MALOPE. Free blooming, hardy annuals, with large, handsome, mallow-like flowers; suitable for mixed borders and fine for cutting. July to Oct. 3 ft.	
5415	grandiflora alba. White. Oz. 50c. \$0.10	
5420	grandiflora rosea. Rose-pink. Oz. 50c. 10	
	MALVA or MALLOW. Free flowering, hardy perennials, highly decorative for borders, and excellent for cutting; sown early, will bloom first season.	
5425	alcea. Pink; blooms all Summer. 1/4 oz. 85c. 15	
5430	moschata (Muskmallow). Clusters of fragrant rose-colored flowers. 1/4 oz. 50c. 10	
5435	alba. White, fragrant flowers. 2 1/2 ft. 1/4 oz. 50c. 10	
5440	crispa (Curled Mallow). Ornamental foliage, with curled and frilled edges. Annual. 4 ft. 1/4 oz. 50c. 10	
	MARIGOLD, Double African. Handsome hardy annuals, with rich and showy flowers throughout the season; making a gorgeous display in the Autumn. 3 ft.	
5445	Grey's Selected Orange Prince 25	
5450	Grey's Selected Lemon Queen 25	
	Above two sorts specially grown for us by a Scotch specialist and are without an equal.	
5455	Collection of 6 varieties, separate. 50	
5460	Lemon. Extra. 1/4 oz. 40c. 10	
5465	Orange. Extra. 1/4 oz. 40c. 10	
5470	Pride of the Garden. Deep yellow quilled. 1 1/2 ft. 1/4 oz. 40c. 10	
5475	El Dorado Mixture. Finest large-flowered sorts. 1/4 oz. 50c. 15	
5480	Dwarf Mixed. 1 1/2 ft. 1/4 oz. 50c. 10	
	MARIGOLD, French. These are the small velvety flowered sorts.	
5485	Collection of 6 varieties, separate. 50	
5490	Dwarf Gold Striped. Double, 1 ft. 1/4 oz. 50c. 15	
5495	pulchra. Very dwarf, double striped, for edgings. 6 in. 1/4 oz. 50c. 15	
5500	Double Mixed. 1 ft. 1/4 oz. 40c. 10	
5505	Scotch Prize. Special Scotch strain, from double striped prize flowers only. 2 1/2 ft. 1/4 oz. \$2.50 25	
5510	Tall Double Mixed. 2 1/2 ft. 1/4 oz. 50c. 10	
5515	Legion of Honor (Little Brownie). Single golden yellow, with a large spot of crimson velvet. 1 ft. 1/4 oz. 50c. 15	
5520	signata pumila (Tagetes). Single orange yellow. 1 ft. 1/4 oz. 50c. 10	
5525	MATHIOLA bicornis (Night-scented Stock). Recommended for the delightful fragrance given forth toward evening; hardy annual, with purplish-red flowers. 1 ft. 1/4 oz. 50c. 10	
	MATRICARIA (Feverfew). Free flowering annuals, useful for groups, borders and pot culture; also fine for cut flowers. 1 1/2 ft.	
5530	Double White (Grandiflora) 1/8 oz. 75c. 20	
5535	Double Yellow (Golden Ball). Quilled petals. 1/8 oz. 75c. 20	
5540	MAURANDYA, Finest Mixed. Elegant twining plants, with purple, rose and white flowers. Splendid for hanging baskets, window-boxes, etc. They bloom early from seed the first season. Half-hardy perennial. 1/8 oz. 75c. 10	
	MESEMBRYANTHEMUM. Dwarf growing annuals of great beauty; excellent for rockeries, edgings, vases, etc., producing their bright, star-like flowers the whole Summer. In poor soils, with full exposure to the sun, they attain their greatest perfection. 6 in.	
5545	tricolor Mixed. Bright rose, white and purple. 1/4 oz. 50c. 15	
5550	cordifolium variegatum. Handsome, variegated foliage and bright, rose-colored flowers. 25	
	crystallinum. See Ice Plant.	



Marigold, Grey's Selected Orange Prince

No.		Pkt.	No.		Pkt.
	MIGNONETTE (Reseda). The most popular and favorite annual for garden and house culture, producing quantities of deliciously fragrant spikes of flowers. If the plants are thinned out to 6 in. apart, and the tops pinched off when about 2 in. high, stronger plants, with larger spikes of flowers, will be obtained.			MIMULUS . Showy half-hardy annuals, with handsome flowers; excellent for pots or garden.	
5555	Improved Eclipse . The immense, fragrant spikes of flowers 10 to 15 in. long, are produced in the greatest profusion, and is superior to all others for Winter blooming, exhibition or cutting. The seed is all grown under glass from a reselected strain especially for us, and we recommend this as the largest and best. $\frac{1}{8}$ oz. \$2.00	\$0.50	5600	cardinalis grandiflorus . Large, bright scarlet. 2 ft.	\$0.15
5560	Defiance . Very fragrant, large spikes, with individual florets of immense size. $\frac{1}{4}$ oz. 40c., oz. \$1.25	.10	5605	tigrinus grandiflorus . Large-flowered, tigered and spotted varieties. $1\frac{1}{2}$ ft.15
5565	Giant Pyramidal . Large, fragrant spikes of reddish flowers. $\frac{1}{4}$ oz. 25c., oz. 75c.	.10	5610	Musk (Moschatus). Well-known, popular plant, with fragrant yellow flowers and foliage. $\frac{1}{2}$ oz. 85c.	.15
5570	Machet Improved . Dense spikes of very fragrant, dark red flowers; fine for pot culture. $\frac{1}{4}$ oz. 50c., oz. \$1.50	.15	5615	MINA lobata . A rapid growing annual climber bearing profusely racemes of orange-red flowers; prefers a warm situation. $\frac{1}{4}$ oz. 65c.	.15
5575	Machet, Golden . Long, massive spikes with fragrant, golden-yellow flowers. $\frac{1}{4}$ oz. 25c., oz. 75c.	.10		MIRABILIS (Marvel of Peru, or Four-o'clock). Well known annuals, with most brilliant flowers of various colors, suitable for beds or borders. 2 ft.	
5580	Machet, White Pearl . Long spikes of fragrant white flowers. $\frac{1}{4}$ oz. 50c.	.10	5620	Mixed . Brilliant colors. Oz. 35c.	.10
5585	Miles Spiral . Long, fragrant spikes. $\frac{1}{4}$ oz. 20c., oz. 50c.	.10	5625	Variegated Foliage, Mixed . All colors, with green and white leaves. Oz. 35c.	.10
5590	odorata . The old-fashioned common sweet-scented sort. Oz. 35c., $\frac{1}{4}$ lb. \$1.00	.10		MOMORDICA . Ornamental, climbing annual, with handsome fruit which, when ripe bursts open, exposing its bright red seeds and carmine interior.	
5595	MIMOSA pudica (Sensitiveplant). A tender annual of light and elegant growth, the leaflets of which fold up when touched; the pale, purplish flowers are produced at the axils of the leaves. 2 ft. $\frac{1}{4}$ oz. 50c.	.10	5630	balsamina (Balsam-apple). Apple-shaped fruit. 10 ft. Oz. 75c.	.10
			5635	charantia (Balsam-pear). Pear-shaped fruit. 10 ft. Oz. 75c.	.10
				MOONFLOWER . See <i>Ipomoea</i> .	
				MORNING GLORY . See <i>Ipomoea purpurea</i> .	
				MOURNING BRIDE . See <i>Scabiosa</i> .	
				MOUNTAIN FRINGE . See <i>Adlumia</i> .	
			5640	MUSA ensete (Abyssinian Banana). A splendid, large-leaved, palm-like plant, suitable for open air in Summer, and producing a striking effect; seedlings attain a very large size the first season; tender perennial. 100 seeds \$2.50	.25
				MUSK PLANT . See <i>Mimulus</i> .	
				MYOSOTIS (Forget-me-not). These beautiful half-hardy perennials bloom the first season and succeed best in moist, shady situations. If sown in frames in July or August, fine plants may be had for Spring blooming. Fine for edging or in beds with Pansies, Daisies, etc.	
			5645	alpestris grandiflora . Large, bright blue clusters. $\frac{1}{4}$ oz. 50c.	.10
			5650	Indigo , or Royal Blue . Rich. $\frac{1}{4}$ oz. \$1.50	.25
			5655	Victoria . Rich, bright blue, of dwarf globular habit. $\frac{1}{4}$ oz. \$1.50	.15
			5660	Victoria rosea . Fine pink. $\frac{1}{4}$ oz. 1.50	.15
			5665	dissitiflora . Rich blue, the earliest to flower and quite distinct. $\frac{1}{4}$ oz. \$1.50	.25
			5670	Perfection . The large and very showy bright blue flowers on long stalks last a long time, and are most suitable for table decoration at Christmas. Sow in June for Winter blooming. The finest of all. $\frac{1}{4}$ oz. \$1.75	.25
			5675	palustris semperflorens (True Forget-me-not). Large, azure blue flowers from Spring until Autumn. $\frac{1}{4}$ oz. \$2.00	.25
			5680	Ruth Fischer . Azure blue. The largest flowered variety.25
			5685	stricta grandiflora . Upright pillar-like habit; bright blue; very striking. $\frac{1}{4}$ oz. 75c.	.15
			5690	Special Mixture . All colors. $\frac{1}{4}$ oz. 50c.	.10



Machet Mignonette

No.		Pkt.
	NASTURTIUM, Dwarf, or Tom Thumb varieties. Splendid for marginal lines to borders and indispensable Summer bedding plants. They succeed best and flower better in poor soil and remain longer in bloom than perhaps any other annual. 1 ft.	
	Oz. 25c., ¼ lb. 75c., lb. \$2.50, unless priced.	
5695	Collection of 12 colors. Our selection.....	\$1.00
5700	Columbia Mixture. Our own mixture which we make up from separate and distinct sorts; is without an equal.....	.10
5705	Aurora. Primrose, striped with carmine.....	.10
5710	Bronze. Bronzy orange.....	.10
5715	Beauty. Light scarlet.....	.10
5720	Chameleon. Straw color, flaked and veined red.....	.10
5725	coerulea rosea. Rose, blue tinge.....	.10
5730	Crystal Palace Gem. Buff, spotted.....	.10
5735	Dark Crimson. Fine, deep color.....	.10
5740	Empress of India. Deep, brilliant crimson, dark foliage.....	.10
5745	Golden King. Rich, golden yellow.....	.10
5750	King Theodore. Maroon, dark foliage.....	.10
5755	King of Tom Thumb. Rich scarlet, dark foliage.....	.10
5760	Lady Bird. Yellow, barred with ruby.....	.10
5765	Pearl. Pearly white.....	.10
5770	Prince Henry. Yellow, scarlet spots.....	.10
5775	Rose. Soft carmine rose.....	.10
5780	Ruby King. Rich ruby red, dark foliage.....	.10
5785	Scarlet. Very brilliant.....	.10
5790	Spotted King. Yellow, spotted maroon, dark foliage.....	.10
5795	Vesuvius. Brilliant salmon-pink, dark foliage.....	.10
5800	Ivy-leaved, Mixed. Ivy-like foliage and attractive fringed flowers.....	.10
	Oz. 25c., ¼ lb. 75c.	
5805	Variegated-leaved, Mixed. Beautifully variegated foliage.....	.10
	Oz. 25c., ¼ lb. 75c.	
5810	NASTURTIUM lilliput, Finest Mixed. A distinct and fine flowering class, with its small, compact bushes and immense numbers of small blooms displayed well above the foliage.....	.10
	Oz. 35c.	
	NASTURTIUM, Tall or Running Varieties. These are the large free flowering climbers for verandas, trellises and covering unsightly places. Seed pods picked when green and tender are used for pickling.	
	Oz. 25c., ¼ lb. 75c., lb. \$2.25, unless priced.	
5815	Collection of 12 colors. Our selection.....	1.00
5820	Columbia Mixture. Our own mixture, which we make up from separate and distinct sorts is without an equal.....	.10
5821	Black Prince10
5825	Bright Rose10
5830	Chameleon. Varying in color.....	.10
5835	coccineum. Bright scarlet.....	.10
5840	Dark Crimson10
5845	Dunnett's Orange. Orange-red.....	.10
5850	Edward Otto. Brownish lilac.....	.10
5855	Fashion. Pure ecrú, veined with old rose.....	.10
5858	Gold Garnet. Orange yellow, spotted garnet.....	.10
5865	King Theodore. Very deep maroon.....	.10
5870	luteum. Fine yellow.....	.10
5875	Moonlight. Giant pale straw.....	.10
5880	Pearl. Almost white.....	.10
5885	regelianum. Violet ruby.....	.10
5892	Shillingi. Yellow spotted maroon.....	.10
5895	Sunlight. Giant, rich golden.....	.10
5900	Twilight. Light salmon, suffused with rosy salmon.....	.10

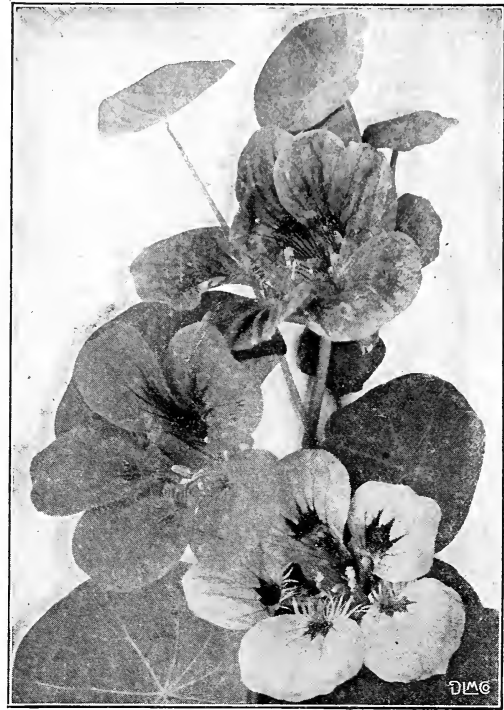

Nasturtiums

No.		Pkt.
	NASTURTIUMS, Tall—Continued	
5905	Vesuvius. Rich apricot, dark foliage.....	\$0.10
5910	Von Moltke. Dark rose.....	.10
5915	Ivy-leaved, Mixed. Ivy-like foliage and fringed flowers in variety.....	.10
	Oz. 25c., ¼ lb. 75c.	
5920	Variegated-leaved, Mixed. An exceedingly fine acquisition.....	.10
	Oz. 25c., ¼ lb. 75c.	
	NASTURTIUM, lobbianum Varieties. These differ from the tall Nasturtiums, in being more free flowering, richer and brighter in color, and with darker foliage, and are superior for house or conservatory, also vases, baskets, etc. Are a mass of color from early Summer until frost.	
5925	Asa Gray. Almost white.....	.10
5930	Black Prince. Velvety black.....	.10
5935	Brilliant. Dazzling scarlet.....	.10
5940	Cardinal. Dark cardinal red.....	.10
5945	Crown Prince. Deep blood red.....	.10
5950	Golden Queen. Clear golden.....	.10
5955	Margaret. Straw, crimson spot.....	.10
5962	Miss Eva Middleton. Fawn color.....	.10
	Oz. 30c.	
5965	Napoleon III. Golden brown spot.....	.10
	Oz. 25c.	
5970	Primrose. Cream brown spots.....	.10
5975	Regina. Beautiful salmon.....	.10
5980	Rudolf Virchow. Ruby rose.....	.10
5985	Spitfire. Bright scarlet; splendid.....	.10
5990	Mixed. All colors.....	.10
	Oz. 20c., ¼ lb. 60c.	
5995	Madam Gunther Hybrids. Dark foliage hybrids.....	.10
	Oz. 25c.	

No.		Pkt.
6000	NEMESIA suttoni. A most valuable, long-blooming annual.....	\$0.25
6001	Blue Gem25
6002	Fire King25
6003	Orange Prince25
6004	White Gem25
	NEMOPHILA. Splendid, showy, hardy annual for beds or edgings, blooming all Summer; also beautiful decorative plants in pots for Spring flowering in house or conservatory. 1 ft.	
6005	insignis. Bright blue, white center.....	1/4 oz. 20c. .10
6010	Mixed. All shades.....	1/4 oz. 20c. .10



Pansy, Grey's Prize Exhibition Strain

No.		Pkt.
	NICOTIANA. Very effective annuals; in bloom throughout the season, and produce their fragrant, tubular-shaped flowers in great profusion; excellent for cutting.	
6015	affinis. White; fragrant, 3 ft.....	1/4 oz. 35c. \$0.10
6020	Choice Hybrids. A great variety of bright colors; fragrant.....	1/4 oz. 60c. .10
6025	colossea. Giant foliage plant of a dark glossy green, with reddish ribs. 5 to 6 ft..	.25
6030	sanderae. Brilliant carmine red.....	1/4 oz. 50c. .10
6035	sylvestris. Pure white. 4 ft.....	1/4 oz. 50c. .10
	NIEREMBERGIA. Graceful, half-hardy perennials of slender growth, blooming profusely the whole Summer; fine for vases, baskets, etc.	
6040	frutescens. White and blue.....	.15
6045	gracilis. White and purple.....	.15

No.		Pkt.
	NIGELLA (Love-in-a-mist). Interesting and free flowering, half-hardy annuals, with elegant cut foliage and curious flowers, of easy culture. 1 1/2 ft.	
6050	Miss Jekyll. Beautiful long-stemmed variety, bright Cornflower blue.....	1/4 oz. 50c. \$0.10
6052	Miss Jekyll. White.....	1/4 oz. 60c. .15
6055	Mixed. Shades of blue and white.....	Oz. 35c. .10
6060	NYCTERINIA, Finest Mixed. Large heads of sweet-scented, star-shaped flowers, produced throughout the whole season; hardy annual.....	1/4 oz. 50c. .10
	OENOTHERA (Evening-primrose). A magnificent class of hardy plants, with large showy blossoms, preferring a light, sandy soil, and warm, sunny situations; July to October. 2 to 3 ft.	
6065	fraseri. Large, deep yellow; fine.....	1/4 oz. \$1.25 .15
6070	lamarkiana. Extra large yellow.....	1/4 oz. 50c. .10
6073	odorata. Yellow, fragrant.....	1/4 oz. 40c. .10
6075	speciosa rosea. Fine rose color.....	1/4 oz. 75c. .25
6085	Annual Varieties, Mixed	1/4 oz. 25c. .10
6090	OXALIS tropaeoloides. Fast growing, hardy annual, with dark bronze foliage and deep yellow flowers, best suited to edgings, rockwork, vases, etc. 6 in.....	1/4 oz. 85c. .15
	PANSY. Too much importance cannot be attached to the culture of these beautiful plants. For early Spring blooming the seed should be sown in July or August and the plants protected during Winter. Early Spring sown seed will give fine blooms during Summer and Fall. A good, cool, rich soil is essential. Rotted cow manure is the best fertilizer for them, and one cannot use too much of it. No fertilizer of a heating nature should be used; give plenty of water through dry weather. You cannot grow good Pansies under trees.	
6095	Grey's Prize Exhibition Strain. This splendid mixture represents the highest perfection of large flowering, new high colored sorts; their brilliancy and richness are most striking.....	1/8 oz. \$2.50, 1/4 oz. \$4.00 .50
6100	Grey's Special Mixture. A grand mixture of the finest varieties, and one of the richest ever sent out; very striking and recommended for market growing.....	1/4 oz. \$2.00, oz. \$7.00 .25
6105	Bugnot's Superb Blotched. Very beautiful class of large flowers with broad blotches. Many of the upper petals are finely lined or veined; great diversity of the handsomest and rarest colors.....	1/4 oz. \$2.00 .25
6110	Cassier's Giant Odier. A strain of great excellence, producing very large, rich and showy flowers.....	1/4 oz. \$2.00 .25
6115	colossea venosa. Giant, round flowers in light, veined shades.....	1/8 oz. \$2.00 .50
6120	English Show. Selected compact strain of the finest large flowering sorts in splendid colors.....	1/4 oz. \$2.50 .25
6125	Giant Trimardeau. Very showy and vigorous class; flowers of fine colors and enormous size.....	1/4 oz. \$1.50, oz. \$5.00 .15
6130	Large Stained Parisian. Splendid mixture of very large flowers, in which white and yellow shades, with clearly defined eye, predominate.....	1/4 oz. \$1.25 .15
6135	Masterpiece. Frilled edged, giant flowers of the richest colors.....	1/4 oz. \$3.00 .25
6140	Matchless. English exhibition strain of immense size and substance in matchless variety of exquisite shades and art colors.....	1/8 oz. \$3.00 .50

PANSY—Continued

No.		Pkt.
6145	Non Plus Ultra. Large size and finest colors. ¼ oz. \$1.75, oz. \$6.00	\$0.25
6150	Superior Quality Mixed (Butterfly). A splendid strain.....	¼ oz. 75c., oz. \$2.50 .10
PANSY, Giant, in Separate Colors.		
6155	Collection of 6 Colors. Our selection.....	1.20
6160	Adonis. Light blue; beautiful.....	¼ oz. \$1.50 .25
6165	atropurpurea. Dark blue.....	¼ oz. 1.50 .25
6170	Brown Shades. With black eye.....	¼ oz. 1.50 .25
6175	Cornflower Blue. One of the finest dark blues.....	¼ oz. \$1.50 .25
6180	Fire King. Crimson, yellow edge.....	¼ oz. 1.50 .25
6185	Golden Queen. Pure yellow.....	¼ oz. 1.50 .25
6190	Golden Yellow. Dark eye.....	¼ oz. 1.50 .25
6195	hortensia Red. Beautiful, soft pink.....	¼ oz. \$1.50 .25
6200	King of the Blacks. Velvety.....	¼ oz. 1.50 .25
6205	Lord Beaconsfield. Violet, top petals shading off to white.....	¼ oz. \$1.50 .25
6210	Mme. Perret. Mostly rose, ruby and crimson shades on white ground.....	¼ oz. \$1.50 .25
6215	Peacock. Peacock-blue, white edge.....	¼ oz. \$1.50 .25
6220	Psyche. Velvety violet, bordered with white; waved petals.....	¼ oz. \$1.50 .25
6225	Ruby King. Extensive range of color from orange scarlet to pink.....	¼ oz. \$1.50 .25
6230	Silver-edged. Purple, white edge.....	¼ oz. 1.50 .25
6235	Snow Queen. Pure white.....	¼ oz. 1.50 .25
6240	Striped. Extra fine.....	¼ oz. 1.50 .25
6245	Violet. Fine violet blue.....	¼ oz. 1.50 .25
6250	Vulcan. Brilliant, dark red, with five large, black spots; frilled edges.....	¼ oz. \$2.50 .25
6255	White. Pure white, violet eye.....	¼ oz. 1.50 .25
TUFTED PANSIES. See <i>Viola cornuta</i> .		
6260	PASSIFLORA caerulea (Passionflower). Fast growing and free flowering, ornamental perennial climbers, with large, showy blue flowers, suitable for conservatory or outside in Summer.....	¼ oz. 85c. .15

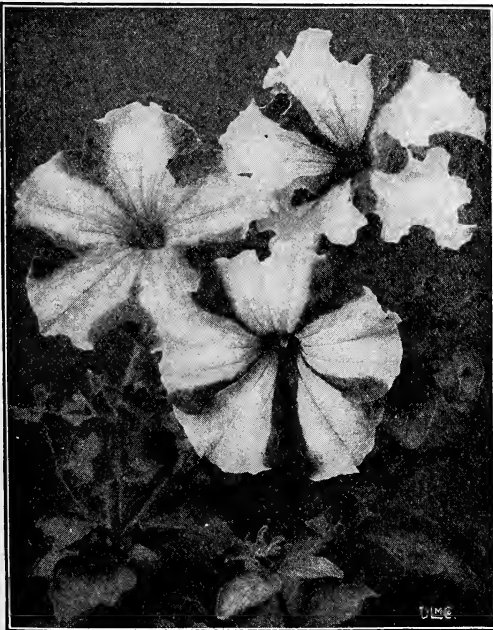

Petunias, Striped

No.		Pkt.
PELARGONIUM. See <i>Geranium</i> .		
PENTSTEMON. Valuable class of perennials, but are best treated as annuals. Seed sown in February or March will make a fine display the same season. The beautiful tubular, Gloxinia-like flowers are freely produced in almost every shade. 2 to 3 ft.		
6264	GRANDIFLORUM EXCELSIOR MIXED. Large flowers; colors range from white to deepest scarlet.....	.25
6265	Giant-flowering Hybrids. Superb strain saved from the finest large-flowered sorts; many new and rich colors.....	1/8 oz. \$1.00 .25
6275	Digitalis. Pure white, with violet spotted throat.....	¼ oz. 75c. .10
6280	hartwegi albus. Numerous spikes of large, pure white flowers.....	.25
6285	murrayanus grandiflorus. Large, bright scarlet.....	1/8 oz. 75c. .25
6290	speciosus. Extra deep blue.....	1/8 oz. 50c. .10
PERENNIAL PEA. See <i>Lathyrus</i> .		
6295	PERILLA atropurpurea laciniata. Dark bronzy purple fringed foliage; very ornamental hardy annual. 2 ft.....	¼ oz. 35c. .10
PETUNIA. An exceedingly attractive and favorite hardy annual for both indoor and outdoor cultivation; when not in too rich soil they will flower most profusely through the Summer. For borders, vases and baskets as well as for pot culture, they are strongly recommended. 1 to 1½ ft.		
6304	Dwarf Rose. Fine, bright color. 6 in.....	¼ oz. \$1.00 .15
6305	Dwarf Striped. Beautiful. 6 in.....	¼ oz. \$1.25 .15
6310	Dwarf Pure White. Satiny white.....	¼ oz. 1.00 .15
6315	Howard's Star. Rich, dark crimson, with five-pointed white star.....	¼ oz. \$1.25 .15
6317	Rose of Heaven. A very dwarf, brilliant rose-pink variety.....	1/8 oz. 40c. .20
6325	Rosy Morn. Lovely, bright pink.....	¼ oz. \$1.50 .15
6327	Violet Blue.50
6330	White. Pure white, free bloomer.....	¼ oz. 60c. .10
6335	Striped and Blotched. Excellent strain with flowers beautifully striped and blotched. ¼ oz. 50c., oz. \$1.50 .10	
6340	Splendid Mixed. Rich colors, superb strain. ¼ oz. 65c., oz. \$2.00 .10	
grandiflora or Large-flowering Sorts. These excellent sorts have extremely large flowers of the richest colors, and are of fine form and substance. The quality is unsurpassed, and we recommend them very highly.		
6350	Fringed Perfection. Immense, deeply fringed flowers; exquisite colors.....	.25
6355	Superb California Giants. The flowers of this re-selected strain are deep throated and very large, of great excellent and variety of colors.....	.25
6360	Superb Ruffled Giants. A California strain of extraordinary size and colors, with deeply ruffled or fluted edges.....	.50
6365	Snowstorm. Immense ruffled and fringed snow-white flowers.....	.25
6367	The Rainbow. Of finest rainbow colorings, with intense yellow throats.....	.25
Double Large-flowering Sorts. Seed saved from the most carefully hybridized flowers. The weaker seedlings should be carefully saved, as these invariably produce the finest double flowers.		
6370	Fringed, Grey's Select. One of the finest strains in existence. The double flowers are very large, full and beautifully formed, having the edges of the petals elegantly fringed; finest colors.....	.50
6375	grandiflora Mixed. Choice strain of fine colors and large flowers.....	.25

- | No. | | Pkt. |
|------|--|--------|
| 6380 | PHACELIA campanularia. Beautiful annual with rich, deep blue, bell-shaped flowers; blooms in about eight weeks from seed.
¼ ft. ¼ oz. 35c. | \$0.10 |
| | PHLOX drummondii. These beautiful, hardy annuals continue in bloom the whole of the Summer, and for bedding or massing nothing can surpass them for brilliancy and richness of color or profusion of flowers. 1 to 1½ ft. | |
| 6385 | grandiflora collection of 6 colors, separate | .50 |
| 6390 | Finest Mixed. An improved strain, with very large flowers and trusses; in brilliant colors. ¼ oz. 85c. | .10 |
| 6395 | Brilliant Scarlet. ¼ oz. 85c. | .10 |
| 6400 | Crimson. White star center. ¼ oz. 85c. | .10 |
| 6405 | Deep Blood Red. ¼ oz. 85c. | .10 |
| 6410 | Pink. Fine shade. ¼ oz. 85c. | .10 |
| 6415 | Pure White. ¼ oz. 85c. | .10 |
| 6417 | Salmon Pink. ¼ oz. 85c. | .25 |
| 6420 | Yellow. ¼ oz. 85c. | .10 |
| 6425 | cuspidata, Finest Mixed. Beautiful star-shaped flowers in showy colors. ¼ oz. 50c. | .10 |
| 6430 | Dwarf, Extra Mixed. An excellent, compact strain for pot culture or edgings, blooming early throughout the season, finest colors. 6 in. ¼ oz. 75c. | .15 |
| 6433 | Apricot. ¼ oz. \$1.00 | .15 |
| 6435 | Bright Scarlet. ¼ oz. 1.00 | .15 |
| 6440 | Daybreak Pink. ¼ oz. 1.00 | .15 |
| 6445 | Pure White. ¼ oz. 1.00 | .15 |
| 6446 | Yellow. ¼ oz. 1.00 | .15 |
| 6455 | PHLOX decussata, Newest Hybrids. Tall growing, perfectly hardy plants, with immense trusses of large and beautiful flowers in the greatest range of colors. 3 to 4 ft.
¼ oz. \$1.25 | .25 |



Phlox drummondii

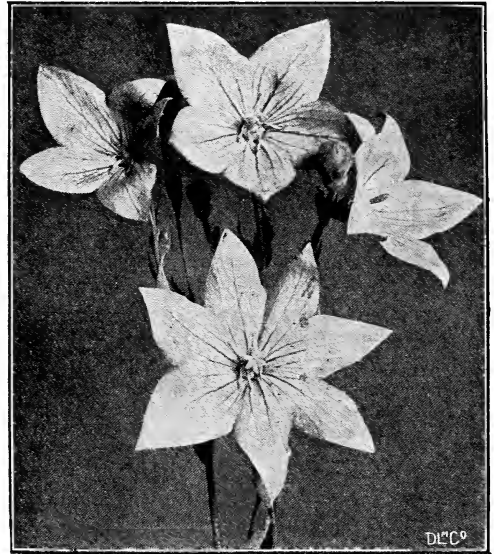

Platycodon

- | No. | | Pkt. |
|------|---|--------|
| 6460 | PHORMIUM tenax foliis variegatis (New Zealand Flax). Handsome, decorative plant for greenhouse or garden. The rigid, erect leaves are often 6 ft. in length, narrow dark green, striped with rich yellow and white. The spikes of orange colored flowers are 8 to 12 ft. high. \$0.25 | \$0.25 |
| 6465 | PHYSALIS francheti (Japanese Wintercherry). Hardy perennial, treated as an annual, fruiting first season from seed. A Japanese variety of the Groundcherry, with edible fruit in large, brilliant red capsules, which retain their color for months; fine for Winter decoration. 2 ft. ¼ oz. 50c. | .15 |
| 6470 | PHYSOSTEGIA virginica (Texas Heath). Fine hardy perennial, resembling a giant heather, with beautiful pink flowers through the Summer; fine for cutting. 2 ft. ¼ oz. 75c. | .15 |
| 6475 | virginica alba. Large white. ¼ oz. \$1.00 | .15 |
| | PINKS. See Dianthus. | |
| 6480 | PLATYCODON grandiflora. Handsome hardy perennial, with large, deep blue, bell-shaped flowers, from June to Oct.; allied to the Campanula. 2 ft. ¼ oz. \$1.00 | .10 |
| 6485 | grandiflora alba. Large white. ¼ oz. \$1.00 | .10 |
| 6490 | mariesi. Dwarf, compact sort, with rich blue flowers. 1 ft. ¼ oz. \$1.25 | .15 |
| 6495 | POLEMONIUM caeruleum, Mixed (Jacobsladder). Fine hardy perennials with large heads of showy flowers, easily grown in any good garden soil. May to August. 2 ft. ¼ oz. \$1.00 | .15 |
| | POPPIES, Single Annual Varieties. For hardiness and easy culture these showy plants cannot be surpassed. They are very free flowering and make a gorgeous display. | |
| 6500 | Admiral. Large, single, white, with a broad edge of bright scarlet. Oz. \$1.25 | .10 |
| 6505 | Danebrog. Single scarlet, with white blotch on each petal. Oz. 75c. | .10 |
| 6510 | English Scarlet. The common scarlet field Poppy. Oz. \$1.25 | .15 |
| 6515 | glaucom (Tulip Poppy). Vivid scarlet. 1 ft. ¼ oz. 25c. | .10 |

POPPIES, Single Annual—Continued

No.		Pkt
6520	Shirley, Extra Selected. A much improved strain, with flowers of large size and from the most distinct and charming colors of this lovely race of single Poppies. The flowers are of a shining silky texture, and the bright, delicate colors in the greatest variety possible are to be had in this strain. 2 ft. Oz. \$1.25, ¼ lb. \$4.00	\$0.10
6525	Salmon Shades. Novel and effective tints. ¼ oz. 75c.	.15
6530	The Bride. Beautiful, large, pure white. 2 ft. Oz. 60c.	.10
6535	umbrosum. Rich vermilion, with black spot at base of each petal. 1½ ft. Oz. \$1.00	.10
6540	Collection of 6 Single Varieties. Our selection.50

POPPIES, Double Annual Varieties.

6545	American Flag. Large, snow white, fringed flowers, bordered with scarlet. 2 ft. Oz. 75c.	.10
6550	Cardinal Hybrids. Semi-dwarf, beautiful class, with large flowers in richest and brightest colors. 1½ ft. ¼ oz. 30c.	.10
6555	Carnation-flowered Mixed. Large, showy fringed flowers in choice colors. Oz. 75c.	.10
6560	Japanese Pompon, Mixed. Beautiful, small double flowers in finest colors. 1 ft. ¼ oz. 50c.	.15
6565	Milkado. Double white-fringed petals tipped with crimson. 2 ft. Oz. 75c.	.10
6570	Paeony-flowered Mixed. Immense globular flowers, resembling the Paeony; in choice colors. 2 ft. Oz. 75c.	.10
6575	Pink. Immense bright pink. Oz. 85c.	.10
6580	Scarlet. Immense flowers. Oz. 85c.	.10
6585	White. Immense, pure white. Oz. 85c.	.10
6590	Yellow. Immense, clear yellow. Oz. 85c.	.10
6596	salmonium. Double Shirley in all salmon shades from the most delicate to the most brilliant salmon orange.15
6600	White Swan. Dwarf white. 1 ft. ¼ oz. 35c.	.10
6605	Collection of 6 Double Varieties. Our selection.50

POPPIES, Hardy Perennial Varieties.

6610	Alpine, Mixed. Pretty, dwarf free flowering sorts, in delicate colors. ½ ft.15
6615	nudicaule, Single, Mixed (Iceland Poppy). Beautiful border plant with bright, delicate colors, and if sown early will bloom the first year. 1 ft. ¼ oz. \$1.25	.20
6620	Bright Yellow. ¼ oz. 1.00	.25
6625	Orange Scarlet. ¼ oz. 1.00	.25
6630	Pure White. ¼ oz. 1.00	.25
6635	Double Mixed. All colors. ¼ oz. 1.00	.25
6640	orientale. Very large, brilliant scarlet with black blotch. 3 ft. ¼ oz. 60c.	.10
6645	Blush Queen. Large pale pink. ½ oz. 50c.	.15
6650	Livermere. Large, deep crimson. ½ oz. 75c.	.25
6655	Queen Alexandra. Bright rosy salmon.15
6660	Royal Scarlet. Immense blooms. ½ oz. 50c.	.15
6665	Salmon Queen. Salmon yellow. ½ oz. 50c.	.15
6670	White. New large white.25
6675	Hybrids. Many choice shades. ¼ oz. \$1.00	.15

PORTULACA. One of our finest hardy annuals specially adapted to light soils, dry, sunny situations and exposed rockeries. The rich and brilliant colored flowers are produced in the greatest profusion during the hottest weather. 6 in.

6680	Double-flowered, Mixed. Perfectly double flowers in brilliant and striking colors. ¼ oz. \$1.25	.15
------	---	-----

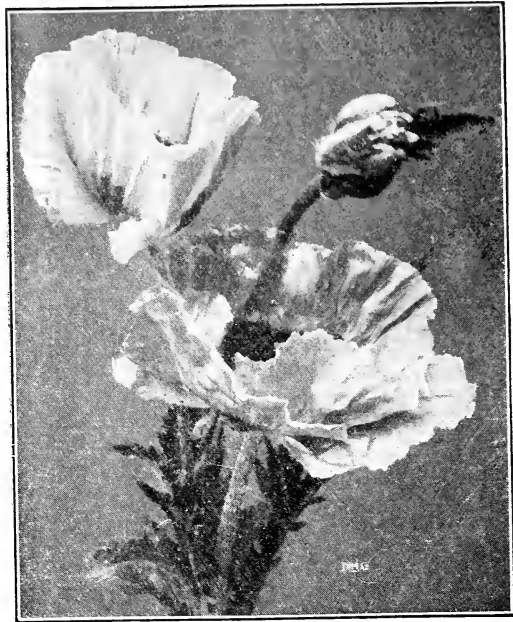

Oriental Poppies

PORTULACA—Continued

No.		Pkt.
6685	Single-flowered, Mixed. Large flowers in most brilliant colors. ¼ oz. 40c., oz. \$1.25	\$0.10
6690	Rose. ¼ oz. 50c., oz. 1.50	.10
6695	Scarlet. ¼ oz. 50c., oz. 1.50	.10
6700	White. ¼ oz. 50c., oz. 1.50	.10
6705	Yellow. ¼ oz. 50c., oz. 1.50	.10
6710	Collection of 4 colors, separate.35
	POTENTILLA. A showy class of hardy perennials, producing in great abundance rich colored flowers of velvety texture; July to October. 1½ to 2 ft.	
6715	Double Hybrids, Mixed. ¼ oz. \$1.00	.25
6720	Single Hybrids, Mixed. ¼ oz. 60c.	.15
	PRIMULA or PRIMROSE. Hardy and half-hardy sorts. The following Primulas are exceedingly charming and useful plants for growing under glass or in the open air. Most of the hardy sorts require, in our climate, protection during Winter.	
6725	auricula. Saved from a large and varied collection of choice colors.25
6730	Garden Primrose, New Hybrids (Acaulis). An excellent, large-flowering strain of bright colors. ½ oz. \$3.00	.25
6735	Blue. Clear blue color.25
6740	Yellow. English primrose. ½ oz. \$1.25	.25
6745	polyanthus, Giant Mixed. New large flowering strain of the brightest colors.25
6750	Finest Fancy Mixed. Extra choice strain.	.15
6755	Gold Laced. Showy and attractive yellow edged sorts.15
	PRIMULA chinensis (Chinese Primrose). All our chinensis and stellata Primroses are grown for us by an English specialist who grows nothing but Primulas, and our strains of these were among the best exhibited for the last two seasons. For excellence in every point they cannot be equalled.	
6760	Grey's Giant Mixture. A grand mixture of giant Primroses.	1.00
6765	Half packet of Giant Mixture.50

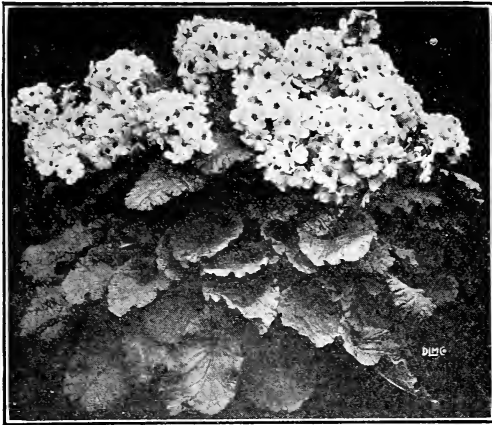

Primula obconica

No.		Pkt.
	PRIMULA chinensis —Continued	
6770	Grey's Giant White. The largest and best white ever sent out; flowers of great substance.....	\$1.00
6775	Grey's Giant Pink. The finest and largest bright pink; petals extremely large and of great substance.....	1.00
6780	Grey's Giant Crimson. Most lovely rich velvety crimson, fine habit, good substance and very free flowering.....	1.00
6785	Grey's Giant Salmon. A distinct and valuable sort with massive trusses of salmon-pink flowers well above the foliage.....	1.00
6790	Grey's Giant True Blue. Beautiful fringed blossoms of immense size, fine substance and freely produced; the best blue.....	1.00
6795	Grey's Orange King. A grand new sort, said to be an entirely new color in Primulas, a beautiful orange color in bud and when open of a terra cotta color shaded with orange-salmon around the edge; very large and free.....	1.00
6800	Giant Art Shade. One of the most lovely yet introduced. The immense blooms are fringed and curved; the color is an art shade of an intense fiery glare.....	1.00
6805	Giant Brilliant King. Large and erect blooms, forming a pyramid of beautiful rich crimson flowers; superb sort.....	.75
6810	Giant Chiswick Red. Improved strain, with large beautifully fringed crimson-scarlet flowers.....	.75
6815	Giant Crimson King. The large deep rich crimson bloom with a dark brown eye make it one of the most brilliant and effective....	.75
6820	Giant Covent Garden White, Improved. Flowers very large, white and beautifully fringed; a very free flowering improved strain.....	.75
6825	Giant Delicata. Free flowering beautiful soft pink, with very large erect blooms... ..	.75
6830	Giant, His Majesty. Magnificent new sort, with distinct glossy foliage and massive, finely fringed velvety, dark crimson blooms; one of the finest ever raised.....	.75

		Pkt.
	PRIMULA chinensis —Continued	
6835	Giant King George V. (New). The darkest crimson yet offered, of giant size, beautifully fringed, very free flowering and of massive substance.....	\$0.75
6840	Giant Queen Mary (New). One of the finest ever raised, erect, free flowering, of great substance, and of a lovely delicate pink color.....	.75
6845	Giant Ruby Queen. One of the finest of all the deep red sorts; the flowers are large finely fringed, and of an intense rich scarlet with bright yellow eye.....	.75
6850	Giant Duchess. Most distinct and beautiful, having large pure white flowers with a zone of carmine-crimson around a clear yellow eye.....	.75
	PRIMULA stellata, or Star Primrose. This valuable and very distinct variety should be extensively grown for greenhouse and table decoration. The innumerable star-shaped flowers make an effective contrast to the attractive dark foliage.	
6855	Blue Star Improved. A strain of very large dark blue flowers and pale green foliage... ..	.75
6860	Brilliant Rose Star. Bright rose flowers and graceful, dark green fern leaf foliage, which is red underneath.....	.75
6865	Crimson Star. Fine colored sort with large, brilliant, rich crimson flowers.....	.75
6870	King of Star. Deep crimson.....	.75
6875	Salmon Pink Star. Improved strain....	.75
6880	White Star. Improved, large, pure white.75
6885	Mixed Star. A special mixture.....	.75
	PRIMULA obconica. A beautiful and continuous blooming variety with handsome spikes of flowers and pretty foliage. For Winter blooming, seed should be sown in April or May in good porous loam. The grandiflora sorts are the freest blooming, but the individual flowers are not as large as the gigantea type.	
6890	grandiflora alba. Large, pure white.....	.25
6895	carminea. Large, carmine-red.....	.25
6900	hybrida. Finest giant flowered sorts, mixed.....	.50
6905	Giant fimbriata. Giant fringed sorts.....	.50
6910	Apple Blossom. Delicate pink.....	.50
6915	Bright Rose50
6920	lilacina. Dark lilac.....	.50
6925	oculata. Dark-eyed varieties.....	.50
6935	Rich Crimson50
6937	Salmon. A fine shade.....	.50
6940	forbesi (Baby Primrose). This is like the obconica in habit, with showy rosy lilac yellow-eyed flowers, a continuous bloomer and may be had in flower in three months after sowing.....	.25
6945	PRIMULA kewensis. A great acquisition as a Winter flowering decorative plant and excellent for cutting. The flowers are bright yellow, very fragrant, on erect stems 12 to 18 inches long.....	.50
6950	PRIMULA malacoides. Very free flowering species from China and an excellent pot plant for indoor growing; the flowers are $\frac{1}{2}$ to $\frac{3}{4}$ inch across, of a light lilac color and will bloom in four months from seed..	
6955	alba. Pure white.....	.25
6960	rosea. Rose shades.....	.25

No.	Pkt.
PYRETHRUM. Handsome, hardy perennials, indispensable for herbaceous borders or for cutting; they grow best in cool, moist situations. 2 ft.	
6970 Double Hybrids, Mixed. Saved from a choice strain of double and semi-double flowers, in finest colors	1/8 oz. \$3.00 \$0.25
6972 Double Hybrids, Kelways. Saved from their unequalled collection of named sorts.50
6975 Single Hybrids, Mixed. Single Daisy-like flowers in rich colors.	1/4 oz. \$1.75 .15
6976 Single Hybrids, Kelways. Superb large flowering sorts with immense single flowers of richest colorings.	1/8 oz. \$1.25 .25
6985 PYRETHRUM aureum (Golden Feather). Bright golden foliage used extensively for Summer bedding, edgings and ribbon work. Treated as annuals. 3/4 ft.	1/4 oz. 30c. .10
6990 selaginoides. Bright golden, fern-like foliage.	1/4 oz. 60c. .10
6995 RANUNCULUS, Double Mixed French. Beautiful double Buttercup-like flowers in great variety of choice colors; flowering first season from seed; hardy with protection. 3/4 ft.	1/4 oz. 75c. .15
RESEDA. See Mignonette.	
7000 RHODANTHE, Mixed. Handsome pink and white, annual everlasting; excellent for bouquets of dried flowers. 1 ft. 1/4 oz. 30c. .10	
7005 manglesi. Bright pink; beautiful. 1/4 oz. 50c. .15	
RICINUS (Castor-oil-bean). Large, luxuriant, rapid growing foliage plants, with immense palm-like leaves and brilliant colored fruit. In center of beds or singly on lawns, they produce a fine effect; half-hardy annual.	
7010 borboniensis. Large, purplish green leaves. 15 ft.	Oz. 30c. .10
7015 cambodensis. Best dark-leaved sort. 6 ft.	Oz. 40c. .10
7020 gibsoni. Dark purple stems and foliage. 6 ft.	Oz. 35c. .10
7025 gibsoni mirabilis. Dwarf reddish foliage. 4 ft.	Oz. 35c. .10
7030 sanguineus. Red stalks and fruit. 8 ft.	Oz. 30c. .10
7035 zanzibarensis, Mixed. A distinct race with enormous leaves varying in color from pale green to brownish purple.	Oz. 30c. .10
7040 Mixed. All sorts.	Oz. 25c. .10
7045 ROMNEYA coulteri (Giant White California Poppy). A California perennial, with immense, pure white, fragrant flowers, with golden center, blooming continually from June to September; makes a fine pot plant and requires protection in Winter. The seed will sometimes remain dormant for months after planting. 3 ft.15
RUDBECKIA (Cone-flower). Beautiful border plants lasting a long time in bloom and excellent for Summer and Autumn display; each bloom is like a miniature Sunflower. 2 ft.	
7050 bicolor superba. Orange-yellow, with velvety brown center; annual.	1/4 oz. 50c. .10
7055 newmanni. Golden yellow, with velvety maroon center; hardy perennial.15
purpurea. See <i>Echinacea</i> .	
7060 SAINTPUALIA ionantha grandiflora. Charming greenhouse plant, with beautiful deep blue flowers, 1 1/4 inches in diameter, resembling the Violet.25



Pyrethrum

No.	Pkt.
SALPIGLOSSIS, Improved Large Flowering. Very beautiful free flowering annuals in great variety of color. The large, richly colored flowers are elegantly veined, and penciled, blooming from July to frost, and are splendid for cutting. 2 ft.	
7063 Light Blue and Gold. Large. 1/4 oz. \$1.00	\$0.15
7065 Purple, Golden Veined. Large. 1/4 oz. 1.00	.15
7070 Rose, Golden Veined. Large. 1/4 oz. 1.00	.15
7075 Scarlet, Golden Veined. Large. 1/4 oz. 1.00	.15
7080 Large Flowering, Mixed.	1/4 oz. 85c. .15
7085 Emperor, Mixed. A robust class, with only one leading stem covered with immense flowers of richest colors.	1/4 oz. \$1.00 .15
7090 Dwarf, Mixed. New class, 12 to 15 inches high, with larger flowers more freely produced than the tall growing.25
7095 Collection of 4 colors, separate.45
SALVIA. One of our handsopest and most showy Summer and Autumn flowering plants forming compact bushes, which are literally ablaze with brilliant flowers from July to frost.	
7098 America (Globe of Fire).	1/8 oz. \$1.25 .25
7100 farinacea. Remarkable for its long flower spikes of lavender blue. 3 ft.	1/8 oz. \$1.00 .15
7105 patens. Rich blue. 2 ft.	1/8 oz. 1.75 .25
7110 splendens Bonfire. Finest compact sort of very even growth, with dense spikes of vivid dark scarlet flowers. 2 1/2 ft.	1/4 oz. \$1.50 .20
7115 splendens Fireball. Compact sort, with large, scarlet flower spikes, early and rich flowering. 2 ft.	1/4 oz. \$1.75 .20

No. **SALVIA**—Continued

		Pkt.
7120	splendens grandiflora. Large, brilliant scarlet flower spikes. The most popular sort grown. 3 ft.....	¼ oz. \$1.00 \$0.10
7125	splendens liliputana. Compact, globular habit, not over 10 inches high, with vivid scarlet flower spikes freely produced very early.....	.25
7130	splendens Ostrich Plume. The spikes of flowers are like plumes; of the brightest scarlet, and the bush is well covered; each plume is a bouquet in itself.....	.25
7135	Zurich. The very earliest flowering variety; it is of a rich scarlet and suitable for pot growing, as it is very dwarf. 1 ft.....	⅛ oz. \$1.25 .25
7140	SANVITALIA procumbens fl. pl. Pretty free flowering hardy annual, with double flowers of a bright yellow. 9 in.....	¼ oz. 75c. .15

SAPONARIA. A beautiful class of compact growing hardy annuals, with small, starry flowers from July to September; suitable for beds or borders, and fine for cutting.

7145	vaccaria. Profuse blooming, with beautiful pink feathery flowers. 3 ft.....	¼ oz. 20c. .10
7150	vaccaria alba. White flowered; a fine market flower....	¼ oz. 20c. .10



Schizanthus

SCABIOSA, Improved Large-flowering (Mourning Bride). One of our best Summer-flowering annuals. The rich and beautiful colored flowers are very handsome and excellent for cutting; profuse bloomer. June to October. 2½ ft.

7155	Azure Fairy. Delicate mauve... ¼ oz. 50c.	\$0.10
7160	Cherry Red. Bright color... ¼ oz. 50c.	.10
7165	Fiery Scarlet. Brilliant color... ¼ oz. 50c.	.10
7170	King of Blacks. Black purple... ¼ oz. 50c.	.10
7175	Rose Pink. Beautiful shade... ¼ oz. 50c.	.10
7178	Peach Blossom. Peach blossom pink... ¼ oz. 50c.	.25
7180	Purple, Edged White. ¼ oz. 50c.	.10
7185	White. Large pure white... ¼ oz. 50c.	.10
7190	Mixed. All colors... ¼ oz. 50c.	.10
7195	Collection of 6 colors. Our selection.....	.50



Scabiosa

Pkt.

No.

Pkt.

SCABIOSA, Hardy Perennial Varieties. Of great value either in the herbaceous border or for cutting. 2 ft.

7200	caucasia. Beautiful lilac blue. ¼ oz.	\$2.50 \$0.15
7205	Large-flowered Hybrids. New, soft and delicate colors in great variety.....	.25

SCARLET RUNNER. See Bean.

SCIZANTHUS (Butterflyflower). Beautiful and showy, erect growing, hardy annuals for house or garden; 1½ ft.

7210	hybridus grandiflorus. Very fine new large flowered varieties in very effective colors.....	½ oz. 75c. .15
7215	Garraway's Hybrids. A beautiful strain for greenhouse, containing a wide range of colors.....	.50
7220	wisetonensis. Containing the most delicate shades of white, pink, rose and crimson; excellent for pot culture. 1-16 oz.	\$2.00 .25
7225	albus. Glistening snow white; very compact. 16 in.....	.25
7226	Snowflake. Compact pyramidal habit. Pure white frilled edges.....	.25
7230	SCHIZOPETALON walkeri. Hardy annual producing quantities of white, almond-scented flowers, which are elegantly fringed at edges. June to October. 1 ft. ¼ oz.	35c. .15
7235	SEDUM (Stonecrop). Mixed. Suitable for rockwork, edgings and dry situations; their glaucous foliage and bright flowers invariably attract attention; hardy perennial. 4 in.....	½ oz. 85c. .20
7240	coeruleum. Blue flowered annual variety, very useful in borders, etc.....	.25

SENSITIVE PLANT. See Mimosa.

7245	SHAMROCK. True, small leaved variety, resembling a very small leaved clover; imported seed.....	¼ oz. 50c. .10
------	--	----------------

SILENE (Catchfly). Very pretty and profuse blooming plants, with bright and attractive flowers; extremely useful and doing well in any ordinary soil.

7250	armeria, Mixed. Free flowering, hardy annual, with pink, white and red flowers. 1 ft.....	¼ oz. 25c. .10
7255	pendula, Peach Blossom. Beautiful bright pink annual variety for Spring bedding, edgings, etc.....	¼ oz. 35c. .10
7260	orientalis. Fine, hardy perennial with large, globular heads of beautiful pink flowers; blooms from June to August and is fine for cutting; flowers first season from seed. 2½ ft.....	¼ oz. 35c. .10

No.		Pkt.
7265	SMILAX (<i>Myrsiphyllum asparagoides</i>). A climbing plant unsurpassed for its graceful foliage and orange-blossom fragrance of its flowers..... $\frac{1}{4}$ oz. 25c.	\$0.10
7270	Myrtle-leaved. New and distinct form, more graceful than preceding. 100 seeds 75c.	.20

SNAPDRAGON. See Antirrhinum.

7275	SOLANUM capsicastrum nanum (Jerusalem Cherry). Very ornamental plants for house or greenhouse, being almost completely covered with bright scarlet berries. Early Spring sown seed will produce fruiting plants in the Autumn. 1 ft. $\frac{1}{4}$ oz. 50c.	.10
7280	Cleveland. An improved variety of Jerusalem Cherry, with very large, brilliant berries. A fine decorative plant.15
7285	STATICE (Sea-lavender). Mixed. Beautiful hardy perennial.10
7290	latifolia. Deep lavender-blue. $\frac{1}{8}$ oz. 40c.	.10
7291	Sinuata Blue. Annual varieties. $\frac{1}{4}$ oz. 40c.	.15
7292	Sinuata Rose. $\frac{1}{4}$ oz. 40c.	.15
7293	Sinuata White. $\frac{1}{4}$ oz. 40c.	.15

STEVIA. Free flowering greenhouse perennials, with sprays of tiny flowers; extensively grown by florists. They bloom profusely from seed the first season, and are treated as annuals. 2 ft.

7295	eupatoria. Fine pinkish white. $\frac{1}{4}$ oz. 35c.	.10
7300	serrata. Pure white; fragrant	.15

STOCKS (Gilliflower). One of the most highly prized of all our cultivated flowers. The delightful fragrance, free-blooming character and beautiful colors have made them as desirable for Winter cultivation in the greenhouse as for the garden in Summer; invaluable as cut flowers.

LARGE-FLOWERED DOUBLE GIANT PERPETUAL PERFECTION (Cut-and-come-again). An excellent variety of fine branching habit, with large double flowers in great abundance from June till frost. $1\frac{1}{2}$ ft.

7305	Apple Blossom Pink. $\frac{1}{8}$ oz. \$1.25	.15
7310	Bright Rose. $\frac{1}{8}$ oz. 1.25	.15
7315	Canary Yellow. $\frac{1}{8}$ oz. 1.25	.15
7320	Dark Blood Red. $\frac{1}{8}$ oz. 1.25	.15
7325	Dark Blue. $\frac{1}{8}$ oz. 1.25	.15
7330	Light Blue. $\frac{1}{8}$ oz. 1.25	.15
7335	Scarlet. $\frac{1}{8}$ oz. 1.25	.15
7340	Snow White. $\frac{1}{8}$ oz. 1.25	.15
7345	Mixed, Extra. The above and many other colors. $\frac{1}{8}$ oz. 1.25	.15
7350	Collection of 6 colors. Our selection.75

SPECIAL LARGE-FLOWERING PERFECTION OF NICE, TEN-WEEKS. Splendid strain for garden or greenhouse, of fine branching habit, with very large, double fragrant flowers. An unusually long and free blooming strain. 2 ft.

7351	Collection of Six Separate Colors.	1.20
7352	Almond Blossom. Shell pink. $\frac{1}{8}$ oz. \$1.00	.25
7354	Beauty of Naples. Old rose. $\frac{1}{8}$ oz. 1.00	.25
7355	Beauty of Nice. Delicate flesh pink.25
	$\frac{1}{8}$ oz. 1.00	.25
7358	Bianca. Snow white, early. $\frac{1}{8}$ oz. 1.00	.25
7362	Cote d'Azur. Light blue. $\frac{1}{8}$ oz. 1.00	.25
7365	Crimson King. Rich crimson. $\frac{1}{8}$ oz. 1.00	.25
7370	Golden Feather. Yellow. $\frac{1}{8}$ oz. 1.00	.25
7375	Queen Alexandra. Mauve. $\frac{1}{8}$ oz. 1.00	.25
7377	Violet of Nice. Dark violet. $\frac{1}{8}$ oz. 1.00	.25

No.		Pkt.
	MAMMOTH COLUMN TEN-WEEKS. Splendid variety; earliest flowering of the Ten-Weeks Stocks; produces only one spike of large, double flowers. $2\frac{1}{2}$ ft.	
7380	Crimson. $\frac{1}{8}$ oz. \$1.25	\$0.15
7385	Gloria. Blood red; extra. $\frac{1}{8}$ oz. 1.25	.15
7390	Light Blue. $\frac{1}{8}$ oz. 1.25	.15
7395	Rose Pink. $\frac{1}{8}$ oz. 1.25	.15
7400	Snow White. $\frac{1}{8}$ oz. 1.25	.15

DWARF BOUQUET TEN-WEEKS. This is the finest dwarf Stock for growing in pots or for edgings; it is of bushy habit, with beautiful double flowers. 8 in.

7405	Crimson. Fine, deep color. $\frac{1}{8}$ oz. \$1.00	.15
7410	Pure White. Excellent. $\frac{1}{8}$ oz. 1.00	.15
7415	Mixed. All colors. $\frac{1}{8}$ oz. 1.00	.15
7420	STOKESIA cyanea (Cornflower Aster). Beautiful hardy perennial, with lavender-blue blossoms July to frost. 2 ft. $\frac{1}{4}$ oz. \$1.00	.15
7424	cyanea. Mixed.15

7425 **STREPTOCARPUS, Veitch's New Hybrids.** Handsome greenhouse perennial, with Achimene-like flowers in clusters on slender stems. Treatment same as for Gloxinia.

SUNFLOWER. See Helianthus.

SWAINSONA. Fragrant, tender perennial for house or conservatory. Graceful foliage and Sweet Pea-like flowers. Grown as a climber or trimmed into bush form. Usually grown in pots.

7434	grandiflora. Finest Mixed.50
	SWEET CLOVER. Grown for the fragrance of their flowers and foliage.	
7440	melilotus alba. Yellowish white; very fragrant; hardy biennial. 3 ft. Oz. 30c.	.10
7445	coerulea. Blue flowers; very sweet, hardy annual. 2 ft. Oz. 50c.	.10

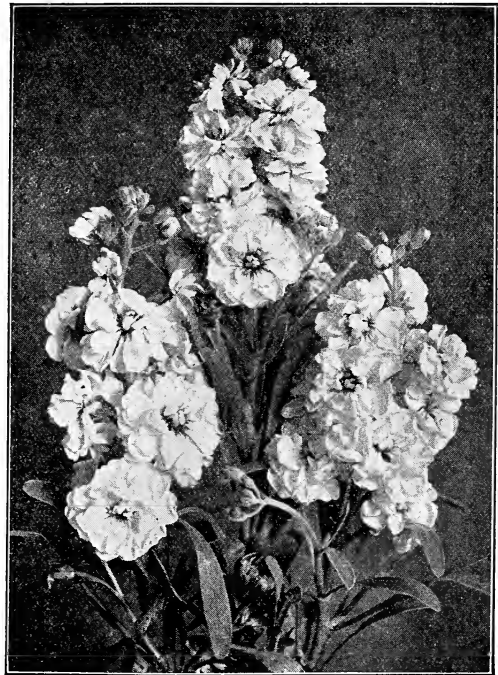

Stocks, Large-flowered Double Ten-Weeks

SWEET PEAS

No.		Pkt.	No.		Pkt.
	GIANT SPENCER or ORCHID FLOWERING. Unquestionably the finest type of this most popular flower that has ever been introduced. The waved flowers are of immense size, usually two inches or more across and with three to five flowers on a stem. The season of bloom is much longer than the old type. Grow 3 to 4 inches apart in the rows. Separate varieties. Oz. 50c., $\frac{1}{4}$ lb. \$1.50 unless otherwise priced.		7482	Anne Ireland. White, with terra cotta pink edge..... Oz. 60c.	\$0.10
7450	Special Exhibition Mixture. This mixture is made up entirely of the Spencer and Unwin types and includes the finest sorts and most effective colors; it is without an equal and cannot fail to give the greatest satisfaction. Oz. 35c., $\frac{1}{4}$ lb. \$1.00, lb. \$3.25.	\$0.10	7490	Aurora. Cream white, flaked with rich orange salmon.....	.10
7455	Afterglow. Electric shades of blue and rosy mauve.....	.10	7492	Austin Frederick. Giant true lavender....	.10
7460	Agricola. Large white, lilac flush.....	.10	7495	Barbara. Large salmon-orange.....	.10
7465	America Spencer. Red flakes on white ground, extra fine.....	.10	7505	Blanche Ferry Spencer. Pink and white.....	.10
7481	Alexander Malcolm. Scarlet-cerise.....	.10	7506	Blue Monarch. Large dark blue.....	.10
			7507	Blue Picotee. Large pure white, violet blue edge.....	.10
			7508	Bunty. Standards orange-salmon, wings deep rose tinged.....	.15
			7510	Captain of the Blues. Wings bright blue, standard purple.....	.10
			7535	Clara Curtis. Primrose.....	.10
			7536	Colne Valley. Lavender-blue self.....	.10
			7537	Commander Godsall. Giant rich violet-blue..... Oz. 60c.	.10
			7539	Constance Hinton. Giant white, B. S....	.10
			7545	Countess Spencer. A rich, pure pink....	.10
			7555	Decorator. Crimson and orange.....	.10
			7560	Dobbies Cream. Rich primrose.....	.10
			7577	Edith Cavell. Rose-pink on cream ground.....	.10
			7590	Edith Taylor. Soft salmon rose.....	.10
			7595	Elfrida Pearson. Giant blush pink, with deeper margin.....	.10
			7600	Elsie Herbert. Large creamy white, pink edge.....	.10
			7615	Etta Dyke (Money Maker). Fine strain of White Spencer.....	.10
			7623	Fiery Cross. Bright red, orange, cerise, or "military red"..... Oz, 60c.	.10
			7635	Florence Nightingale. Bluish lavender. One of the best.....	.10
			7646	Gladys. A lovely shade of pure lilac self, many stems having four flowers.....	.15
			7648	Hawlmak Cerise. True to color.....	.15
			7653	Hawlmak Lavender. A true lavender colored Sweet Pea.....	.10
			7654	Hawlmak Maroon. Rich red maroon.... Oz. 60c.	.10
			7656	Hawlmak Pink. Bright rose pink. Oz. 60c.	.10
			7657	Hawlmak. Salmon-pink.....	.15
			7658	Heavenly Blue. A real Delphinium blue....	.15
			7659	Hebe. Giant rosy pink.....	.10
			7660	Helen Lewis. Rich orange-pink.....	.10
			7665	Hercules. Giant soft rose-pink.....	.10
			7670	Illuminator. Warm salmon-orange, overlaid with rich cerise pink.....	.10
			7678	Jean Ireland. Creamy buff, deep pink edge.....	.10
			7680	King Edward Spencer (Maud Holmes). Deep, rich crimson.....	.10
			7685	King Manoel. Largest, deep maroon.....	.10
			7690	King White. Giant, pure white.....	.10
			7691	Lavender, George Herbert (Dobbies). Large flowered lavender.....	.10
			7692	Lord Lascelles. Extra fine lavender.....	.25
			7700	Loyalty. Violet-blue flake on white ground.....	.10
			7705	Marie Corelli. Brilliant rose.....	.10
			7715	Margaret Atlee. Salmon-pink or cream. A new shade of pink.....	.10
			7730	Masterpiece. Rich lavender.....	.10
			7738	Miss California. Cream-pink, shaded orange.....	.15
			7740	Mrs. C. W. Breadmore (Evelyn Hemus). Primrose, with rose edge.....	.10

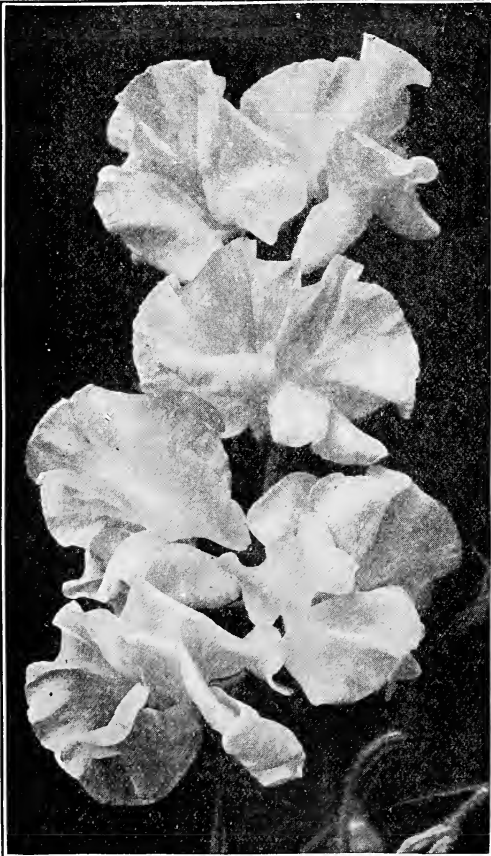

Sweet Peas, R. F. Felton. (See page 59)

No.	SWEET PEAS—Continued	Pkt.
7745	Mrs. Cuthbertson. Very large; clear rose-pink, white wings.	\$0.10
7755	Mrs. Hugh Dickson. Rich, pinkish apricot on cream ground.	.10
7760	Mrs. Routzahn. Apricot, suffused with pink.	.10
7768	Mrs. Tom Jones. Bright delphinium blue.	.10
7777	New Miriam Beaver. Soft shell salmon-pink on cream ground.	.10
7780	Nora Unwin. Large and charming, pure white.	.10
7785	Nubian. Deep chocolate colored self.	.10
7786	Orchid Lavender. Lavender suffused with pink.	.10
7787	Old Rose. Color as named.	.10
7801	Peace. Soft, pale pink.	.10
7802	Picture. Rich pink with a rosy flush shaded with creamy apricot.	.15
7805	Primrose Spencer. Beautiful cream yellow.	.10
7810	Queen Alexandra Spencer. Large, rich scarlet self.	.10
7812	Raven's Wing. Black maroon, the darkest Sweet Pea grown.	.15
7818	R. F. Felton. Pinkish lavender.	.10
7828	Robert Sydenham. Beautiful orange scarlet self.	.10
7830	Rosabelle. Giant deep rose self.	.10
7835	Royal Purple. Rich royal purple.	.10
7838	Royal Scott. Orange scarlet.	.10
7855	Stirling Stent. Rich salmon, suffused with orange.	.10
7865	Tangerine Improved. Glowing orange.	.10
7869	The President. Rich dazzling orange scarlet.	.10
7870	Thomas Stevenson. Rich bright orange scarlet.	.10
7875	Vermilion Brilliant. Large, brilliant scarlet.	.10
7877	Warrior. Giant maroon.	.10
7880	Wedgwood. Bright blue self.	.10

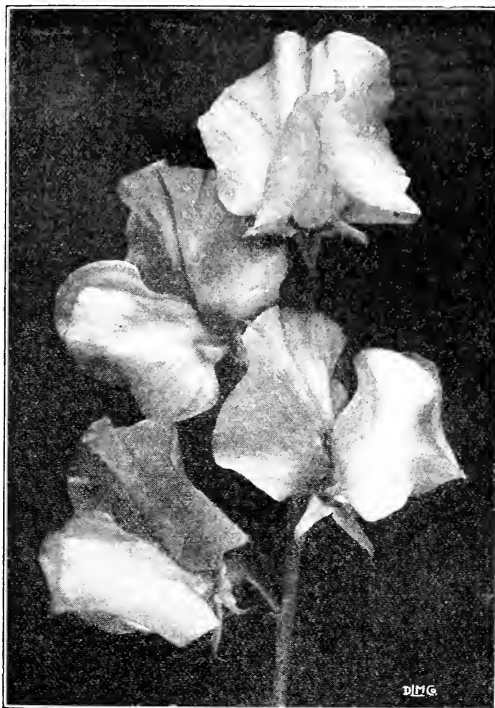

Sweet Peas, White Spencer

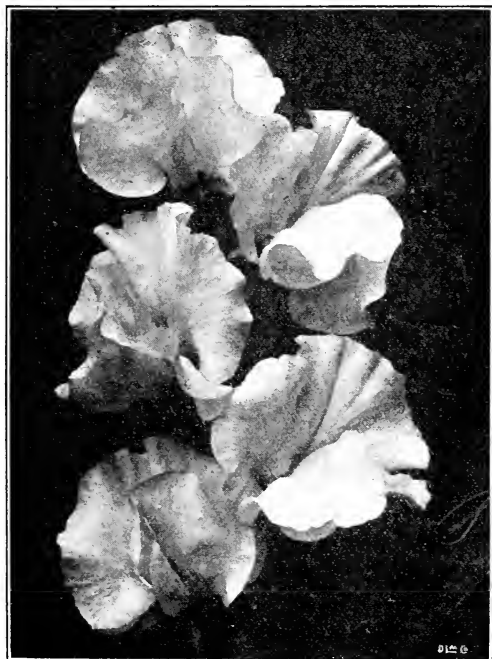

Columbia, Winter-flowering Spencer Sweet Pea

No.	SWEET PEAS—Continued	Pkt.
7885	White Spencer. Pure white.	\$0.10

SPENCER VARIETIES FOR GREENHOUSE.

All white seeded varieties will germinate better if sown in small pots of sand, being less liable to decay and can readily be transplanted to permanent place.

¼ oz. 35c., oz. \$1.00, each, unless priced.

C7493	All White. Large waved, pure white.	.15
C7507	Burpee's Orange. Oz. \$1.50	.15
C7508	Columbia. Salmon-rose and white.	.15
C7608	Edward Zvolanek. Giant lavender.	.15
C7654	Glitters. Cerise.	.15
C7663	Jeanne Mamitsch. Giant rose. Oz. \$2.00	.20
C7693	Lavender King. Very early lavender.	.15
C7742	Mrs. Charles Zvolanek. Lavender.	.15
C7763	New Blue. Deep blue. Oz. \$2.00	.20
C7786	Pink Profusion. Rich pink.	.15
C7847	Snowstorm Improved. Pure white.	.15
C7849	Superior Pink. Rose pink. Oz. \$1.50	.15
C7863	White Harmony. Black seeded. Oz. \$2.50	.25
C7887	Zvolanek's Blue. Bright blue.	.15
C7889	Zvolanek's Rose. Giant rose-pink.	.15

SWEET ROCKET. See *Hesperis*.
SWEET SULTAN. See *Centaurea*.

SWEET WILLIAM. Popular and showy hardy biennial of easiest culture, producing their brilliant colored flowers in great profusion; very desirable for borders and old-fashioned gardens. 1½ ft.

8055	Boston Giant. An extraordinary strain with flowers as large as a half dollar and contains colors not in other strains.	.25
8060	Double Mixed. Very large flowers in choice colors. ¼ oz. 75c.	.15
8065	Holborn Glory. Extra large flowers, finest colors, with clearly defined eyes. ¼ oz. 50c.	.10

SWEET WILLIAM—Continued

No.		Pkt.
8070	Single Finest Mixed. Choice. $\frac{1}{4}$ oz.	50c. \$0.10
8075	Dark Crimson. $\frac{1}{4}$ oz.	50c. .10
8080	Deep Velvety Maroon. $\frac{1}{4}$ oz.	75c. .10
8085	Pure White. $\frac{1}{4}$ oz.	75c. .10
8090	Pink Beauty. Soft pink. $\frac{1}{8}$ oz.	75c. .15
8095	Sutton's Scarlet. Vivid. $\frac{1}{8}$ oz.	75c. .25
8100	Annual Mixed. Flowers of good size and well marked; seed sown in March will bloom the same year. 9 in. $\frac{1}{4}$ oz.	75c. .15

TAGETES. See Marigold.

THUNBERGIA (Black-eyed-susan). Beautiful flowering annual twiners of rapid growth; used extensively in window boxes, vases, etc. 4 ft.

8105	alata. Yellow, with dark eye. $\frac{1}{4}$ oz.	65c. .10
8110	alba. White, with dark eye. $\frac{1}{4}$ lb.	65c. .10
8115	aurantica. Orange, with dark eye. $\frac{1}{4}$ oz.	65c. .10
8120	Mixed. All colors. $\frac{1}{4}$ oz.	50c. .10

TORENIA. Beautiful free flowering, tender annuals, suitable for pot culture in house or conservatory, also excellent for the border during the Summer, and for baskets and vases are unsurpassed. June to October. 1 ft.

8125	baillonii. Golden yellow, purple throat. . .	.25
8130	fournieri grandiflora. Bright blue, with dark blue spots and bright yellow throat. . .	.25
8135	White Wings. Blush-white, yellow throat. . .	.25
8140	TRITOMA semperflorens (Flame Flower). Perpetual flowering, showy perennial, with numerous spikes of orange red flowers from July until frost; excellent for beds or borders. 3 to 4 ft.15
8145	hybrida mirabilis. New dwarf annual strain ranging in color from lemon yellow to deep orange. Sown early and planted out in May they bloom freely from July until frost. 2 ft.15

TROLLIUS (Globeflower). Charming Spring flowering, hardy perennials, with large globular Buttercup-like flowers varying in color from creamy white to orange. 2 ft.

8150	Orange Globe. Large, deep orange.25
8155	Mixed Hybrids. Newest large flowered varieties.25



Sweet William

No.		Pkt.
8160	TROPAEOLUM canariense (Canary-creeper). Well-known climbing annual with elegantly fringed, bright yellow flowers. 10 ft. Oz.	50c. \$0.10
8165	VALERIAN, Mixed. Showy, hardy perennial, with long spikes of heliotrope-scented flowers. Fine old-fashioned border plant and useful for cutting. 2 ft. $\frac{1}{4}$ oz.	35c. .10
8170	officinalis (Garden Heliotrope). Large trusses of fragrant pink flowers. 3 ft.15

VERBENA. These are invaluable for Summer bedding purposes, flowering freely the first season from seed; seedlings are better than cuttings, with less liability to disease and mildew. Seed sown in March will commence to bloom in June and continue until frost. $1\frac{1}{2}$ ft.

8175	Grey's Mammoth, Mixed. A grand strain of giant Verbenas, with flowers and trusses of exceptional size, in the richest and most brilliant colors. $\frac{1}{4}$ oz.	60c., oz. \$2.00 .10
8180	grandiflora Helen Willmott. Large, bright salmon-pink, with white eye.25
8185	Mammoth Auricula-flowered, Mixed. Large flowers, with white eye. $\frac{1}{4}$ oz.	60c. .10
8190	Blue. $\frac{1}{4}$ oz. 75c., oz. \$2.50	.10
8195	Pink. $\frac{1}{4}$ oz. 75c., oz. \$2.50	.10
8200	Scarlet. $\frac{1}{4}$ oz. 75c., oz. \$2.50	.10
8205	Striped. $\frac{1}{4}$ oz. 75c., oz. \$2.50	.10
8210	White. $\frac{1}{4}$ oz. 75c., oz. \$2.50	.10
8215	Lemon Verbena (Aloysia citriodora). Fragrant foliage for cutting.15
8222	venosa. Half hardy perennial. Purple flowers. $\frac{1}{4}$ oz.	50c. .15

VERONICA. Splendid hardy perennials, with showy spikes of bright colored flowers; fine border plant. $1\frac{1}{2}$ to 2 ft.

8225	spicata Blue. Bright blue. $\frac{1}{4}$ oz.	50c. .20
8227	spicata, Mixed. $\frac{1}{4}$ oz.	50c. .20

No.		Pkt.
	VINCA. Handsome, profuse blooming half-hardy perennials, flowering the first season from seed. They have dark green foliage and pretty pink and white flowers; excellent for borders and bedding out. 1 ft.	
8235	Bright Rose. $\frac{1}{4}$ oz. 75c., oz. \$2.50	\$0.10
8240	Pure White. $\frac{1}{4}$ oz. 75c., oz. \$2.50	.10
8245	White, with Rose Eye. $\frac{1}{4}$ oz. 75c., oz. \$2.50	.10
8250	Mixed. All colors. $\frac{1}{4}$ oz. 75c., oz. \$2.50	.10

VIOLA cornuta (Tufted Pansies). Fine flowering plants, excellent for partially shaded beds or borders, blooming throughout the season; more hardy than other Pansies, but with smaller flowers.

8255	Admiration. Rich, dark blue. $\frac{1}{4}$ oz.	\$1.75 .15
8260	Blue Perfection. Light blue. $\frac{1}{4}$ oz.	\$1.75 .15
8265	lutea. Old yellow sort. $\frac{1}{4}$ oz.	\$1.50 .15
8270	rosea. Delicate rose. $\frac{1}{4}$ oz.	\$1.75 .15
8275	White Perfection. Large white. $\frac{1}{4}$ oz.	\$1.50 .15
8280	Mixed. Finest varieties. $\frac{1}{4}$ oz.	\$1.25 .25
8285	Scotch Strains. Choicest and newest bedding hybrids in finest colors.25
8287	Sutton's Bedding Apricot. Rich apricot tinged orange center.50



Verbena



Zinnia

No.		Pkt.
8288	VIOLA Jersey Gem. A large, compact growing variety, continuous bloomer, deep violet-blue; a fine rockery and border plant....	\$0.30
	VIOLA odorata (Sweet-scented Violet). A favorite hardy perennial much in demand on account of its abundant and fragrant blossoms. Easily grown from seed, doing best in a cool, moist situation.	
8295	The Czar. Very large dark blue.	1/8 oz. 75c. .15
8300	White Czar. Very large white.	1/8 oz. 75c. .15
8305	Mixed. Blue and white shades.	1/8 oz. 50c. .10
8310	VIRGINIAN STOCK, Mixed. Early free flowering hardy annual, with bright colored flowers; doing well in any soil.	1/4 oz. 20c. .10
8315	VISCARIA, Finest Mixed. Remarkably showy, free flowering hardy annual, for border or masses. The bright flowers are continued through the season. 1 ft.....	1/4 oz. 15c. .10
	WALLFLOWER. Deliciously fragrant half-hardy perennials, with beautiful velvety flowers, mostly in the rich dark colors. 2 ft.	
8320	Double Branching, Mixed.	1/2 oz. \$1.50 .25
8325	Kewensis. Very fragrant flowers varying from sulphur-yellow to orange and purple-violet. Sown in July it blooms constantly from November until Spring.	1/4 oz. \$1.50 .25
8330	Vulcan. Extra large, velvety crimson-brown flowers.	1/4 oz. 60c. .15
	WALLFLOWER, Annual. A new strain of early flowering single varieties which bloom throughout the Summer from Spring-sown seed, and are excellent for bedding purposes. 2 ft.	
8335	Blood Red	1/4 oz. 50c. .15
8340	Earliest Paris. Fine brown.	1/4 oz. 50c. .15
8345	Golden Yellow	1/4 oz. 50c. .15
8350	Mixed. All colors.	1/4 oz. 50c. .15

No.		Pkt.
8355	WHITLAVIA grandiflora. Blue flowered, pretty hardy annual, producing throughout the season its bright bell-shaped flowers; adapted to poor soils. 1 ft.....	1/4 oz. 35c. \$0.10
8360	grandiflora alba. White.....	1/4 oz. 35c. .10
	WILD CUCUMBER. See <i>Echinocystis</i> .	
8365	XERANTHEMUM, Double, Mixed. Showy hardy annual of easy culture, giving a profusion of flowers; well suited to drying as everlasting. 1 1/2 to 2 ft.....	1/4 oz. 50c. .15
8370	YUCCA filamentosa (Adam's Needle). Fine hardy perennials. The flower spikes are many branched, and the large white, waxy flowers of drooping habit are borne in huge panicles above the sword-shaped foliage, during July and August. 4 ft.	1/4 oz. 75c. .15
8374	ZEA japonica Rainbow. Green, white, rose and yellow striped foliage. 5 ft....	Oz. 25c. .10
8375	japonica variegata. Beautifully striped green and white foliage. 6 ft.....	Oz. 25c. .10
8380	gracillima variegata (Miniature Maize). Slender, striped foliage. 3 ft.....	Oz. 25c. .10
	ZINNIA. These attractive and decorative hardy annuals are most desirable for borders or bedding purposes, and are remarkable for the profusion and duration of their flowers, which are notable for their large size, fine form, brilliancy and diversity of color; in bloom from June to frost. 1 to 2 ft.	
	Double Giant Flowering Columbia Strain. Saved from selected prize flowers. 2 ft.	
8389	Bright Rose	1/4 oz. 50c. .10
8390	Carminé	1/4 oz. 50c. .10
8395	Dark Scarlet	1/4 oz. 50c. .10
8400	Deep Maroon	1/4 oz. 50c. .10
8405	Flesh Pink	1/4 oz. 50c. .10
8410	Golden Yellow	1/4 oz. 50c. .10
8415	Lemon Yellow	1/4 oz. 50c. .10
8420	Lilac	1/4 oz. 50c. .10
8425	Scarlet	1/4 oz. 50c. .10
8430	Striped	1/4 oz. 50c. .10
8435	White	1/4 oz. 50c. .10
8440	Columbia Prize Mixture	1/4 oz. 50c. .10
8445	Collection of 6 colors. Our selection....	.50
8450	Dwarf Crimson. 1 ft.....	1/4 oz. 50c. .10
8455	Bright Rose	1/4 oz. 50c. .10
8460	Carminé	1/4 oz. 50c. .10
8465	Dazzling Scarlet	1/4 oz. 50c. .10
8470	Flesh Pink	1/4 oz. 50c. .10
8475	Golden Yellow	1/4 oz. 50c. .10
8480	White	1/4 oz. 50c. .10
8485	Mixed. All colors.....	1/4 oz. 50c. .10
8490	Collection of 6 colors. Our selection....	.50
8495	Curled and Crested, Mixed. Select strain of double flowers, with curled and twisted petals. 2 ft.....	1/4 oz. 60c. .15
8500	Giant, Mixed. Enormous double flowers in choice colors. 2 ft.....	1/4 oz. 75c. .25
8501	Giant Achievement. Very large, semi-cactus like form. Mixed.....	1/4 oz. 50c. .15
8505	Lilliput, Mixed. Very small double, fine for borders. 9 in.....	1/4 oz. 50c. .15
8510	Crimson Gem. Deep crimson...	1/4 oz. 50c. .15
8515	Golden Gem. Golden yellow...	1/4 oz. 50c. .15
8520	Scarlet Gem. Dazzling scarlet...	1/4 oz. 50c. .15
8525	White Gem. Pure white.....	1/4 oz. 50c. .15

MIXED FLOWER SEEDS FOR WILD GARDENS

"Wild Gardens" have proved a marked success; and we are in receipt of the most satisfactory evidence of the estimation in which they are held. Anyone who has cultivated flowers knows the constant attention necessary in the care of well laid out beds and borders. To those who cannot give this care, the "Wild Garden" presents a substitute which, for its unusual and varied effects, cheapness, and the small amount of labor necessary for its construction, has no rival. "Wild Garden" seeds are a mixture of over one hundred varieties of flower seeds, and, being mixed together, can be offered at a much less price than when sold in separate packets. The different seasons of bloom insuring something new almost every day.

8530 **Dwarf Sorts.** ½ oz. pkts., with full directions.....Each 20c., oz. 40c., 4 ozs. \$1.25, lb. \$3.50
 8535 **Tall Sorts.** ½ oz. pkts., with full directions.....Each 20c., oz. 40c., 4 ozs. \$1.25, lb. \$3.50

GREY'S COLLECTION OF FLOWER SEED FOR SUMMER HOMES

In response to the numerous inquiries, "What can I plant at my Summer home that will give me a good display through the season and flowers to cut for the house," we have made up the following collection which has given great satisfaction to our customers. The quantity is sufficient for a large garden and price \$2.25, postpaid.

1 oz. Sweet Peas, Columbia mixture; 1 oz. Tall Nasturtiums, special mixture; ½ oz. wild garden mixture, and a pkt. each of the following: Sweet Alyssum, Asters, Bachelor Buttons, Chrysanthemum, Clarkia, Coreopsis, Chinese Pinks, Eschscholtzia, Gaillardia, Godetia, Miniature Sunflower, Bar Harbor Marshmallows, Lupins, Marigold, Mignonette, Nicotiana, Shirley Poppies, Scabiosa, Zinnia.

ORNAMENTAL GRASSES

For borders and ornamental gardening; also, when dried, for Winter bouquets and decorations, for which purpose they should be gathered before fully matured.

No.		Pkt.	No.		Pkt.
8540	Finest Mixed. In great variety, for bouquets.	\$0.10	8570	Eulalia japonica zebrina. Beautiful variegated leaves with yellow bars running crosswise; half-hardy perennial. 5 ft.	\$0.10
8545	Avena sterilis (Animated Oats). Annual. 1½ ft.	.10	8575	Gynerium argenteum (Pampas Grass). Large, silvery plume; half hardy perennial. 10 ft.	.10
8550	Arundo donax variegata. Variegated foliage; half-hardy perennial. 7 ft.	.10	8580	Hordeum jubatum (Squirrel's Tail). Annual. 2 ft.	.10
8555	Briza maxima (Quaking Grass). Annual. 1 ft.	.10	8585	Lagurus ovatus (Hare's Tail). Annual. 1 ft.	.10
8560	Bromus brizaeformis. Drooping; annual. 1½ ft.	.10	8590	Pennisetum rupellanum. Beautiful crimson-purple plumes, from Spring-sown seed. ¼ oz.	.60c.
8565	Coix lachryma (Job's Tears). Striped leaves; annual. 2 ft.	.10	8595	Stipa elegantissima (Feather Grass). 2 ft. ¼ oz.	\$1.00



PALMS, FERNS AND DECORATIVE PLANTS

Unless otherwise directed we ship all this class of plants by express, as we consider it much more safe, and the principal express companies charge 20 per cent less than their regular merchandise rates on plants packed in covered boxes or crates.

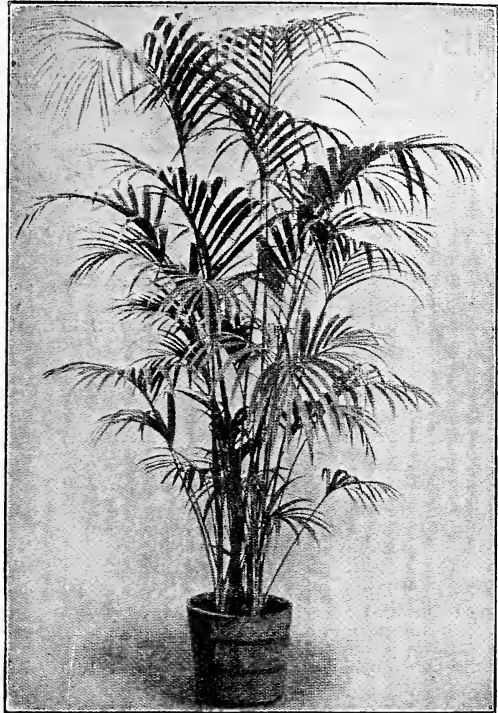

Kentia

- ALLAMANDA Hendersoni.** A strong growing green-house climber producing numerous large golden-yellow flowers; suitable for covering a trellis or the supports of a conservatory. \$1.50 and \$2.50 each.
- ARALIA.** Handsome foliage plants for conservatory decoration.
- elegantissima.** \$2.25 and \$2.75 each.
- Veitchii.** Dark green narrow leaflets, red underneath. \$1.25 and \$2.00 each.
- Veitchii gracillima.** Very graceful foliage. \$2.25 and \$2.75 each.
- ASPARAGUS plumosus nanus** (Asparagus Fern). Bright green, delicate foliage. 25c. and 35c. each; \$2.50 and \$3.50 per doz.
- Sprengeri.** Excellent for the window box, hanging baskets and for cutting. 20c. and 30c. each; \$2.00 and \$3.00 per doz.
- ASPIDISTRA.** A decorative plant well suited for shady nooks and places away from the light; will succeed where other plants fail.
- lurida.** Long green leaves. \$2.25 to \$5.00 each.
- lurida variegata.** Green and white striped foliage. \$2.25 to \$5.00 each.
- BEGONIA. Gloire de Melior and Gloire de Cincinnati.** Two varieties of Winter blooming Begonias of same habit as the old Gloire de Lorraine but larger leaved and more brilliant color. 2¼-in. pots \$6.00 per doz., 3½-in. pots \$9.00 per doz.
- Rex.** Beautiful ornamental foliage. 50c. to \$2.50 each.

CROTONS. Beautiful and rich colored foliage, for conservatory decoration, exhibition and bedding. Leading varieties. \$1.50 to \$5.00 each.

CYPERUS alternifolius (Umbrella Plant). Fine for house culture when liberally supplied with water. 25c. and \$1.00 each.

DRACENAS. Excellent decorative plants for house and conservatory.

fragrans. Broad, dark green foliage. \$2.50 to \$6.00 each.

Godseffiana. Rich, dark green, with creamy white spots. \$1.00 to \$4.00 each.

indivisa. Long, narrow foliage used in vases, etc. 50c. to \$2.00 each.

Lindeni. Broad, green foliage, with golden yellow stripes on the edges. \$2.00 to \$4.00 each.

Massangena. Like preceding, with stripe through the center of leaf. \$3.00 to \$7.50 each.

terminalis. Rich red foliage, marked with pink and white. \$1.00 and \$3.00 each.

FERNS. We have an immense quantity of nice, bushy plants in fine varieties for filling dishes. \$2.00 per doz., \$10.00 per 100.

Adiantum. In leading sorts. 2¼-in. pots, \$2.00 per doz., 3-in. pots \$3.00 per doz., 4-in. pots 75c. each.

Pteris. In best varieties. 2¼-in. pots \$2.00 per doz., \$10.00 per 100; 3-in. pots \$3.00 per doz., \$13.00 per 100; 4-in. pots 50c. each.

Nephrolepis (Sword Fern). In following varieties: **Bostoniensis, Piersoni, Scotti, Whitmani.** 50c. to \$5.00 each.

FICUS (Rubber Plant). Extensively used in house decoration.

elastica. The common Rubber Plant. \$1.50 to \$3.50 each.

pandurata. New, with beautiful foliage. \$1.50 to \$3.00 each.

MARANTA. Fine decorative plants, with beautiful variegated foliage.

Various Sorts. 25c. and 50c. each.

We can supply many other varieties of greenhouse plants not listed in this catalogue. Prices on request.

PALMS

KENTIAS, Belmoreana and Fosteriana. These are considered the hardiest palms and best adapted to house culture. The foliage is rich dark green and of spreading habit. 4-in. pots \$1.00 each, 5-in. pots \$2.00 each, 6-in. pots \$5.00 each, 7-in. pots \$7.50 each, 8-in. pots \$15.00 to \$20.00 each.

COCOS Weddelliana. The most elegant and graceful of all the palms, the smaller sizes being excellent for fern dishes. 2¼-in. pots 50c. each, 3-in. pots 75c. each, 6-in. pots \$2.25 and \$2.75 each.

LATANIA Borbonica. Popular fan-leaved variety. 4-in. pots \$2.00 each, 6-in. pots \$5.00 each, 7-in. pots \$7.50 each, 8-in. pots \$10.00 each.

PHENIX Canariensis (Date Palm). Dark green feathery foliage. \$5.00 each.

Roebelenii. Most graceful variety. 8 and 10-in. pots \$15.00 to \$20.00 each.

SUMMER-FLOWERING BULBS AND TUBEROUS ROOTS

Gladiolus

For general garden decoration and for cut flowers the Gladiolus is deserving of special attention. Very effective for massing in large beds where a brilliant effect is desired. Of easiest culture, seldom disappointing and immune from insect pests. They thrive in well prepared enriched loam planted 3 inches deep and 6 inches apart. Frequent watering very beneficial.

We respectfully call your attention to the several new varieties listed for the first time this year, many of them Kunderd's and Diener's finest originations. Six bulbs offered at the dozen rate.

	Doz.	100																																																									
Columbia Prize Mixture. The most satisfactory mixture to grow, being selected from collections of the best hybridizers and growers of both continents with a view of eliminating all colors which do not harmonize either in cut flower or garden planting....																																																											
1000, \$57.00	\$0.85	\$6.50																																																									
Home Garden Mixture. A superior strain unlimited as to size, color and markings.																																																											
1000, \$30.00	.50	3.50																																																									
American Beauty (New). A variety well-named, being American Beauty Rose color, yellow throat. Diener's famous variety....	2.00																																																									
Anthony B. Kunderd. A beautiful deep cream variety with overspread of blush pink. Intensely ruffled.....	2.00																																																									
Anna Eberius. Reddish purple with cardinal shade on lower lips. Tall straight spikes; in a color by itself.....	1.25	9.00																																																									
America. Soft lavender pink; one of the finest ever sent out.....	1000, \$32.00	.50 3.50																																																									
<div style="display: flex; justify-content: space-between;"> <div style="width: 48%;">  </div> <div style="width: 48%;"> <table border="0" style="width: 100%; border-collapse: collapse;"> <thead> <tr> <th style="width: 80%;"></th> <th style="width: 10%; text-align: right;">Doz.</th> <th style="width: 10%; text-align: right;">100</th> </tr> </thead> <tbody> <tr> <td>Baron Hulot. Deep violet-blue, one of the finest.....</td> <td style="text-align: right;">\$1.50</td> <td style="text-align: right;">\$10.00</td> </tr> <tr> <td>Break o'Day. A clear light pink. In habit and growth very similar to Halley.....</td> <td style="text-align: right;">2.50</td> <td style="text-align: right;">....</td> </tr> <tr> <td>Byron L. Smith. A beautiful, delicate lavender-pink on white ground, yellow throat.</td> <td style="text-align: right;">1.50</td> <td style="text-align: right;">10.00</td> </tr> <tr> <td>Carmen Sylva. A pure white except for slight violet markings in throat. One of the best whites.....</td> <td style="text-align: right;">2.00</td> <td style="text-align: right;">15.00</td> </tr> <tr> <td>Crimson Glow. Deep crimson, lighter in throat. Exhibition variety.....</td> <td style="text-align: right;">1.25</td> <td style="text-align: right;">9.00</td> </tr> <tr> <td>Dr. F. E. Bennett (New). A very large fiery red. Considered Diener's best red.....</td> <td style="text-align: right;">3.00</td> <td style="text-align: right;">....</td> </tr> <tr> <td>Elizabeth Tabor. (New). This variety known as the earliest to bloom is a very high-class introduction. Delicate rosy-pink on white ground, rich dark crimson spot on lower petals.....</td> <td style="text-align: right;">2.50</td> <td style="text-align: right;">....</td> </tr> <tr> <td>Evelyn Kirtland. A very strong, tall variety, a beautiful shade of rosy pink, shading from shell pink at center to dark rose at edge; lower petals blotched with scarlet.....</td> <td style="text-align: right;">1.00</td> <td style="text-align: right;">7.00</td> </tr> <tr> <td>Fern Kyle. Kunderd's massive creamy white exhibition variety.....</td> <td style="text-align: right;">3.00</td> <td style="text-align: right;">....</td> </tr> <tr> <td>Golden Glory. Very choice, ruffled variety. Richly colored yellow with beautiful throat, blotched red.....</td> <td style="text-align: right;">2.50</td> <td style="text-align: right;">....</td> </tr> <tr> <td>Gold. Fine golden yellow, darker lip; considered the best in yellow.....</td> <td style="text-align: right;">2.00</td> <td style="text-align: right;">....</td> </tr> <tr> <td>Golden Measure. Fine deep yellow. Large open flowers; vigorous grower.....</td> <td style="text-align: right;">2.00</td> <td style="text-align: right;">....</td> </tr> <tr> <td>Halley. Very large, lovely salmon-pink; the lower petals have yellow blotch with carmine markings.....</td> <td style="text-align: right;">.60</td> <td style="text-align: right;">4.00</td> </tr> <tr> <td>Henry Ford. Very dark rhodamine purple, shading to a deeper color near the centre. A wonderful color and a very showy variety.....</td> <td style="text-align: right;">2.00</td> <td style="text-align: right;">....</td> </tr> <tr> <td>Herada. A large, tall variety of a pure glistening mauve.....</td> <td style="text-align: right;">1.25</td> <td style="text-align: right;">9.00</td> </tr> <tr> <td>Jenny Lind. A more refined or beautiful variety could not be desired. Its soft apricot-pink, pale yellow throat are colors which blend well together.....</td> <td style="text-align: right;">2.50</td> <td style="text-align: right;">....</td> </tr> <tr> <td>John T. Pirie (New). A color most unusual, being mahogany brown with yellow bordered brown throat.....</td> <td style="text-align: right;">3.50</td> <td style="text-align: right;">....</td> </tr> <tr> <td>Longfellow (New). Considered the best pink. A tall grower with large open flowers, perfectly placed.....</td> <td style="text-align: right;">3.50</td> <td style="text-align: right;">....</td> </tr> </tbody> </table> </div> </div> <div data-bbox="326 1507 409 1529" data-label="Caption"> <p style="text-align: center;">America</p> </div>				Doz.	100	Baron Hulot. Deep violet-blue, one of the finest.....	\$1.50	\$10.00	Break o'Day. A clear light pink. In habit and growth very similar to Halley.....	2.50	Byron L. Smith. A beautiful, delicate lavender-pink on white ground, yellow throat.	1.50	10.00	Carmen Sylva. A pure white except for slight violet markings in throat. One of the best whites.....	2.00	15.00	Crimson Glow. Deep crimson, lighter in throat. Exhibition variety.....	1.25	9.00	Dr. F. E. Bennett (New). A very large fiery red. Considered Diener's best red.....	3.00	Elizabeth Tabor. (New). This variety known as the earliest to bloom is a very high-class introduction. Delicate rosy-pink on white ground, rich dark crimson spot on lower petals.....	2.50	Evelyn Kirtland. A very strong, tall variety, a beautiful shade of rosy pink, shading from shell pink at center to dark rose at edge; lower petals blotched with scarlet.....	1.00	7.00	Fern Kyle. Kunderd's massive creamy white exhibition variety.....	3.00	Golden Glory. Very choice, ruffled variety. Richly colored yellow with beautiful throat, blotched red.....	2.50	Gold. Fine golden yellow, darker lip; considered the best in yellow.....	2.00	Golden Measure. Fine deep yellow. Large open flowers; vigorous grower.....	2.00	Halley. Very large, lovely salmon-pink; the lower petals have yellow blotch with carmine markings.....	.60	4.00	Henry Ford. Very dark rhodamine purple, shading to a deeper color near the centre. A wonderful color and a very showy variety.....	2.00	Herada. A large, tall variety of a pure glistening mauve.....	1.25	9.00	Jenny Lind. A more refined or beautiful variety could not be desired. Its soft apricot-pink, pale yellow throat are colors which blend well together.....	2.50	John T. Pirie (New). A color most unusual, being mahogany brown with yellow bordered brown throat.....	3.50	Longfellow (New). Considered the best pink. A tall grower with large open flowers, perfectly placed.....	3.50
	Doz.	100																																																									
Baron Hulot. Deep violet-blue, one of the finest.....	\$1.50	\$10.00																																																									
Break o'Day. A clear light pink. In habit and growth very similar to Halley.....	2.50																																																									
Byron L. Smith. A beautiful, delicate lavender-pink on white ground, yellow throat.	1.50	10.00																																																									
Carmen Sylva. A pure white except for slight violet markings in throat. One of the best whites.....	2.00	15.00																																																									
Crimson Glow. Deep crimson, lighter in throat. Exhibition variety.....	1.25	9.00																																																									
Dr. F. E. Bennett (New). A very large fiery red. Considered Diener's best red.....	3.00																																																									
Elizabeth Tabor. (New). This variety known as the earliest to bloom is a very high-class introduction. Delicate rosy-pink on white ground, rich dark crimson spot on lower petals.....	2.50																																																									
Evelyn Kirtland. A very strong, tall variety, a beautiful shade of rosy pink, shading from shell pink at center to dark rose at edge; lower petals blotched with scarlet.....	1.00	7.00																																																									
Fern Kyle. Kunderd's massive creamy white exhibition variety.....	3.00																																																									
Golden Glory. Very choice, ruffled variety. Richly colored yellow with beautiful throat, blotched red.....	2.50																																																									
Gold. Fine golden yellow, darker lip; considered the best in yellow.....	2.00																																																									
Golden Measure. Fine deep yellow. Large open flowers; vigorous grower.....	2.00																																																									
Halley. Very large, lovely salmon-pink; the lower petals have yellow blotch with carmine markings.....	.60	4.00																																																									
Henry Ford. Very dark rhodamine purple, shading to a deeper color near the centre. A wonderful color and a very showy variety.....	2.00																																																									
Herada. A large, tall variety of a pure glistening mauve.....	1.25	9.00																																																									
Jenny Lind. A more refined or beautiful variety could not be desired. Its soft apricot-pink, pale yellow throat are colors which blend well together.....	2.50																																																									
John T. Pirie (New). A color most unusual, being mahogany brown with yellow bordered brown throat.....	3.50																																																									
Longfellow (New). Considered the best pink. A tall grower with large open flowers, perfectly placed.....	3.50																																																									

GLADIOLUS—Continued Doz. 100

- Los Angeles.** Delicate pink with corise feather in throat. Very often called the "cut-and-come-again variety".....\$2.50
- Louise.** A very popular lavender and not high in price. The blooms are bright lavender with wine-colored blotch in throat. A variety which should be in everybody's garden..... 1.50
- Le Marechal Foch.** Apple blossom pink with rosy carmine center. Large flowers and a very early variety..... .60 \$4.00
- Marietta.** A delicate shade of light salmon, blended with light orange. Lower petals shading to a bright burnt orange. A marvelous gladiolus..... 3.50
- Mary Pickford.** Delicate creamy white, throat sulphur-yellow. One of the best.... 1.50 10.00
- Mrs. H. E. Bothin.** Light pink, heavily ruffled, scarlet center..... 2.00
- Mrs. Dr. Norton.** A pure white, with tips of petals La France pink. Finest variety of this type..... 1.25 9.00
- Mrs. F. C. Peters.** Beautiful shade of rosy-lilac, crimson blotched, bordered white on lower segment..... 2.50
- Mrs. Frank Pendleton.** Fine large salmon-pink, with blood-red blotch at throat.... .80 6.00
- Mrs. Francis King.** Immense flowers of a flame-pink or light scarlet..... .60 4.00
- Mrs. Leon Douglass.** One of the largest, showiest and most vigorous in existence. Color is rose, striped with brilliant scarlet, pale lemon lip..... 3.00
- Peace.** Pure white with delicate lilac feathering, strong grower..... .75 5.00
- Persia.** Darkest variety known. The color is deep red of the mahogany tone, so dark as to appear almost black. Always creates interest wherever shown..... 3.50
- Purple Glory.** Deep velvety maroon with darker blotch. Elegantly ruffled..... 2.00
- Pink Lily (New).** Very popular variety. A beautifully ruffled, deep rose pink..... 2.50



Gladiolus, Columbia Prize Mixture

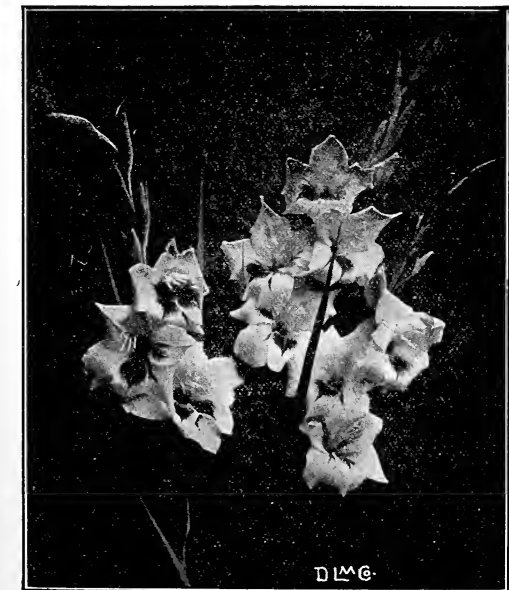

Elizabeth Tabor

- Doz. 100
- Richard Diener (New).** This variety has 10 to 12 blooms well placed, open at one time. Very live rose-salmon, with creamy yellow center. Considered the finest variety of its color.....\$3.50
- Rose Glory.** One of the most popular rose-pink varieties. Heavily ruffled..... 1.50 \$10.00
- Rev. Ewbank.** Light porcelain blue, very much admired..... 2.00
- Rose Ash.** A very popular variety and a rare color. Corinthian red, fading to ashes of Roses..... 1.75 12.00
- Schwaben.** Soft pure yellow with small dark spot in throat. Extra..... .75 5.00
- W. H. Phipps.** Beautiful flesh-pink with about twenty-two blooms to a spike and nearly all opening at a time..... 3.50

PRIMULINUS VARIETIES

- Alice Tiplady.** A soft burnt orange. The queen of the Primulinus type..... 1.00 7.00
- Ethelyn.** One of the best primulinus varieties. A beautiful shade of orange yellow, petals tipped with bronze..... 3.50
- Jewel.** One of the best in Primulinus type. Salmon-pink with beautiful yellow throat.. 1.50 10.00
- Maiden's Blush.** Blush pink with finely formed flowers. Free flowering and very early..... .80 6.00
- Souvenir.** Tall stemmed, deep yellow variety four to six open at same time. Good keeper and early..... 1.75 12.00
- Salmon Beauty.** Deep salmon, rich yellow throat. A very striking primulinus..... 1.50 9.00
- White Butterfly (New).** Beautiful Kunder variety. Pure white, Butterfly form..... 2.50
- Mixture.** Containing a fine collection of popular named varieties..... .75 5.00

LILIES

In the flower garden Lilies rank first in importance. They are stately and beautiful, matchless in form and variety of color, while possessing the most agreeable perfume, and for general effect they have no rivals. Bulbs should be planted 6 inches deep in a well-drained, deep, loamy soil made rich with thoroughly rotted manure, and an inch of clean sand placed under and over the bulbs when setting.

Each Doz. 100

Auratum (Golden-rayed Lily of Japan). Large, pure white flowers, with crimson spots and a golden band through the center of each petal. 2 to 4 ft. high, blooming from July to October. Large bulbs.....\$0.40 \$4.00 \$30.00
Mammoth bulbs..... .50 5.00 40.00

Canadense flavum. Bright yellow spotted with black. 2 to 3 ft. June and July..... .25 2.50 20.00

Henryi (Yellow Speciosum). Beautiful Lily from China. Rich apricot yellow, reddish-brown spots. 5 ft. July and Aug..... .75 7.50 60.00



Lilium speciosum

Longiflorum (Japan-grown). Pure white; trumpet-shaped. 2 ft. June.. .40 3.75 30.00

Speciosum album. Large, fragrant, pure white. Large bulbs..... .60 5.00 40.00

Speciosum magnificum. Rich red, heavily spotted; much larger and richer colored than the other varieties. Large bulbs..... .40 3.75 30.00
Mammoth bulbs..... .60 6.00 45.00

Speciosum melpomene. White, shaded with rich blood crimson; heavily spotted. Large bulbs..... .40 3.75 30.00
Mammoth bulbs..... .60 6.00 45.00

Speciosum rubrum, or roseum. White, shaded and spotted rosy crimson; fragrant. Large bulbs..... .40 3.75 30.00
Mammoth bulbs..... .60 6.00 45.00

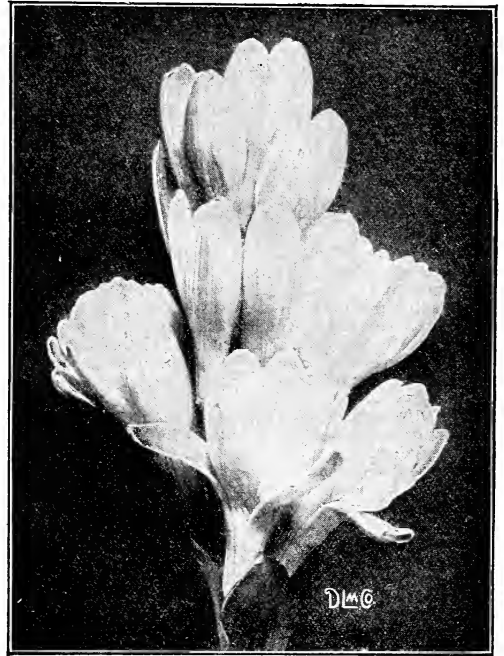

Tuberosa

Each Doz. 100

Superbum (Native Turks-cap). Rich orange, petals tipped with red, and spotted. 4 to 6 ft. July.....\$0.25 \$2.50 \$20.00
Tigrinum splendens (Tiger Lily). Orange salmon, spotted; the finest form. Mammoth bulbs..... .35 3.00 22.00

LILY-OF-THE-VALLEY

(*Convallaria*)

Grey's Perfect Forcing Pips. The finest grade of pips that come to this country and especially selected for our large, private trade, which demands only the best for forcing throughout the year. *We carry these in cold storage and can furnish them at any time.* Three to four weeks are usually allowed for forcing cold storage pips into flower. Per case of 250, \$16.00.

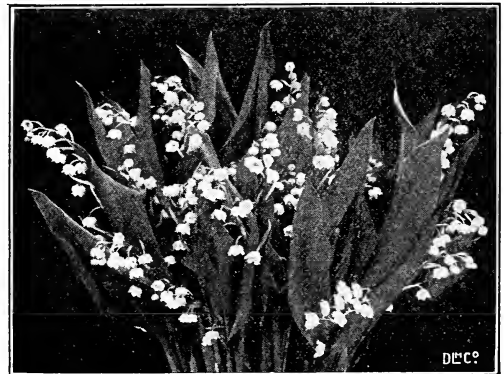

Lily-of-the-valley

ACHIMENES

One of the finest Summer blooming plants for house or conservatory, giving handsome flowers of many shades and colors.

Finest Mixed Varieties. Doz. \$3.00, 100 \$20.00.

BEGONIAS

Splendid pot plants for the house or greenhouse, and especially valuable for bedding, flowering in the greatest profusion throughout the Summer. For bedding they should be started in hotbed in March and April.

SINGLE TUBEROUS ROOTED

Separate Colors. Crimson, pink, white, yellow, salmon, scarlet. Each 35c., doz. \$3.00, 100 \$22.00.

DOUBLE TUBEROUS ROOTED

Separate Colors. Crimson, pink, white, yellow, salmon, scarlet. Each 40c., doz. \$3.50, 100 \$25.00.

CANNAS, Dormant Roots

A class of plants for grand effects. Their rich and varicolored leaves, combined with large and beautiful flowers of brilliant colors, make them very desirable for planting in groups on the lawn, or singly in beds. Keep the roots in a warm, dry place through the Winter.

Robusta. Very dark foliage; robust grower, 6 to 8 ft. Each 15c., doz. \$1.50.

Large Flowering French Mixed. Finest varieties. Each 15c., doz. \$1.50.

DAHLIAS

Special Dahlia Catalog mailed on application

We are agents for one of the largest and best growers of Dahlias in the East. A descriptive catalog with prices of all new and up-to-date sorts, as well as older varieties, with directions for culture and treatment, will be mailed to all our customers who apply.

GLOXINIAS, Large-Flowered

Magnificent for house or conservatory, producing in great profusion flowers of the richest and most beautiful colors. They succeed best in sandy loam and peat, and require a moist heat.

Purple, purple bordered, scarlet, scarlet bordered, mixed. Doz. \$5.00.

HYACINTHUS CANDICANS

A magnificent species, with flower stems 3 feet high, bearing large, pure white flowers in July and August. It is perfectly hardy. Extra large bulbs. Doz. \$1.50, 100 \$10.00.

MADEIRA VINES

A rapid climbing plant, with beautiful, wax-like, light green leaves and feathery white flowers, with a delicious fragrance resembling Mignonette. The culture is simple, the roots need but to be planted and a trellis or strings given the vine to climb on. Selected bulbs. Each 10c., doz. \$1.00.



Montbretias

MONTBRETIAS

One of the best and brightest Summer flowering bulbs sure of becoming firm favorites wherever grown. Planted in clumps from April to June they produce numerous graceful spikes of brilliant star-shaped flowers. Hardy with protection.

Crocsmæflora. Scarlet and yellow. 60c. per doz., \$4.50 per 100.

George Davison. Large orange-yellow. \$1.10 per doz., \$8.00 per 100.

Fire King. Large, glowing scarlet red. One of the best new reds. \$1.75 per doz., \$12.00 per 100.

California. Deep golden yellow. Doz. \$1.00, 100 \$7.50.

Hereward. Late, large flowering, yellow, shaded orange on the outside. Doz. \$1.50, 100 \$10.00.

King Edmund. Tall stemmed, rich golden yellow with brown markings. Doz. \$1.75, 100 \$12.00.

TUBEROSES

A bulbous plant of the easiest culture and most delightful fragrance, suitable for the Summer garden or house culture throughout the year. They should be started early in pots, using good, rich, loamy soil, and when the weather is suitable, transplanted into the garden. The variety offered is the one most extensively grown, being much superior to all other sorts.

Excelsior Pearl. A superior strain, with very large double white flowers, produced in great abundance. Extra large bulbs, \$1.25 per doz., \$9.00 per 100.

Foliage and Flowering Plants

FOR SUMMER BEDDING

	Doz.	100
Abutilon	\$3.00	\$25.00
Alternanthera, Dwarf Scarlet	1.50	10.00
Alternanthera, Dwarf Yellow	1.50	10.00
Achyranthes. Bright crimson	1.75	12.00
Achyranthes. Green and white	1.75	12.00
Ageratum. Blue or white	2.00	15.00
Alyssum, Double White	1.50	10.00
Alyssum, Single White	1.25	9.00
Antirrhinum (Snapdragon), Assorted	2.00	15.00
Asters. Assorted colors. Double60	4.00
Asters, Double White60	4.00
Begonia, Gracilis	2.50	18.00
Begonias. In variety	2.50	18.00
Caladium esculentum	3.50	25.00
Calendula. Orange King	1.75	13.00
Cannas, Dwarf Large-flowering	2.75	22.00
Canna robusta. Tall; dark foliage	2.75	22.00
Carnations for Summer-flowering. Strong plants out of 3-inch pots and the best sorts for this purpose only furnished	3.00	22.00
Centaurea candidissima	1.75	12.00
Centaurea gymnocarpa	1.75	12.00
Chrysanthemums. Our collection of these beautiful Fall-blooming plants embraces the best of the old and newer introductions	2.50	
Cobæa scandens	2.75	22.00
Coleus. Fine varieties	1.50	10.00
Cosmos. Early flowering	1.25	8.00
Daisy, Double English. Assorted	1.00	8.00
Daisy, Paris Golden. Single yellow	3.50	25.00
Daisy, Paris White. Single white	3.50	25.00
Feverfew, Double White	2.00	15.00

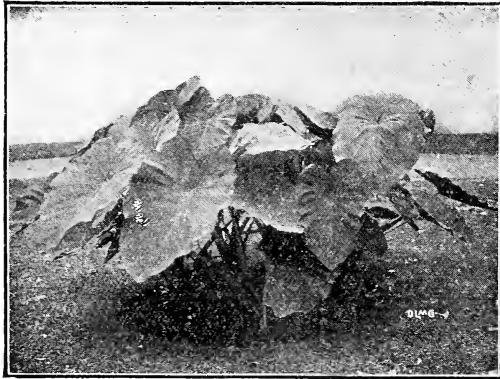

Caladium esculentum

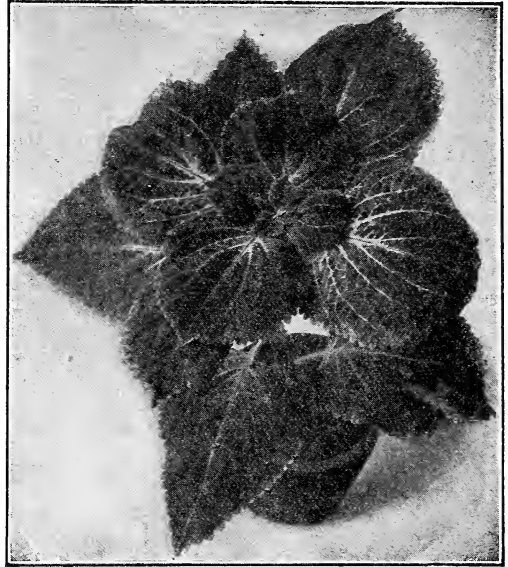

Coleus

	Doz.	100
Feverfew, Golden Feather	\$1.50	\$10.00
Fuchsias. In variety	3.50	25.00
Geranium, Double Varieties	3.00	22.00
Geranium, Single Varieties	3.00	22.00
Geranium, Ivy-leaved Sorts	3.00	22.00
Geranium. Variegated foliage	2.75	22.00
Heliotropes. Dark and light	2.50	18.00
Hollyhock, Double. Assorted	2.50	18.00
Hollyhock, Single. Assorted	2.50	18.00
Lantanas. In variety	2.00	15.00
Lobelia. Dark blue, for bedding	1.50	10.00
Marigold. Dwarf French	1.50	10.00
Mignonette, Large-flowered	1.25	8.00
Nasturtium, Dwarf. Assorted	1.50	10.00
Pansy. Special strain, extra choice85	6.00
Petunia, Double. Assorted colors	2.50	18.00
Petunia, Single. Assorted colors	1.50	12.00
Phlox Drummondii. Assorted	1.50	12.00
Ricinus (Castor Oil Bean)	2.00	15.00
Salvia splendens. Best scarlet	2.00	15.00
Verbenas. Assorted colors	1.50	10.00
Verbena. Lemon-scented	2.50	18.00
Vinca alba and rosea (Flowering Vinca) ...	1.50	12.00
Vinca Variegata (Periwinkle). Trailing ...	3.00	20.00
Zinnia, Columbia Prize. Assorted	1.25	10.00

Many other varieties not mentioned in this list can be furnished at regular prices



Select List of Hardy Perennial Plants

We would recommend those who have never undertaken the culture of hardy plants to commence with a few varieties most easily grown, and gradually increase their collections from season to season, and our word for it, it will lead to a confession that there is nothing in the way of bedding-out or ribbon gardening which can compare in any way to the beauty and refined charm of this class of plants. We can furnish a good selection of hardy plants, which may be expected to give successional bloom throughout the Spring, Summer and Fall months, and, if the choice is left to us, will take special care to select such varieties as afford the most satisfactory results.

Our connections with the best and leading nurseries in this country put us in a position to furnish the very best of all hardy nursery stock. We also furnish estimates on the laying out, planting and improvement of private estates, and furnish experienced gardeners to carry out the work. We shall be pleased to correspond with those contemplating improvements or planting hardy stock of any sort.

Any sorts not listed can be furnished at lowest prices

	Each Doz.	Each Doz.
ACANTHUS (Bear's Breech). A distinct class of plants with strong, broad foliage.		
<i>mollis</i> . 3 ft. Deep-toothed, heart-shaped leaves. July and August.....	\$0.35	\$3.50
ACHILLEA (Milfoil or Yarrow).		
<i>Perry White</i> . 20 in. New variety, June to Sept.....	.35	3.00
<i>ptarmica fl. pl. var., The Pearl</i> . Double white flowers, most useful for cutting. June to Oct.....	.35	3.00
<i>millefolium roseum</i> . 18 in. Broad, flat heads of pink flowers. July to Oct.....	.35	3.00
ACONITUM (Monkshood). A stately group of plants for borders and shady places.		
<i>autumnale</i> . 4 ft. Blossoms from September until frost; large spikes of dark blue flowers; excellent for planting in shady spots.....	.50	5.00
<i>Spark's Variety</i> . 4 ft. An early blooming sort with deep blue flowers and branching habit. July.....	.45	4.00
ACTAEA spicata alba (Baneberry). A choice hardy plant having dense spikes of pure white flowers followed by white berries. June and July.....	\$0.35	\$3.00
<i>spicata rubra</i> . Same as above but having bright red berries.....	.35	3.00
AGROSTEMMA (Rose Campion). Excellent and showy plants for borders.		
<i>coronaria</i> . 2 ft. Single white flowers. June to Aug.....	.30	2.50
<i>flosjovis</i> . 2 ft. Single bright rose-colored flowers. June to July.....	.30	2.50
AJUGA reptans (Bugle Plant). 6 in. Blue. Excellent for rockwork, covering banks and shady places. May.....	.30	2.50
ALYSSUM rostratum . Bright golden yellow flowers; splendid for masses; likes the sun; June and July. 1 ft.....	.30	2.50

PARCEL POST—Add six cents for one plant, two cents for each additional plant.

Hardy Perennial Plants—Continued

	Each	Doz.
ALYSSUM saxatile compactum (Basket of Gold). 1 ft. A grand plant for the rockery or border. April to June.....	\$0.35	\$3.00
ANCHUSA italica, Dropmore Variety. 3 to 4 ft. A lovely shade of gentian blue, and blooms the entire season.....	.30	3.00
ANEMONE japonica rubra (Windflower). 2 to 3 ft. Flowers of medium size, color rose; stamens yellow. Sept to Nov.....	.35	3.50
japonica alba. 2 to 3 ft. Flowers large, white. One of the best. Sept to Nov.....	.35	3.50
japonica, Geante Blanche. 2 ft. The finest white. Aug. to Oct.....	.35	3.50
japonica, Kriemhilde. 2 to 3 ft. Large semi-double, free-flowering; soft pink flower. Aug. to Oct.....	.35	3.50
japonica, Queen Charlotte. 2 ft. Large, semi-double, silvery pink. Sept.....	.35	3.50
japonica, Whirlwind. 2 to 3 ft. Large, semi-double, pure white. Sept.....	.40	3.50
rosea. The old original pink variety, still a favorite.....	.35	3.50
ANTHEMIS tinctoria (Golden Marguerite). 2 to 3 ft. Flowers lemon-yellow. Excellent for cutting. June to Oct.....	.30	3.00
AQUILEGIA (Columbine). Every garden should have these in its collection.		
Long-spurred Hybrids. 2 ft. These embrace all the colors of the long-spurred type, including plants grown from seed of the Scott-Elliott strain. May to July.....	.30	3.00
formosa truncata. 1 to 2 ft. Large flowers with scarlet sepals and bright yellow flowers.....	.30	3.00
chrysantha (Golden). 2 to 3 ft. Yellow long-spurred flowers. May to Aug.....	.30	3.00
caerulea (Rocky Mountain Blue Columbine). 2 ft. Long spurs, blue and white flowers. May to July.....	.30	3.00
caerulea alba. 2 ft. Long spurs, large white flowers. May to July.....	.30	3.00
haylodgensis. 2 ft. Long-spurred hybrids in shades of blue. May to July.....	.30	3.00
nivea grandiflora. Large pure white; very fine.....	.30	3.00
ARABIS alpina (Rock Cross). 6 in. One of the finest early white Spring-flowering plants. For rockwork and borders. April to June.....	.30	3.00
ARMERIA maritima laucheana (Sea Pink or Thrift). 1 ft. A fine plant for rockeries or edgings; flowers bright pink.....	.30	3.00
ASCLEPIAS tuberosa (Butterfly weed). One of the showiest of our native flowers; brilliant Orange. June to July.....	.35	3.50
ASTER (Michaelmas Daisies). These are our most showy Fall flowers.		
Amos Perry. 3 ft. Large deep pink.....	.50	5.00
Climax. Light lavender blue.....	.40	4.00
Feltham. Blue with yellow center.....	.40	4.00
Glory of Colwall. 4 ft. Double pale lavender; strong grower.....	.50	5.00
novae-angliae. 4 ft. Bright violet-purple.....	.30	3.00
novae-angliae alba. 4 ft. Pure white.....	.30	3.00
Loreley. 4 ft. An extra fine white variety.....	.50	5.00
BAPTISIA australis (False Indigo). 2 ft. Long racemes of dark blue flowers. June to July.....	.30	3.00
BOCCONIA cordata (Plume Poppy). 4 to 8 ft. White flowers with fig leaf foliage; very effective.....	.30	2.50

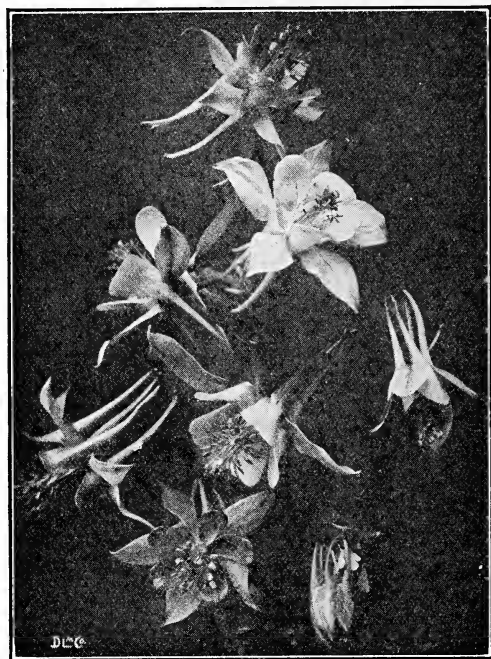

Aquilegia, Long-spurred Hybrids

	Each	Doz.
BOLTONIA asteroides (False Chamomile). 5 to 6 ft. Fine late-flowering perennials. Aster-like white flowers. Aug. to Sept.....	\$0.30	\$3.00
latisquama. 4 to 5 ft. Flowers clear lavender; fine for cutting.....	.30	3.00
CALLIRHOE involucreta. Poppy Mallow. Showy trailing Mallow, crimson.....	.35	3.50
CAMPANULA carpatica. 9 in. Erect blue flowers, useful for edgings. June to Sept.....	.30	3.00
carpatica alba. 9 in. Pure white.....	.30	3.00
medium (Canterbury-bells). 3 ft. Biennial. Flowers blue, white and rose. Separate colors.....	.30	3.00
medium calycanthema. Biennial. Flowers blue, rose and white, separate colors.....	.30	3.00
persicifolia. Peach-leaved. 2 ft. Blue. June to Aug.....	.30	3.00
persicifolia alba. 2 ft. White. June to Aug.....	.30	3.00
pyramidalis (Chimney Bell Flower). 4 ft. Blue. July to Sept.....	.35	3.50
rotundifolia (lue Bells). 1 ft. Blue.....	.30	3.00
trachelium (Coventry-bells). 3 ft. Purple; one of the best. June to Aug.....	.30	3.00
CARNATIONS, Hardy Garden Varieties. Excellent for cut flowers; somewhat smaller than the greenhouse sorts.....	.30	3.00
CASSIA marylandica (American Senna). 3 ft. Racemes of yellow flowers. July to Sept.....	.30	3.00

PRICES SUBJECT TO CHANGE WITHOUT NOTICE

	Each	Doz.
CENTAUREA montana. 20 in. Large purple flowers. Fine for cutting. June.....	\$0.30	\$3.00
montana alba30	3.00
CERASTIUM tomentosum (Snow-in-summer). 5 to 6 in. Low growing plant. Silvery foliage, white flowers; fine for rockeries.....	.30	3.00
CHELONE lyoni (Turtlehead). 2 ft. Showy deep red flowers, bearing snapdragon-like blooms and spikes. August to September.....	.30	3.00
CHRYSANTHEMUMS, Hardy. Flowering very freely in the Autumn, excellent for cutting and one of the last to be cut down by frost. Sept. to Nov. The following sorts (1½ to 3 ft.):		
Brown Bessie. Bronze. Small flowered....	.25	2.50
Cerise Queen. Deep cerise; small flowered.....	.25	2.50
Dundee. Dark Red.....	.25	2.50
Elkton. Light Pink.....	.25	2.50
Excellence. Dark red, very double.....	.25	2.50
Excelsior. Rich golden yellow.....	.25	2.50
Golden West. Yellow. Small flowered....	.25	2.50
Irene. Pearl-white with open yellow center.....	.25	2.50
James Boone. Pure white, small flowered.....	.25	2.50
Lady Naylor. White, shading to yellow....	.25	2.50
Leslie. Rich buttercup yellow.....	.25	2.50
Mrs. Peary. Pure white.....	.25	2.50
Seven Oaks. Large double yellow.....	.25	2.50
Sir Michael. Lemon-yellow.....	.25	2.50
Triomphe d'Or. Rich golden yellow.....	.25	2.50
Viola. Violet-crimson.....	.25	2.50
Windlass. Rich orange-yellow.....	.25	2.50
CHRYSANTHEMUM, Burbank's Shasta		
Daisy. 1½ ft. Large snow-white flowers; blooms all Summer.		
King Edward VII. Large pure white.....	.35	3.50
Triumph. Gigantic white flowers.....	.35	3.50
COREOPSIS. One of the best blooming all-Summer plants we have.		
Lanceolata grandiflora. 2 ft. Large golden yellow.....	.30	3.50
DELPHINIUM (Larkspur). Attractive group of perennials and a grand addition to the garden; by removing the first flower stems after the flowers are faded, a second crop will be thrown up.		
belladonna. 3 ft. Sky blue.....	.35	3.75
bellamosum. 3 ft. Dark blue.....	.30	3.00
chinensis. 2 ft. Gentian blue. Blooms all Summer.....	.30	3.00
chinensis album. 2 ft. White. Blooms all Summer.....	.30	3.00
Hollyhock Strain (Wrexham). A new giant race, double and semi-double. Many new and lovely shades. Mixed.....	.90	9.25
Hybrid Seedlings. 3 to 4 ft. All colors....	.35	3.00
DIANTHUS (Garden Pinks). A valuable and showy border plant; single and double. Very fragrant and bloom from May to Aug.		
barbatus (Sweet-william). 1 to 1½ ft. Mixed vars. June and July.....	.30	3.00
Pink35	3.50
Red30	3.00
White30	3.00
plumarius. 1 ft. Single, pink and white.....	.30	3.00
plumarius, Double Varieties (Clove or Spice Pinks).		
Brilliant. Deep pink.....	.40	3.50
Gregory. Light pink.....	.40	3.50
Glen Valley. Rosy pink, carmine eye.....	.40	3.50
Lilac Queen. Lavender-pink.....	.40	3.50

DICENTRA, or Dielytra (Bleedingheart). Each Doz.		
spectabilis. 2 ft. An old-fashioned favorite. May and June.....	\$0.75	\$7.50
DICTAMNUS fraxinella (Gas Plant). 2½ ft. Rosy crimson, fragrant foliage. May to July.....	.40	4.25
DIGITALIS (Foxglove). The broad foliage and showy spikes of bloom give a fine effect. June and July.		
grandiflora. 2½ ft. A yellow-flowered variety; hardy; fine for partial shade....	.30	3.00
purpurea. 2½ ft. Purple.....	.30	3.00
purpurea alba. 2½ ft. White.....	.30	3.00
purpurea rosea. Pink.....	.30	3.00
Spotted Varieties in various shades; very attractive.....	.30	3.00
ECHINOPS ritro (Globe Thistle). Showy thistle-like plants with metallic-blue globular flowers, beautiful shade. July to September. 3 ft.....	.30	3.00
sphaerocephalus (Globe Thistle). White flower heads. July to Sept. 6 ft.....	.30	3.00
EPILOBIUM angustifolium (Willow Herb). 4 ft. Purplish rose; adapted for low ground; flowering nearly all Summer.....	.30	3.00
ERYNGIUM amethystinum (See Holly). 2½ ft. Lovely amethyst blue flowers and finely cut spiny foliage; June to Sept.....	.30	3.00
planum. A lovely Sea Holly, with dainty pale blue flowers; valuable for cutting....	.30	3.00
EUPATORIUM ageratoides. (Thoroughwort). 3 ft. White flowers in dense heads; August to Sept.....	.30	3.00
coelestinum. Showy variety with light blue flowers similar to the Ageratum. August and September. 2 ft.....	.30	3.00
fraseri. Delicate white flowers in large terminal heads; useful for cutting. Aug. to Oct. 2 ft.....	.30	3.00

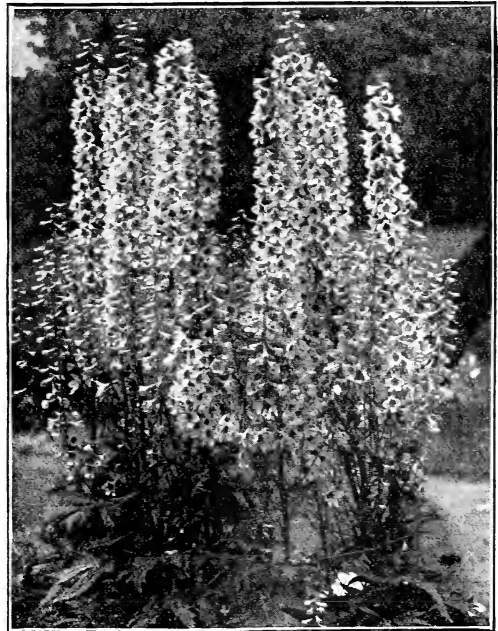

Delphinium



Gaillardia

	Each	Doz.
FERNS, HARDY. Can supply many hardy varieties.....	\$0.35	\$3.50
FUNKIA (Plantain-lily). A beautiful class of plants growing well in partial shade.		
coerulea. 1½ ft. Flowers blue, leaves broad. July.....	.30	3.00
subcordata grandiflora (White Day-lily). 2 ft. A pure white trumpet flowered and fragrant species. July to Sept.....	.60	6.00
undulata variegata. 1 ft. Beautiful variegated foliage, flowers lilac.....	.30	3.00
GAILLARDIA grandiflora (Blanket-flower). 2 ft. Large crimson and gold; good for cutting. June to Nov.....	.30	3.00
GYPSOPHILA paniculata (Babysbreath). 2 ft. An old-fashioned favorite; very useful, high-colored flowers. June to Aug....	.30	3.00
repens (Creeping Chalk Plant). 6 ft. Pale pink. June and July. Trailing in habit...	.30	3.00
HELENIUM autumnale rubrum. 5 ft. Reddish brown, Aster-shaped flowers; profuse bloomer. Aug. to Oct.....	.40	4.00
autumnale superbum. 5 ft. Immense heads of deep golden yellow flowers. Aug. to Oct.....	.30	3.00
autumnale. 4 ft. Flowers in large clusters of a deep golden yellow. Suitable for planting in borders of shrubbery. Aug. to Sept.	.30	3.00
hoopesi. 2 ft. Orange-yellow flowers; a very desirable border plant. June and July	.30	3.00
HELIANTHUS (Sunflower). These form a very important group of bold, showy Autumn flowering plants. Indispensable for large borders and woodland walks.		
maximiliana.30	3.00
mollis.30	3.00
Miss Mellish. 6 ft. Large, single, golden yellow. Sept. and Oct.....	.30	3.00
Miss Willmott. Large, single, clear yellow flowers. Sept. to Oct.....	.30	3.00
multiflorus fl. pl. 4 ft. Deep yellow double Dahlia-like flowers. One of the best for cutting. Protect in Winter, July to Oct.....	.35	3.50

	Each	Doz.
HELIOPSIS pitcheriana (Ox-eye). 3 ft. Very desirable, blooming all through the Summer. Deep orange yellow.....	\$0.30	\$3.00
HEMEROCALLIS (Day-lily). One of our most valuable flowers for the border; sweet scented. Also does well in partial shade and moist places.		
Apricot. Fine orange yellow, large and free flowering, June and July. 2½ ft.....	.35	3.50
flava. 3 ft. Golden yellow; very fragrant May and June.....	.35	3.50
fulva (Tawny Day-lily). 2 to 3 ft. Orange. July and Aug. Handsome flowers.....	.35	3.50
middendorffii. Bright yellow. June. 1½ to 2 ft.....	.30	3.00
thunbergi. Very fragrant flowers lemon-yellow, blooms in late spring. A fine variety.....	.35	3.50
HESPERIS matronalis (Sweet-rocket). 3 ft. Fragrant purple flowers in spikes. One of the oldest garden flowers. June and July	.30	3.00
matronalis alba. 3 ft. Flowers pure white. June to July.....	.30	3.00
HEUCHERA sanguinea. 1½ ft. Graceful spikes of delicate coral-red flowers. June and July.....	.30	3.00
HIBISCUS, Crimson Eye (Mallow). 4 ft. Large, pure white, with crimson spot in center. July and Aug.....	.30	3.00
moscheutos roseus. 4 ft. Showy pink flowers. July and Aug.....	.30	3.00
moscheutos albus. 4 ft. Pure white; very showy. July and Aug.....	.30	3.00
HOLLYHOCKS. Finest double variety. Separate colors or mixed.....	.30	3.00
Double Sensation. Large salmon-pink..	.35	3.50
Finest Single Varieties.30	3.00
IBERIS sempervirens (Candytuft). 1 ft. Evergreen foliage; good for borders. May and June.....	.30	3.00



Hemerocallis flava

PRICES SUBJECT TO CHANGE WITHOUT NOTICE

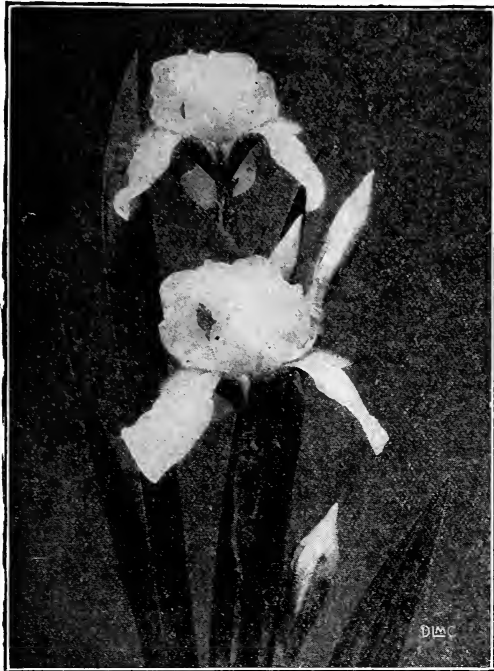

Iris germanica

IRIS germanica (Garden Iris). They form a group unparalleled in beauty. Every shade of color may be found among them, and they will thrive in almost any soil or situation.

30c. each, \$3.00 per doz., \$18.00 per 100.

Bronze Beauty. Sulphury-bronze.

Dr. Bernice. Coppery-bronze.

Elizabeth. Pale blue, passing to gray.

Florentina. Alba. Creamy white flushed lavender.

Fro. Deep gold. Each 35c., doz. \$3.50.

Lohengrin. Cattleya-rose color.

Madame Chereau. White, frilled azure-blue.

Mrs. H. Darwin. White.

Pallida dalmatica. Soft lavender.

Powhatan. Rosy violet. Each 40c., doz. \$4.00.

Princess Victoria Louise. Sulphur-yellow. Each 35c.

doz. \$3.50.

Rhein Nixe. White.

Trautlieb. Soft rose. Each 35c., doz. \$3.50.

IRIS kaempferi (Japan Iris). These differ from the other Irises in having the blossoms broad and flat, like a Clematis; grows best in moist, rich soils.

50c. each, \$5.00 per doz., \$38.00 per 100.

Double Mixed.

Single Mixed.

Each Doz.

IRIS orientalis. 2 ft. Rich violet-blue June and July. \$0.30 \$3.00

orientalis, Snow Queen. 2 ft. Pure white; very free and fine. June and July. .30 3.00

pseudacorus. 4 ft. Fine foliage bright yellow; will grow well in ponds or border of water gardens. June and July. .30 3.00

pumila hybrida cyanea. Dwarf bright blue. Fine for edgings. .30 3.00

sibirica. 3 to 4 ft. Foliage and flower stems slender, useful for cutting. June. .30 3.00

sibirica alba. 3 to 4 ft. Flowers white. .35 3.50

	Each	Doz.
LATHYRUS latifolius (Everlasting Pea). 5 ft. Flowers large, bright red. July to Aug.	\$0.30	\$3.00
LAVANDULA vera. True lavender. 2 ft. Fragrant bluish flowers; foliage gray, with fragrance of lavender.	.40	4.00
LIATRIS pycnostachya (Blazing Star). 4 ft. Showy spikes of rosy-purple flowers. July to Sept.	.30	3.00
LILY-OF-THE-VALLEY. Strong clumps. Doubtful if we can supply.	.60	6.00
LINUM perenne. 18 in. Light blue flowers, which are produced all Summer.	.30	3.00
perenne alba. 18 in. A white form; very free flowering.	.30	3.00
LOBELLA cardinalis (Cardinal-flower). 3 ft. Cardinal-red. Aug. to Oct.	.30	3.00
LYCHNIS chalcidonica (London Pride). 3 ft. Brilliant heads of crimson flowers. June to Sept.	.35	3.50
haageana. 1 ft. A very showy perennial; brilliant scarlet. June and July.	.35	3.50
viscaria. 1½ ft. Single scarlet flowers, brilliant. July and Aug.	.35	3.50
LYSIMACHIA nummularia (Moneywort). Flowers 2 inches. Excellent to cover bare spots in shady places. Yellow flowers. June to Oct.	.30	3.00
LYTHRUM rosem superbum. 3 ft. Spikes of deep rose-colored flowers. Sept.	.30	3.00
virgatum. Extremely attractive flowers of rich rosy-purple borne on erect stalks. Blooms from July to Sept. 2½ ft.	.30	3.00
MENTHA piperita (Peppermint). 1 to 2 ft. Purplish. Aug.	.30	3.00
MONARDA didyma (Oswego Tea). 3 ft. Aromatic foliage and bright scarlet flowers. June to Sept.	.30	3.00
mollis. Lilac.	.30	3.00
MYOSOTIS palustris (Forget-me-not). 10 in. Flowers all Summer. Fine blue.	.30	3.00
NEPETA mussini. Dwarf, covered with light blue flowers. Fine for rock garden. May to Sept.	.35	3.50
OENOTHERA (Evening Primrose).		
fruticosa major. Large golden yellow flowers. July. 2 ft.	.30	3.00
youngi. 18 in. Bright yellow. June to Sept.	.30	3.00



Myosotis

PRICES SUBJECT TO CHANGE WITHOUT NOTICE

PAEONIES. One of the hardiest flowering plants and rivaled only by the Rose.	Each	
Alsace-Lorraine. White, much like the white pond-lily. Late variety.	\$2.50	
Couronne d'Or. Pure white globular flowers, with amber-yellow stamens, center petals tipped carmine.	1.00	
Dorchester. Large and compact. Pale hydrangea pink. Fragrant.	1.00	
Dorothy Allison. Bright, fresh pink; dwarf habit and blooms in midseason.	3.00	
Duchesse de Nemours (Calot). Medium-sized pure white bloom. Strong free bloomer.	.75	
Eugenie Verdier. Flesh pink, midseason. Extra fine variety.	1.50	
Felix Crousse. Large, globular bloom. Brilliant red and a free bloomer.	1.00	
Festiva Maxima. Very large; pure white center, petals tipped with bright crimson.	.75	
Georgiana Shaylor. Pale pink flecked with crimson; fine blooms late in the season.	4.00	
Ginette. A flesh pink variety, very fragrant. Early	3.00	
James Kelway. A pure white variety, blooms early midseason.	1.50	
Lady Alexandra Duff. Blush pink to white, midseason.	2.00	
Le Cygne. Pure milk white incurved petals, midseason.	7.00	
Madame de Verneville. Very large; pure white with center petals blush, tipped carmine.	.75	
Monsieur Jules Elie. Large, compact. Pale lilac-rose with silvery reflex; fragrant.	1.50	
Norfolk. Deep shell-pink with cup-shaped petals. Late blooming.	1.00	
Venus. Delicate shell-pink compact bloom.	1.50	
Walter Faxon. Large blooms; bright rose deepening toward the center; fragrant.	3.50	
PAEONIA officinalis, alba, rubra, rosea	1.00	
	Each	Doz.
PAEONIAS, Mixed	\$1.00	\$10.00
PAPAVER orientale (Oriental Poppy). 3 ft. Brilliant scarlet with black center; very showy. June.	.30	3.00



Phlox



Paeonia Festiva Maxima

PARDANTHUS sinensis (Blackberry-lily. Each Doz. 2½ ft. Orange. July and Aug.	\$0.30	\$3.00
PENTSTEMON barbatus torreyi (Beard-tongue). 4 ft. Bright scarlet flowers. July to Sept.	.30	3.00
digitalis. 3 ft. Pure white. July and August	.30	3.00
PHLOX decussata (Hardy Perennial Phlox). 35c. each, \$3.50 per doz., except where noted.		
Alpha. Brilliant rosy pink, long trusses.		
Annie Cook. Flesh pink.		
Astrild. Clear large red.		
B. Comte. French purple.		
Dantons. Light madder, maroon eye.		
Deutschland. A rich scarlet variety.		
Elizabeth Campbell. Light salmon.		
Enchantress. Salmon pink.		
Europe. White; decided crimson eye.		
Francee. Pure white.		
Frau Antoine Buchner. Largest pure white.		
Jeanne d'Arc. Pure white; late.		
Johnson's Favorite. Light salmon-pink. Red eye.		
Le Caid. Pink; darker eye.		
Lord Raleigh. Purple, white markings.		
Maid Marion. Soft lavender large flower.		
Miss Lingard. White with pale pink center. Early.		
Mrs. Jenkins. Beautiful clear white.		
Mrs. Scholton. Salmon-scarlet.		
Pantheon. Brilliant rose, very effective.		
Peachblow. Pale pink, lighter edge.		
Rheinlander. Beautiful salmon-pink.		
Rijnstroom. Color of Paul Neyron rose.		
Selma. Pale lavender.		
Sir Edwin Landseer. Flowers bright crimson.		
Special French. Beautiful clear pink.		
Thor. Deep salmon-pink.		
W. C. Egan. Delicate lilac, reddish eye.		
PHLOX amoena. 4 to 6 in. Forming a carpet of foliage covered in May and June with a sheet of bright pink flowers.	\$0.30	\$3.00
divaricata. 1. ft. Dwarf. Pale blue. Native variety. May and June.	.30	3.00
subulata (Moss Pink). 4 to 6 in. Pink. April and May.	.30	3.00
subulata alba. 4 to 6 in. White.	.30	3.00
subulata var. lilacina. Light lilac.	.30	3.00

PRICES SUBJECT TO CHANGE WITHOUT NOTICE

	Each	Doz.
PHYSOSTEGIA virginica (False-dragon-head). One of the most attractive Mid-summer plants, covered with clear pink, heath-like flowers. July and Aug.	\$.30	\$3.00
PLATYCODON grandiflorum (Wahlenbergia). 2½ ft. Large blue, Campanula-like flowers. July to Oct.30	3.00
grandiflorum album . 2½ ft. White.30	3.00
mariesi . 1½ ft. Violet-blue.30	3.00
POLEMONIUM coeruleum (Jacobs-ladder). 2 ft. Light blue. May to July.30	3.00
PRIMULA vulgaris (English Primrose). Bright canary-yellow. April and May.30	3.00
PYRETHRUM roseum (Persian Daisy). 2 ft. One of the showiest flowers; of great value for cutting. June to July. Single Mixed.30	3.00
uliginosum (Giant Daisy). 4 ft. Large white. Aug. and Sept.35	3.50
RANUNCULUS acris fl. pl. (Double Buttercup). 2 ft. Double yellow. May and June	.30	3.00
RUBECKIA (Autumn Sun) . 5 to 6 ft. Bright yellow giant flowers. Sept and Oct.	.30	3.00
lanceolata (Goldenglow). 5 to 6 ft. Double yellow, Cactus-Dahlia-like flowers. July to Sept.30	3.00
newmanni . 2½ ft. Golden yellow with purple cone. July to Oct.35	3.50
purpurea . 3 ft. Large, reddish purple, with dark, cone-shaped center of brown. July to Oct.30	3.00
SALVIA pratensis . 2 to 3 ft. Spikes of rich blue flowers. June to Sept.30	3.00
SAXIFRAGA maenabiana . Long, graceful sprays of white flowers spotted crimson.30	3.00
SCABIOSA caucasica . A soft and pleasing shade of lavender. June to Sept.40	4.00



Pyrethrum



Spiraea aruncus

SEDUM acre (Golden-moss). 4 in. Bright yellow, with green foliage. May to July.	\$.30	\$3.00
album . 4 in. Green foliage, white flowers. July and Aug.30	3.00
sexangulare . Dark green foliage. Yellow flower. 6 in.30	3.00
sieboldi . 9 in. Glaucescent foliage and bright pink flowers. Aug. and Sept.30	3.00
SPIRAEA aruncus . 3 ft. White, June.45	4.50
filipendula (Dropwort). Clusters of large white flowers. 1½ ft. May and June.35	3.50
filipendula fl. pl. 2 ft. Double white, June and July.50	4.50
palmata . 3 ft. Rosy crimson. June to Aug.50	4.50
STATICE latifolia (Sea Lavender). 1½ ft. Violet-blue. July to Sept.35	3.50
STOKESIA cyanea (Cornflower Aster). 2 ft. Lavender-blue. A native plant; fine for cutting. July to Oct.30	3.00
alba30	3.00
TRITOMA uvaria grandiflora (Flameflower). 4 ft. Orange-scarlet. Aug. to Nov.35	3.50
TROLLIUS europaeus (Globeflower). 1½ ft. Bright yellow. June to Sept.50	5.00
ledebouri . Fine variety, rich, golden yellow	.60	5.00
VERONICA amethystina (Speedwell). 1 ft. Amethyst blue. May to July.30	3.00
repens . Trailing variety. Flowers light blue, fine for rockeries.35	3.50
spicata . 2 ft. Blue. June to Aug.30	3.00
Vinca minor (Myrtle). Creeping evergreen; good for covering ground in shady places. Bright blue flowers. April to July.30	3.00
VIOLA cornuta (Tufted Pansies). 6 in. Profuse bloomers from April to frost.30	3.00
cornuta alba . White. 6 in.30	3.00
cornuta var. purpurea . Deep Violet-blue. Very free flowering.30	3.00
Jersey Gem . Rich violet color, fragrant; fine for borders or rockeries.40	4.25

PRICES SUBJECT TO CHANGE WITHOUT NOTICE

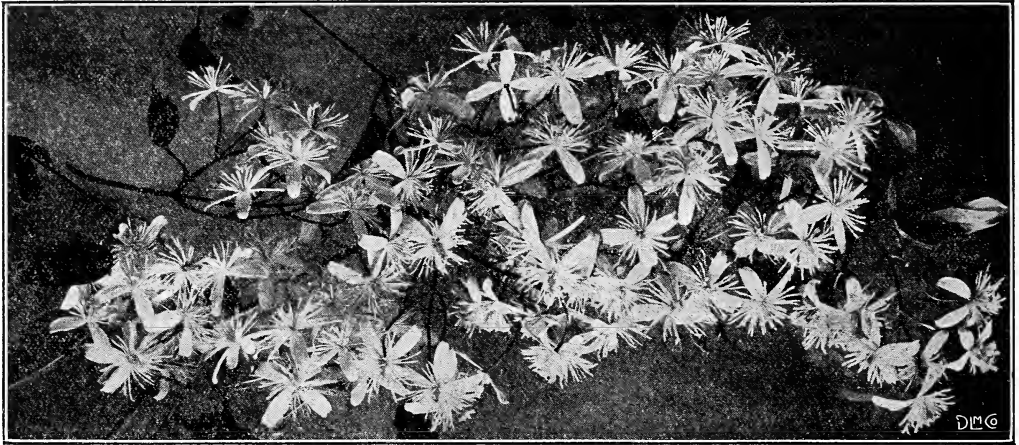

Clematis

Hardy Climbing Plants and Flowering Vines

Embracing the most beautiful sorts of vines and creepers, suitable for trailing or climbing on verandas, trellises, walls, fences, etc.

	Each	Doz.		Each	Doz.
ACTINIDIA arguta. Oval, glossy leaves and clusters of fragrant flowers.....	\$1.25	\$12.00	ENGLISH IVY (<i>Hedera Helix</i>). A very desirable evergreen climber, succeeds best in a sheltered shady situation.....	\$1.00	\$10.00
AKEBIA quinata. Clover-like leaves and fragrant, velvety purple flowers.....	1.00	10.00	EUONYMUS radicans. An evergreen, glossy-leaved vine, valuable for covering wood to which it clings.....	.50	5.00
AMPELOPSIS quinquefolia (Virginia Creeper). Rapid grower.....	.50	5.00	radicans acutus. A strong grower, forms a dense mat of very deep green.....	.75	7.50
engelmanni. A creeper that slings to stone or wood as tightly as English Ivy.....	.50	5.00	radicans vegetus. The leaves are large and of a rich, glossy green; it is of more rapid growth than the others.....	.60	6.00
tricolor, or Vitis heterophylla (Variegated Grape). Pretty vine with white, pink and green marbled foliage.....	1.00	10.00	LONICERA (Honeysuckle). Old favorites, shrubby climbers, fine for porches and trellises. Very fragrant.		
veitchi (Japanese Ivy). Very fine for covering walls, rocks, etc.....	.60	6.00	Hall's Japan. Fragrant, yellow and cream-colored flowers all Summer.....	.60	6.00
ARISTOLOCHIA siphon (Dutchmans-pipe). Heart-shaped leaves; the brown flowers resemble a pipe.....	1.25	12.00	Golden Variegated. Green and gold variegated foliage, variety of preceding... ..	.60	6.00
BIGNONIA radicans (Trumpetflower). Large trumpet-shaped, orange and red flowers.....	.60	6.00	Scarlet Trumpet. Clusters of tubular scarlet flowers all Summer.....	.75	7.50
CELASTRUS orbiculatus (Japanese Bittersweet). A strong climbing shrub with glossy green foliage, and in Autumn covered with bright yellow fruit.....	.75	7.50	HOP VINE. Vigorous and quick growing twiner for covering arbors, etc.....	.50	5.00
scandens (Roxbury Waxwork). Glossy leaves and clusters of orange-erimson fruit, which remain on all Winter.....	.75	7.50	LYCIUM chinense (Matrimony-vine). A climbing shrub with light green foliage and pale purple flowers; fine for northern exposures.....	.50	5.00
CLEMATIS paniculata. Glossy, dark green foliage, and covered in the latter part of the Summer with star-like white flowers, so fragrant that the delicious odor can be detected at a long distance.....	.50	5.00	POLYGONUM auberti (Silver Lace Vine). A very strong growing decorative climbing plant, staying in bloom through the Summer and Autumn. The flowers are in large sprays of pure white.....	1.75	17.00
Extra large.....	.75	7.50	WISTERIA sinensis (Chinese Wisteria). Long, pendulous clusters of pale blue flowers.....	1.50	15.00
henryi. One of the best whites; very large white flowers often as much as 8 inches across. A continuous bloomer.....	1.50	15.00	sinensis alba. White-flowered variety of preceding.....	1.50	15.00
jackmani. Large violet-purple; free bloomer. The petals of this variety are rather broad.....	1.50	15.00			
Mme. Andre. Large carmine-red flowers; very free bloomer.....	1.50	15.00			
ramona. Light blue.....	1.50	15.00			

PRICES SUBJECT TO CHANGE WITHOUT NOTICE

Roses

HARDY HYBRID PERPETUAL ROSES

Strong, 2-year-old plants; \$1.00 each, \$11.25 per doz., \$85.00 per 100, by express only.

- Alfred Colomb.** Bright, carmine-crimson, large and full.
American Beauty. Deep pink, shaded carmine.
Anna de Diesbach. Large, clear bright carmine.
Baroness Rothschild. Rich satiny pink; excellent.
Baron de Bonstetten. Dark red, almost black; large.
Beaute de Lyon. Copper yellow buds.
Captain Hayward. Brilliant carmine, sweet scented.
Clio. Flesh-color, rich pink center.
Duchess of Sutherland. Warm pink, tinted lemon.
Earl of Dufferin. Large velvety crimson.
Eugene Furst. Carmine red.
Fisher Holmes. Deep brilliant crimson.
Frau Karl Druschki. The finest white.
General Jacqueminot. Brilliant scarlet-crimson.
George Arends. Pointed petals, soft pink.
George Dickson. Very large, dark red.
Gloire Lyonnaise. Very double white.
Hugh Dickson. Crimson, shaded scarlet.
John Hopper. Large, rosy crimson; free.
Jules Margottin. Carmine-rose.
Juliet. Globular golden buds.
Leonie Lambert. Silver pink flowers, shaded yellow.
Ludwig Moller. Bright amber yellow.
Magna Charta. Bright pink and carmine.
Marguerite Guillard. Pure white, very large.
Mme. Albert Barbier. Soft fawn-yellow.
Mme. Gabriel Luizet. Beautiful satiny pink.
Mme. Victor Verdier. Cherry crimson.
Margaret Dickson. White, blush center.
Mrs. John Laing. Beautiful soft pink; large.



Rose Frau Karl Druschki

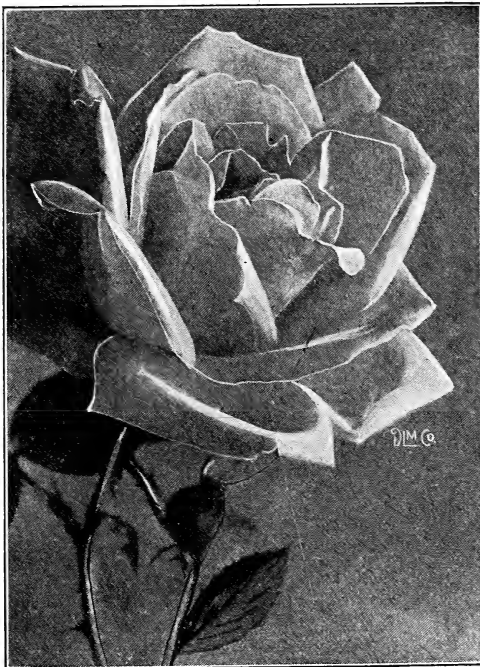

Rose Caroline Testout

- Mrs. R. G. Sharman-Crawford.** Deep pink, shaded.
M. P. Wilder. Cherry carmine.
Paul Neyron. Immense deep pink.
Prince Camille de Rohan. Crimson-maroon.
Soleil d'Or. Orange-gold and pink.
Ulrich Brunner. Large, bright cherry-red.
Vick's Caprice. Lilac-rose, striped white.

TEA AND HYBRID TEA ROSES

We offer the leading well-tested varieties, which have proved most satisfactory for garden and house culture. They can be wintered safely by covering 6 to 8 inches deep with light dry material.

Strong, 2-year-old plants; \$1.00 each, \$11.25 per doz., \$85.00 per 100

- Betty.** Coppery-pink suffused with gold.
Caroline Testout. Silvery salmon-pink.
Columbia. Large, clear pink; free bloomer.
Duchess of Wellington. Saffron-yellow, stained crimson.
Gruss an Teplitz. Bright crimson.
Kaiserin Auguste Viktoria. Delicate cream.
Killarney. Delicate pink.
Killarney Brilliant. Fine rosy red.
Killarney White. Pure white.
Lady Ashtown. Soft rose, yellow center.
La France. Silvery rose, shaded lilac.
Madame Butterfly. Bright pink, shaded apricot.
Madame Edouard Herriot (Daily Mail). Deep terracotta.
Madame Segond Weber. Soft salmon-pink.
Mrs. Aaron Ward. Rich yellow in bud, changing to exquisite shade of pink when fully open.
Radiance. Deep cerise-pink.
Sunburst. Orange-copper and golden yellow.

HARDY CLIMBING ROSES

\$1.00 each, \$10.00 per doz., unless noted.

- American Beauty.** Large crimson flowers.
American Pillar. Large, single, rich rosy pink, with bright yellow stamens.
Crimson Rambler. Immense clusters of double deepest crimson flowers. 75c. each.
Dr. W. Van Fleet. Semi-double delicate flesh-pink, glossy foliage.
Dorothy Perkins. Double, soft shell-pink. 75c. each.
Excelsa. Double crimson-red flowers.
Hiawatha. Intense crimson, single.
Lady Gay. Double, cherry-pink. 75c. each.
Paul's Scarlet. Vivid scarlet. \$1.25 each.
Silver Moon. Large pure white.
Tausendschon. Deep, rosy pink; large and double.
White Dorothy Perkins. Double pure white. 75c. each.
White Rambler. White, double, in clusters.
Yellow Rambler. Double, light yellow, in clusters.

MISCELLANEOUS HARDY ROSES

Strong plants; \$1.00 each, unless noted.

- Austrian, Harrison's Yellow.** Semi-double, golden.
Austrian, Persian Yellow. Double rich yellow.
Baby Dorothy (Maman Levasseur). The dwarf Dorothy Perkins. Fine pink.
Baby Rambler, Crimson (Mme. Nobert Levasseur). The dwarf crimson Rambler.
Baby Rambler, Cherry Pink (Mr. Wm. H. Cutbush). Very free flowering, double.
Baby Rambler, White (Katherine Zeimet). Dwarf, double pure white.
RUGOSA and HYBRIDS (Japanese Roses).
alba. Single pure white.
Blanc Double de Coubert. Double white.
Conrad Ferdinand Meyer. Double silvery pink.
F. J. Grootendorst (New Rugosa Rose). A cross between rugosa and Crimson Baby Rambler. Very hardy; fine for massing or hedge. Brilliant crimson blooms, continuing in flower very late in the Fall.
Roserie de l'Hay. Double carmine.
ruba. Single bright rosy crimson. \$1.10 each.



Baby Rambler Rose

MOSS ROSES

Well-known old-fashioned favorites.

- Blanche Moreau.** Choice white variety. \$1.00.
Crested Moss. Brilliant pink variety. \$1.00.

WICHURAIANA VARIETIES

(Trailing or Memorial)

- Specially suited for ground covering and banks or protruding rocks. Fine, glossy foliage, very free flowering.
Gardenia. Fine yellow. Each 75c.
Wichuriana. Single pure white. 75c. each.



Rosa Rugosa

Flowering and Ornamental Hardy Shrubs

This class of plants does more for our gardens and grounds, to make them look attractive and homelike, than all other classes combined. It gives us beautiful foliage of many kinds, flowers from April to November, and clothes the lawn with that abundance of branches and leafage which is so necessary to any feeling of seclusion or privacy in our home grounds.

	Each
ALTHAEA, Double. Handsome Hollyhock-like flowers of red, white and pink. Sept.	\$1.00
AMELANCHIER botryapium (Dwarf Juneberry). A hardy white flowering shrub. June. 3 to 4 ft.	1.00
AMORPHA fruticosa (Indigo Bush). A low growing, free flowering shrub, with numerous bluish flowers. Well adapted to rockeries. Doz. \$6.00.60
ARALIA pentaphylla. One of the best shrubs to plant on north and east side of buildings, also in shady places.75
AZALEA arborescens. Fragrant white Azalea, early flowering. 18 to 24 in.	3.00
24 to 30 in.	3.50
mollis. More dwarf and larger flowered than preceding. June. 18 to 24 in.	4.00
nudiflora (Pinxter Flower). Native, with deep pink fragrant flowers. May and June.	2.50
Vaseyi. Flowers pink, shading to violet. July.	3.00
BERBERIS thunbergi (Japan Barberry). Beautiful tinted foliage in the Autumn. June.60
vulgaris (European Barberry). Pendulous clusters of red berries. June.60
vulgaris purpurea. Deep purple foliage all Summer. June.60
BUDDLEIA variabilis magnifica. Intense violet purple with orange eye. Aug. and Sept.75
variabilis veitchiana. Flower-spikes 18 to 20 in. long. 3 in. across. Violet mauve.60
BUXUS (Boxwood) Bush Form. For window boxes or bordering walks. Owing to the restrictions on importations, Box plants are rather scarce. 12 in., \$2.50; 15 in., \$3.00; 18 in.	3.50
CALYCANTHUS floridus (Spice Bush). Deep chocolate-colored flowers of pineapple fragrance. June to Sept.	1.00
CEPHALANTHUS occidentalis (Button Bush). Grows well in moist ground, the picturesque blossoms remain all Summer as brown seed balls.75
CHIONANTHUS virginica (White Fringe). Delicate, fringe-like flowers, white. May.	1.50
CLETHRA alnifolia (Sweet Pepper Bush). Upright spikes of fragrant white flowers. July to Sept.75
CORCHORUS japonica fl. pl. (Kerria). Brilliant double, orange-yellow flowers. June and July.	1.00
CORNUS florida. Large, white flowering Dogwood. May. 3 to 4 ft. \$2.00, 4 to 5 ft.	2.50
florida rubra. Large, deep rose-colored flowers. May. 3 to 4 ft.	7.50
mas, or mascula (Cornelian Cherry). Attractive in early Spring with its yellow flowers and again in the Fall with shining scarlet fruit.75
stolonifera flaviramea. (Golden Twigged Dogwood). The bark is bright yellow during Winter, very pretty and striking when planted in a group.75

	Each
CYDONIA japonica (Japan Quince). Large, deep scarlet flowers, followed by large fruit.	\$1.00
DAPHNE cneorum (Garland Flower). An evergreen hardy spreading plant; flowers resembling the Mayflower. Very fragrant. May to Oct. 6 to 8 in. spread, \$1.25; 8 to 10 in. spread, \$1.50; 10 to 12 in. spread, \$2.00; 12 to 15 in. spread.	2.50
DEUTZIA crenata. (Pride of Rochester). Double white flowers, tinged with rose. June.60
crenata rosea. Very pretty shrub with double pink flowers. July.60
gracilis. Round, dense bush, covered with snow-white flowers. June.60
Lemoinei, New. Erect panicles of large snow-white flowers. June.60
ELAEAGNUS longipes. Ornamental and edible fruited shrub from Japan. July.	1.50
EUONYMUS americanus (Strawberry Bush). Deep scarlet berries. June.	1.00
alatus (Burning Bush). Bright, green foliage, turning in the Autumn to brilliant crimson-scarlet and covered with bright red fruit.	1.75
EXOCHORDA grandiflora. Chinese shrub, with clusters of pure white, starry flowers. May.75
FORSYTHIA Fortunei (Golden Bell). Pendulous, trumpet-shaped, yellow flowers. April.60
suspensa (Weeping Golden Bell). Weeping habit and showy yellow flowers. April.60
viridissima. Stiffer and bush-like habit. May.60

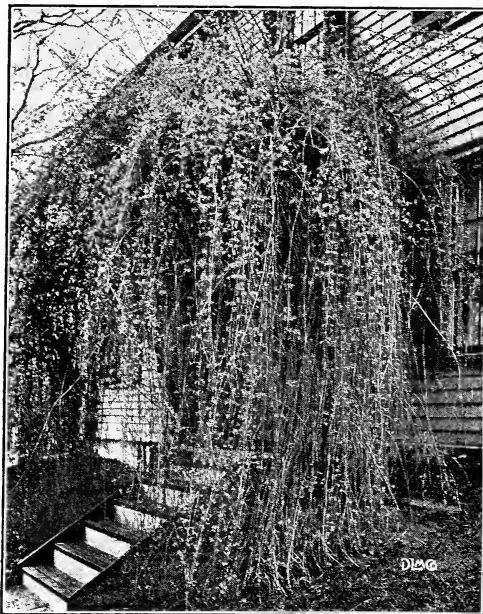

Forsythia suspensa

FLOWERING AND ORNAMENTAL HARDY SHRUBS—Continued

HYDRANGEA arborescens grandiflora (Snowball Hydrangea). Large, snow-white blooms from June to August.....	Each		VIRGINAL (Virginal Mockorange). One of the finest of these sweet scented shrubs. In June it is completely covered with double crested white flowers.....	Each	
paniculata . Thickly studded with heads of single white flowers. September.....		\$0.75	PRUNUS pissardi (Purple-leaved Plum). Bright purple foliage through the season.....		\$1.25
paniculata grandiflora . Immense, cone-shaped heads of white flowers, turning later to shades of pink and red. July to October.....		.60	triloba (Double-flowering Plum). Double pink flowers, like small Roses. May. 2 to 3 ft.....		1.50
		2.00	RHODODENDRONS, Hardest Hybrids . Fine collection of the best named sorts.....		21.00
ILEX verticillata (Black Alder). Glossy dark green foliage and bright crimson berries. The berries remain all Winter.....		.75	catawiense . A native close-growing form, with handsome foliage and large trusses of deep rose flowers.....		\$5.00 to 21.00
KALMIA latifolia . (Mountain-laurel) Glossy evergreen foliage and clusters of pink and white flowers. June. 18 to 24 in.....		3.50	maximum . Excellent for shady situations; flowers white and pink.....		\$5.00 to 7.00
LILAC, Common Purple . An old favorite; fragrant purple flowers. May. 3 to 4 ft. 75c. 5 ft.		1.25	Packing extra.		
Common White . Like preceding, with fragrant white flowers. 3 to 4 ft. 75c., 5 ft.		1.25	RHODOTYPOS kerrioides (White Kerria). Flowers white all Summer.....		.75
Charles the Tenth . Magnificent clusters of dark red flowers in great profusion.....		1.50	RHUS cotinus (Purple Fringe, or Smoke Tree). Purplish flowers. June.....		1.25
Jacques Calot . Single rose pink.....		1.75	RUBUS odorata (Flowering Raspberry). Large fragrant, reddish purple flowers all Summer.....		.60
Lamartine . Single rosy mauve.....		2.00	SPIRAEA, Anthony Waterer . Low-growing with flat heads of red flowers all Summer.....		.75
Ludwig Spaeth . Very large and of a splendid dark purple-red.....		1.75	opulifolia aurea (Golden Spiraea). One of the best yellow-leaved shrubs; flowers white. June.....		.60
Mme. Lemoine . Grand, double white variety, with large foliage.....		1.50	prunifolia fl. pl. (Bridal Wreath). Double, pure white flowers. May.....		.75
President Grey . Immense spikes of double cobalt-blue flowers, with rosy edges.....		1.75	Thunbergi . Low-growing, rounded form, with an abundance of white flowers. May.....		.60
Rubra de Marly . Flowers single rosy purple....		1.75	Vanhouttei . Graceful rounded form, covered with pure, white flowers. June. 2 to 3 ft.....		.60
LONICERA tatarica (Bush Honeysuckle). Profusion of sweet-scented pink flowers. May....		.75	SAMBUCUS nigra aurea (Golden Elder). A large golden-leaved shrub.....		.75
Tatarica alba . Pure white-flowered sort of the preceding. May.....		.60	SYMPHORICARPOS racemosus (Snowberry). Small pink flowers with large white berries....		.60
Bella albidia (White Honeysuckle). 3 to 4 ft.75	vulgaris60
Morrowi . Yellow flowers, followed by rich crimson fruit. All Summer.....		.60	VIBURNUM opulus (High-bush Cranberry). Cymes of white flowers in June, and bright scarlet berries into late Winter.....		1.00
Maacki . A tall variety.....		1.00	opulus sterilis (Common Snowball). Large, pendant balls, snow-white. May.....		.75
PRIVET (Ligustrum), California . Broad, oval-shaped leaves; white flowers. July. 3½ to 4 ft.40	plicatum (Japan Snowball). Superior to the preceding in foliage, which is plicated, also in flower, which is larger and whiter. May.....		1.25
European . Valuable hedge plant, with showy white flowers; very hardy. June.....		.50	tomentosum . Single form of the preceding, with massive cymes of blooms late in the Summer..		1.00
Ibota (Japan). Dark oval foliage, and racemes of white, fragrant flowers.....		.50	WEIGELA candida . Tubular white flowers all Summer.....		.75
PHILADELPHUS coronarius (Syringa, or Mockorange). Pure white fragrant flowers in clusters. June.....		.60	Eva Rathke . Large, deep crimson flowers from June to frost.....		1.00
coronarius aureus . Golden foliage. One of the best golden foliage shrubs. June.....		.75	floribunda . Deep crimson flowers. June.....		.75
Avalanche . Low growing shrub with weeping branches and pure white fragrant flowers. June.75	rosea . Fine rose-colored variety. June.....		.75
Lemoinei, Mont Blanc . Attaining 5 ft. in height, with erect branches entirely covered with large, fragrant flowers. June, 2 to 3 ft.60	rosea nana variegata . Silvery variegated leaves and pinkish white flowers. June.....		.75

Hedge Plants

ARBORVITAE globosa . 15 to 18 in. diameter. \$3.50 each, \$39.00 per doz.....	100	\$300.00	PHILADELPHUS coronarius	100	\$35.00
ARBORVITAE, American . 3 ft.		300.00	PRIVET, California . 12 to 18 in.		8.00
4 ft.		350.00	2 to 2½ ft.		10.00
BARBERRY, Japanese, or Thunbergi . 15 to 18 in.		15.00	3 to 3½ ft.		15.00
18 to 24 in.		25.00	Ibota . 1½ to 2 ft.		18.00
24 to 30 in.		36.00	2 to 3 ft.		22.00
JAPANESE QUINCE (Cydonia). 2 to 3 ft.		75.00	SPIRAEA, Golden . 3 to 4 ft.		45.00
LILAC, Common . Purple.....		70.00	Thunbergi . 2 to 3 ft.		45.00
White.....		75.00	Vanhouttei . 2 to 3 ft.		35.00
			3 to 4 ft.		40.00
			SPRUCE, Norway . 2 to 2½ ft.		225.00
			2½ to 3 ft.		300.00
			3 to 4 ft.		360.00

Ornamental Trees

DECIDUOUS TREES

ASH (Fraxinus)—

Mountain (*Sorbus aucuparia*). 6 to 8 ft., \$2.50; 8 to 10 ft. \$3.50.

BIRCH (*Betula*)—

Canoe (*B. papyrifera*). 8 to 10 ft. \$3.50.

Cut-leaved Weeping. 4 to 5 ft., \$3.00

BEECH (Fagus)—

American (*F. ferruginea*). 5 to 6 ft., \$3.50.

Purpurea. 12 to 14 ft., \$15.00.

CATALPA—

Bungei. 2 yr. heads, \$2.50.

speciosa. 8 to 10 ft., \$1.50.

CRATAEGUS (Hawthorn)—

Oxyantha (Common). 4 to 5 ft., \$1.25.

Cruss-galli (Cockspur Thorn). Long thorns, glossy foliage and bright fruit in Autumn. 4 to 5 ft., \$1.75.

ELM (Ulmus)—

American. 8 to 10 ft., \$2.75; 10 to 12 ft., \$4.00.

English (*U. campestris*). 8 to 10 ft., \$3.00.

HORSECHESTNUT (Aesculus)—

Common. 6 to 8 ft., \$2.75; 8 to 10 ft., \$3.25.

JUGLANS nigra (Black Walnut). 8 to 10 ft., \$3.25.**LARIX** (Japanese Larch)—

leptolepis. 3 to 4 ft., \$2.50.

LINDEN (Tilia)—

American (Basswood). 8 to 10 ft., \$3.00.

European. 8 to 10 ft., \$3.50.

LOCUST (Robinia)—

Pseudoacacia (Common Locust). 4 to 5 ft., \$1.75; 5 to 6 ft., \$2.00.

MALUS—

angustifolia (Bechtel's Double-flowering Crab). Large, double pink flowers highly fragrant and resembling pink Roses. May. Each \$2.00.

floribunda (Flowering Crab). Single flowers, carmine in bud, white when open. Small red fruit in Autumn. \$2.50.

parkmani (Tea Rose-flowering Crab). Long, rich, carmine buds. May. \$2.00.

MAPLE (Acer)—

Norway (*A. platanoides*). 8 to 10 ft., \$4.00; 10 to 12 ft. \$5.00.

Red, or Scarlet (*A. rubrum*). 8 to 10 ft., \$3.50.

Silver (*A. dasycarpum*). 8 to 10 ft., \$2.00.

Sugar, or Rock (*A. saccharinum*). 8 to 10 ft., \$3.50.

10 to 12 ft., \$5.00; 12 to 14 ft., \$6.00.

Weir's Cut-leaf. 8 to 10 ft., \$3.25; 10 to 12 ft., \$3.75.

Japanese, A. palmatum. 3 to 4 ft., \$3.75; 4 to 5 ft. \$5.00

OAK (Quercus)—

Pin (*Q. palustris*). 6 to 8 ft., \$4.00.

Red (*Q. rubra*). 6 to 8 ft., \$3.75.

POPLAR (Populus)—

Carolina, or Cottonwood. 8 to 10 ft., \$1.75; 10 to 12 ft., \$2.00.

Lombardy. 8 to 10 ft., \$1.75; 10 to 12 ft., \$2.00.

SYRINGA japonica (Tree Lilac). 6 to 8 ft., \$2.75.**WILLOW (Salix)**—

Golden Bark (*S. vitellina aurea*). 5 to 6 ft., \$1.25.

Laurel-leaved (*S. laurifolia*). 4 to 5 ft., 75c.; 5 to 6 ft., \$1.00; 6 to 8 ft., \$1.25.

EVERGREEN TREES

ABIES—

concolor (Colorado Blue Fir). One of the most valuable evergreens for the lawn, having long silvery foliage. Symmetrical pyramidal form; a very graceful tree. 3 to 4 ft., \$10.00; 4 to 5 ft., \$12.00.

JUNIPERUS communis (Spreading Juniper). Valuable for covering banks. 18 to 24 in. spread, \$2.50.

horizontalis (Creeping Juniper). Spreads out very close to the ground. 18 to 24 inches. \$4.50.

hibernica (Irish Juniper). 2½ to 3 ft., \$4.50.

virginiana (Red Cedar). 3 to 4 ft., \$5.50.

PICEA alba (White Spruce). Valuable for planting near the sea. \$3.50.

engelmanni (Engelmann's Spruce). A choice Rocky Mountain tree of pyramidal growth and glaucous foliage. 3 ft., \$10.00.

excelsa (Norway Spruce). The most common Spruce used. Valuable for screens and groups. 3 ft., \$3.50; 4 to 5 ft., \$6.00.

pungens (Colorado Spruce). The hardiest of all Spruces. Fine for lawns. 3 ft., \$8.00; 4 to 5 ft., \$11.00.

pungens, var. kosteriana (Koster's Blue Spruce). The finest of all evergreens for lawn decorations. 3½ ft., \$30.00; 4 ft., \$35.00. Price on large specimens on application.

PINUS austriaca (Austrian Pine). One of the best pines for seashore planting. 3 to 4 ft., \$7.00.

Mugho (Dwarf Pine). This is valuable for shore planting and lawns. 18 in., \$5.00; 18 to 24 in., \$5.75.

PINUS—Continued

resinosa (Red Pine). A native; useful for foliage effect; tall-growing. 4 to 5 ft., \$6.00; 5 to 6 ft., \$7.50.

strobis (White or Weymouth Pine). Our most valuable timber tree; useful for windbreaks. 2 to 3 ft., \$3.50; 3 to 4 ft., \$4.00.

RETINOSPORA—

filifera. Foliage tread-like and drooping. One of the hardiest. 2 to 3 ft., \$5.50.

plumosa (Plume-like Japan Cypress). One of the hardiest; can be trained in pyramidal form. 2 to 2½ ft., \$4.75; 2½ to 3 ft., \$5.25.

plumosa aurea. Golden form of the preceding. 18 to 24 in., \$3.75; 24 to 30 in., \$4.50.

THUYA occidentalis (American Arborvitae). Useful for hedges. 3 to 4 ft., \$4.50; 4 to 5 ft., \$6.00.

var. Geo. Peabody. Golden foliage, holding its color all Summer. 2 to 3 ft., \$6.00.

var. Hoveyi (Dwarf Arborvitae). Useful for a border 18 to 24 in., \$3.50; 2½ ft., \$4.50.

pyramidalis (Pyramidal Arborvitae). Useful as a specimen. 3 ft., \$6.00; 3½ ft., \$7.00.

TSUGA canadensis (Hemlock). One of the handsomest native evergreens, useful for hedges. 24 to 30 in., \$4.25; 30 to 36 in., \$5.50; 3 to 3½ ft., \$6.75.

Fruit Trees

APPLES

Nothing is so injurious to newly planted fruit trees, especially to those which have made a very vigorous growth the year before, and have long shoots of new wood, as to leave them full length. The very best trees suffer most by leaving all the top on. Don't be afraid to cut.

5 to 7 ft., \$1.25 each, \$13.80 per doz.

SUMMER VARIETIES

Early Harvest. Yellow, medium size. Aug.
Red Astrachan. Red, large. Aug.
Sweet Bough. Pale yellow, large. Aug.
Williams Favorite. Red, excellent. Aug.
Yellow Transparent. Pale yellow, good. Aug.

AUTUMN APPLES

Duchess. Yellow, streaked red.
Fameuse or Snow. Crimson. Nov. to Jan.
Fall Pippin. Greenish yellow, large. Nov.
Gravenstein. Red-striped, large. Oct.
Wealthy. Deep red, white flesh.

WINTER VARIETIES

Baldwin. Red, large.
Bellflower. Large yellow.
Delicious. Large, red.
Hubbardston Nonsuch. Yellow and red, large.
King of Tompkins County. Crimson, large.
McIntosh Red. One of the best, red; Nov., Feb.
Northern Spy. Yellow and red; large.
Rhode Island Greening. Greenish yellow; large.
Roxbury Russet. Medium to large. Dec. to June.
Spitzenburg. Red, medium, excellent. Dec. to April.
Stark. Greenish-yellow, mottled red.
Talman Sweet. Yellow, medium size. Nov. to April.
Winesap. Bright deep red.

DWARF APPLES

\$1.50 each, \$16.50 per doz.

Duchess. Large, striped.
Gravenstein. Large, red striped.
McIntosh. Red.
Red Astrachan. Large.
R. I. Greening. Large, green.
Yellow Transparent. Pale color.

CRAB APPLES

\$1.50 each, \$15.00 per doz.

Hyslop. Dark crimson; large.
Martha. Very prolific, glossy yellow, shaded red.
Transcendent. Yellow and red; large.

CHERRIES

\$1.50 each, \$15.00 per doz.

Black Tartarian. Purplish black; large. June.
Early Richmond. A preserving variety.
Gov. Wood. Yellow and red; large. June.
Montmorency. A large preserving variety.
Napoleon. Yellow and red; large. July.
Windsor. A large deep colored variety of good flavor.
Yellow Spanish. Pale yellow, red cheek. June.

PEARS

Pear trees must have rich soil. Never, however, put manure of any kind where it will touch the roots when a tree is first planted. Put it in the soil, near them, liberally.

5 to 7 ft. \$1.50 each, \$15.00 per doz.

SUMMER VARIETIES

Bartlett. Yellow and large.
Clapp's Favorite. Yellowish green, large.

AUTUMN VARIETIES

Anjou. Greenish yellow. Nov. to Dec.
Beurre Bosc. Russet color; large. \$2.00 each.
Flemish Beauty. Yellowish russet, large and sweet.
Louise Bonne. Yellowish green; small.
Seckel. Yellowish russet; small.
Sheidon. Yellowish russet; medium size.

WINTER VARIETIES

Duchess. Very large yellow with a dull red cheek.
Lawrence. Yellow and red; medium.

DWARF PEARS

\$1.50 each, \$15.00 per doz.

Clapp's Favorite. Yellowish green; large.
Duchess. Very large; yellow with a dull red cheek.
Louise Bonne de Jersey. Large; yellow and red; extra fine.

PEACHES

Keep the leading branches well pruned back, and in the Spring prune back all shoots of the previous year's growth, thus insuring sound and well-furnished heads with bearing wood, weak shoots being reduced one-half and stronger ones from one-third up, being careful to retain an adequate supply of fruit buds. Keep the ground clean and well worked about the trees, and give an occasional dressing of wood ashes.

75c. each, \$8.00 per doz.

Belle of Georgia. White, red cheek; large, very late.
Carman. Pale yellow with red blush. Large and sweet flavor.
Champion. Creamy white, red cheeks; large. Aug. 1.
Crawford's Early. Yellow and red; large. Aug.
Crawford's Late. Yellow and red; large. Sept.
Elberta. Large; light yellow. Aug.
Foster. Large, yellow, of very good quality; season early Sept.
J. H. Hale. Large, yellow freestone. Sept.
Mountain Rose. Large, red, with white flesh; early.
Oldmixon Free. White and red; large. Sept.
Stump the World. White and red; large. Sept.

QUINCES

\$1.50 each, \$15.00 per doz.

Apple, or Orange. Large, roundish; bright golden yellow; very productive. Early to late.
Champion. Large; yellow; very productive, and ripening very late.
Rea's Mammoth. Large, yellow; one of the best. Early.

FRUIT TREES—Continued

PLUMS

The growth of the Plum tree is being better understood by cultivators, thorough culture and careful attention to the destruction of the black knot and curculio being the most essential points to consider.

5 to 7 ft., \$1.50 each, \$15.00 per doz.

Bavay's Green Gage. Greenish yellow; large. Sept.
Bradshaw. Very large, oval, dark violet-red, sweet, good flavor.

Lombard. Violet-red; medium. Sept.
Shropshire Damson. Purple; medium. Oct.

JAPAN PLUMS

These have quickly found favor among growers on account of their great vigor, freedom from disease, and the fact that they come into bearing two or three years after planting. They are of high quality, beautiful in appearance, and keep for an unusually long period after picking.

\$1.50 each.

Abundance. The fruit is large; amber in color, turning to a rich, bright cherry, and highly perfumed; flesh tender and of delicious sweetness. It ripens in August.

Burbank. Clear cherry-red, with yellow dots; flesh deep yellow, rich and sugary. The tree is low and spreading and an abundant bearer. End of Aug.

October Purple. Large, dark reddish purple, superb quality. Middle of Sept.

Satsuma. Purple and red, flesh firm; juicy and dark red large. Aug.

Wickson. Fruit large, dark, showy and of the highest quality. Free, most vigorous and prolific.

Small Fruits

CURRENTS

On account of Pine Blister Rust, which is said to spread from these plants, we have discontinued selling Currants and Gooseberries.

GOOSEBERRIES

BLACKBERRIES

To keep a Blackberry bed in good productive condition the old, weak and deadwood should be cut out every season to give strength to the young shoots for the next year's bearing. In Spring the weakest suckers should be removed, leaving five or six of the strongest in each hill; the ground should be spaded and a top dressing of manure given. Rows 5 feet apart and plants 4 feet apart in the rows.

\$1.25 per doz., \$9.00 per 100.

- Agawam.** Sweet, medium size. Early.
- Eldorado.** Extra fine and very hardy large, sweet berry.
- Erie.** One of the best; large and productive. Early.
- Rathbun.** Very large, sweet and delicious.
- Snyder.** Medium size; very fine. Medium.

RASPBERRIES

Treat and cultivate as recommended for Blackberries.

\$1.50 per doz., \$10.00 per 100, unless priced otherwise

- Columbian.** Purple fruit, delicious for table.
- Cuthbert.** Medium to large red sweet.
- Golden Queen.** Large, yellow; fine quality. \$2.00 per doz.
- La France.** New, everbearing variety. \$2.50 per doz., \$18.00 per 100.

- Marlboro.** Popular red sort. Early and hardy.
- St. Regis Everbearing.** Producing abundantly throughout the Summer, large, bright crimson berries of excellent quality.

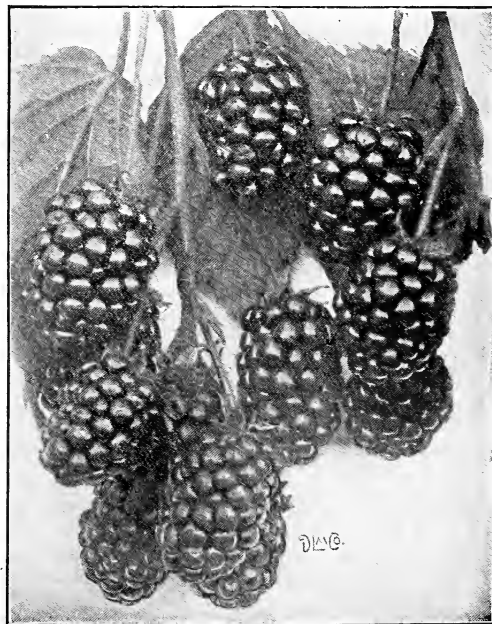

Blackberries

SMALL FRUITS—Continued

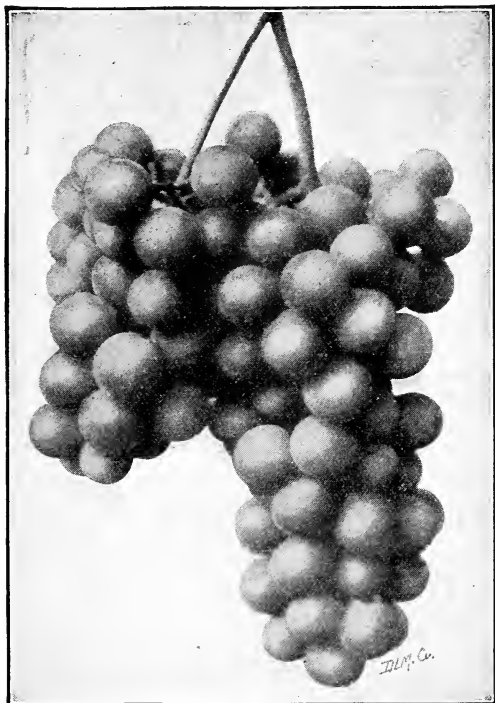

Grapes

GRAPES

[HARDY VARIETIES

60c. each, except where noted.

BLACK

Campbell's Early. Very large berry and clusters, rich flavor and very sweet. 75c.

Concord. Large, always reliable. Medium.

Moore's Early. Large, fine quality. Early.

Worden. Large, excellent quality. Early.

RED

Brighton. Large, best quality. Early.

Catawba. Well-known late variety.

Delaware. Small, delicious. Late. 75c.

Salem. One of the best and most popular; ripens with the Concord variety.

WHITE

Green Mountain. One of the best. Early. 75c.

Moore's Diamond. Large, excellent. Early.

Niagara. Large and productive. Medium.

GRAPE

MUSCAT OF ALEXANDRIA

For greenhouse planting. Extra strong with healthy roots. Will make first-class planting canes. Well established in about 8-inch pots

\$12.00 each

STRAWBERRIES

The Strawberry will grow in any good garden soil where the ground has been thoroughly prepared. For family use we recommend planting them in double rows, 1 foot apart each way and 5 feet between the double rows, allowing a sufficient number of runners to grow into the wide passage to cover about 1½ feet on each side; all the rest should be pinched off. It is advisable to cover the plants in Winter with litter, which should be removed as soon as the plants commence to grow in Spring.

Layer plants in Spring, \$3.00 per 100, \$28.00 per 1000, except where noted.

Pot-grown plants after Aug. 1

Abington. Strong grower and great yielder. The bright red berries are of very large size, firm and fine flavor. Early to medium.

Arabine. Extra early, very large, bright red of high quality, very robust grower and heavy cropper.

Barrymore. Awarded silver medal and three first premiums by the Massachusetts Horticultural Society, in 1908. A great berry for all purposes. Large size, rich, dark, glossy crimson color; conical shape; flesh red and quality excellent. Medium.

Big Joe. A magnificent new Strawberry of robust growth and very prolific. The berries are light crimson in color and very large. Medium.

Brandywine. Large, roundish, conical, bright, glossy crimson berries, firm and solid; excellent quality and fine flavor. Medium.

Commonwealth. Large, glossy crimson berry, of excellent quality, a great cropper and one of the latest.

Gibson. Very large, deep red, fine flavor. Medium.

Glen Mary. Very large, highly colored, firm, and ranks with the best in flavor. Medium to late.

Golden Gate. New seedling, resembles the Marshall and will succeed where the Marshall fails. It produces strictly fancy, firm fruit clear to the end of the season, of a rich crimson color.

Judith. A large, medium-red, pointed berry; a good market variety; very early.

Marshall. Large, rich crimson, and fine flavor. One of the most popular sorts. Medium. \$3.25 per 100, \$28.00 per 1000.

Premier. One of the best of the extra early varieties; does well in almost any section; excellent quality; bright red.

Senator Dunlap. Dark red berries of medium size. The flesh is red all through, and exceedingly juicy. Early midseason.

Warren. Dark blood red, extra size, broad and flattened at tips, borne in large clusters. Medium.

EVERBEARING STRAWBERRIES

Mastodon. Truly a Wonderberry, in size, flavor and yield. \$9.00 per 100.

Progressive. The fruit is rich and sweet, a deep red inside and out; of good medium size and quite firm. \$4.00 per 100.

Superb. Perfect blossoms. Enormous crops in June, and in September. It does not fruit on new runners. \$4.00 per 100.

All prices subject to change without notice

Farm, Garden and Lawn Requisites, Tools, Etc.

Asparagus Buncher. Makes bunches of size usually sold in Boston market. \$6.00 each.

Asparagus Knife. Also used as a weeder. 50c. each.
Axes. Warranted steel, Witherell's extra quality, handled. \$3.00 to \$3.50 each.

Bands, Rubber. For bunching Asparagus, Celery, Beets, Radishes, etc. Used in place of twine or tape. In 1-lb. boxes, \$1.25 per lb.

Bars, Crow. Solid cast steel. Per lb. 12c.

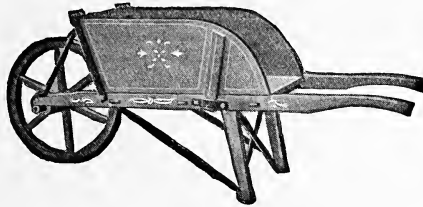

Barrow, New England Garden. This is a strong, well-made barrow; the frame is made from best seasoned timber, nicely painted and striped, it has an eight-spoke, steel axle, wood wheel. We consider it the best garden barrow manufactured. Three sizes, No. 64 medium, \$8.50; No. 65, large, \$9.50; No. 66, extra large, \$11.00.

Barrow, Garden, No. 4. Boys' or ladies'. \$6.50.

Barrow, Greenhouse. Made especially for greenhouse. Long narrow bodies with steel wheel. \$12.00.

Barrow Leaf Rack. Made of galvanized wire, with wood bottom, capacity ten bushels. \$10.00.

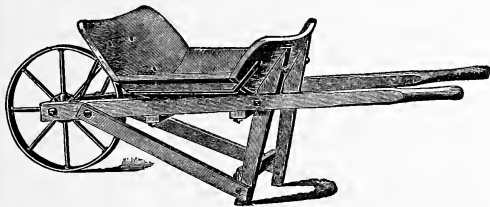

Barrow, Canal. We carry this in stock in either wood or steel tray; popular with contractors. Wood tray, \$6.00 each; steel tray, \$6.50 each.

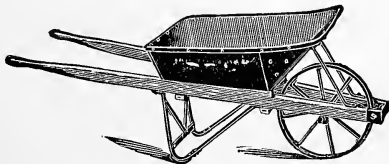

Barrow, Steel Tray End Dump. For conveying concrete, mortar, sand, gravel, cement, fertilizer, manure, etc. This is an end dumping barrow; has protected wheel and renewable shoes on legs; is provided with crossbar between legs for plank riding; carries load level and well over wheel; has an extra strong strapped tray, smooth on inside, and many other good points. \$10.00 each.

Baskets, Tomato or Pansy. Wire handles, also used for fruit as well as plants. 100 1000
3-quart size.....\$4.50 \$40.00
2-quart size.....3.50 32.00

Baskets, Picking. For gathering fruit or vegetables. Swing or Stationary Ball. 1 pk. \$1.00, ½ bus. \$1.25, 3 pks. \$1.50.

Baskets, Shepherd. 1 bus. \$2.50 each; 2 bus. \$4.00 each.

Baskets. For holding leaves. 4 bus. \$6.00 each.

Baskets, Vegetable. Strapped bail. ¼ bus. \$1.00 each; ½ bus. \$1.25 each, ¾ bus. \$1.50 each, 1 bus. \$1.75 each.

Basswood Poles. 14 ft. long. Used for pruning and tree painting. 75c. each, \$8.00 per doz.

Bamboo Poles. 20 ft. 75c. each, \$8.00 per doz.

Baskets, Wire Hanging. Either round or flat bottom. 6 in. 40c. each; 7 in. 50c. each; 8 in. 60c. each; 10 in. 70c. each; 12 in. 80c. each.

Bellows, Houchin Dry Powder. \$3.00 to \$4.00 each.

Bill Hooks. For heavy pruning. English, \$3.50; American, \$2.50.

Boxes for Cut Flowers. The following sizes are kept in stock. Others can be furnished promptly.

No.	Length	Width	Depth	Doz.	100
1	18 in.	5 in.	3 in.	\$1.00	\$7.00
2	21 in.	5 in.	3½ in.	1.10	7.50
3	24 in.	5 in.	3½ in.	1.20	8.00
4	28 in.	5 in.	3½ in.	1.30	9.00
5	21 in.	8 in.	5 in.	1.40	9.50
6	24 in.	8 in.	5 in.	1.50	10.50
7	28 in.	8 in.	5 in.	1.75	13.00
8	36 in.	8 in.	5 in.	2.25	16.50

Corrugated Shipping.

Size	Inches	Each	Doz.
B	24x12x6	\$0.50	\$6.00
C	30x12x7	.60	7.00
D	36x12x9	.65	7.50
E	40x15x9	.90	10.00
F	48x15x9	1.00	11.50

Brooms. For use in greenhouses, stables, etc. Two sizes, \$1.00 and \$1.25 each.

Brooms. Rattan and broom corn mixed. \$1.50 each.

Brooms. Rattan, push or street, 16 in. \$1.25 each.

Brooms and Rakes, Bamboo. Japanese. Very useful on lawns, driveways and golf courses. Prices: Brooms \$1.00 each; Rakes, 18 in. \$1.00 each; 24-in. \$1.25 each.

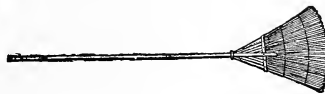

Brushes, Dandy. Imperial. \$1.00 each.

Brushes. For applying creosote to destroy eggs of the gypsy moth. 50c. each, \$5.00 per doz.

Brushes, Pole. Complete with bracket to attach to pole for using creosote in high places. \$1.25 each.

Brushes and Can. For creosote. The can fastens to the belt, leaving the hands free. \$1.00 each.

Bull Rings. Copper. Manufactured from the best material only; will not injure the bull's nose. 50c. each.

Bull Rings. Cannon metal. Extra heavy. \$1.75 each.

Burlap. For putting around trees to trap gypsy moths. 8 in. wide, 8c. per yard; 100 yards \$7.50. 40 in. wide, 22c. per yard; piece about 100 yards, 20c. per yard.

Burning Brands. For marking tools, etc. Six letters or less, \$6.00; each additional letter, \$1.00.

Bush Hooks. Strapped-eye handle. \$2.00.

Carnation Support, Excelsior. Heavy galvanized wire. In two sizes, 13 in. \$3.00 per 100; 20 in. \$3.50 per 100. One of each length makes a complete plant support.

Chains. Best quality steel. Ajax breast, 32 in. \$2.50 per pair; Cow Ties, 75c. each. Tie out chains, 20 feet, \$1.00 each; 30 feet, \$1.50 each. Long, Heavy Trace, \$3.00 per pair; Heavy Whiffletree, \$1.50 per pair.

Coal Tar. For covering scars made by removing large limbs from trees. \$1.00 per gal., \$4.00 per 5 gals.

Cotton Wadding. In large sheets, for protecting plants and flowers from frost. 10c. each, \$1.10 per doz., \$8.00 per 100.

FARM, GARDEN AND LAWN REQUISITES, TOOLS, ETC.—Continued

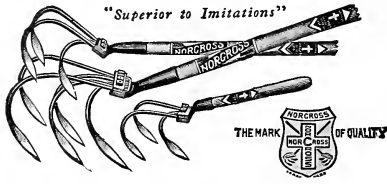

Cultivator, The Norcross Hand Garden. Does the work easier and faster than any wheel hoe. Each
 5 prong, 4-ft. handle..... \$1.00
 3 prong, 4-ft. handle..... .75
 3 prong, 9-in. handle..... .50

Cultivator, Norcross, A. B. C. Wheel. \$6.50. For description, see page 100.

Curry Cards. Small size. 25c. each; large, 35c. each.

Curry Combs, English. 50c. each.

Dibbles. Steel points, wooden handle. 75c. each.

Ferrules and Caps and Mal. D's for Handles, 15c. 5c. and 25c. each.

Edging Knife. American, \$1.35.

Edging Knife, English. \$2.50 each. Handles, extra, 50c. each.

Electric Tape. For mending hose, etc. 50c. per coil.

Flower Pot Saucers, Lacquer Waterproof. These are selected clay saucers which have been processed with a practically colorless lacquer that renders them nonporous. They are rapidly gaining in favor.

Size.....	Each	Doz.	100
4.....	\$0.07	\$0.75	\$4.50
5.....	.10	1.00	7.00
6.....	.15	1.50	10.00
7.....	.20	2.00	13.50
8.....	.25	2.50	18.50
9.....	.30	3.25	25.00
10.....	.40	4.25	34.00
11.....	.45	5.25	40.00
12.....	.65	7.00	60.00
13.....	.75	8.50	65.00
14.....	1.00	10.00	80.00
16.....	1.50	16.00	125.00

Hew's Flower Pots, Standard

Measurement from inside to inside. Width and depth equal.

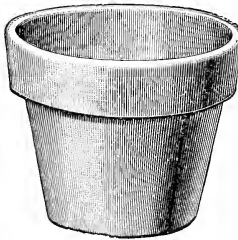

Inches	Doz.	100
2.....	\$0.20	\$1.40
2½.....	.30	1.85
3.....	.35	2.50
3½.....	.45	3.00
4.....	.60	3.75
4½.....	.75	5.00
5.....	.90	6.75
6.....	1.40	10.00
7.....	2.25	17.00
8.....	3.25	24.50
9.....	4.75	38.00
10.....	7.00	50.00
11.....	10.00	75.00
12.....	14.00	100.00

Flower Pot Hanger, Krich's Perfect. No. 1 will fit from 3½- to 5-in. pots, 40c. per doz. No. 2 will fit from 5- to 8-in. pots, 45c. per doz.; No. 3 will fit from 8- to 12-in. pots, 50c. per doz.

Bulbs and Seed Pans, Round

Size	Each	Doz.	Size	Each	Doz.
6 inches.....	\$0.15	\$1.50	10 inches.....	\$0.75	\$7.00
7 inches.....	.20	2.25	12 inches.....	1.25	14.00
8 inches.....	.30	3.25	14 inches.....	1.75	20.00
9 inches.....	.50	5.50	16 inches.....	2.75	25.00

Fern Pans. These pans are made thin and strong, especially adapted for linings to porcelain and silver fern pans. Dimensions given are outside measurements.

Size.....	Each	Doz.
4¾ x 2½.....	\$0.09	\$0.95
5½ x 2¾.....	.12	1.20
6¼ x 2½.....	.14	1.35
7 x 2¾.....	.15	1.60
8 x 3½.....	.20	2.30
9 x 3½.....	.25	2.80
10 x 4.....	.30	3.15

Flower Pots, Bird's "Improved" Neponset. Made from a properly prepared fabric, which gives the necessary firmness, unbreakable, and made so as to give ample drainage. Not less than one crate at 1000 price.

Inches	In crate	Doz.	100	1000
2¼.....	1000.....	\$0.15	\$0.50	\$3.75
2½.....	1000.....	.18	.60	4.25
3.....	1000.....	.20	.75	6.00
3½.....	1000.....	.25	1.00	7.50
4.....	500.....	.30	1.25	9.50
5.....	500.....	.40	1.75	15.00
6.....	500.....	.50	2.50	20.00

Flower Pot Saucers, Standard.

Inches	Doz.	100	Inches	Doz.	100
3½.....	\$0.35	\$2.50	9.....	\$1.90	\$14.00
4.....	.50	3.25	10.....	2.35	17.00
5.....	.60	3.75	11.....	2.75	21.00
6.....	.85	5.75	12.....	3.75	26.00
7.....	1.10	8.00	13.....	4.25	35.00
8.....	1.50	11.00	14.....	5.00	40.00

Flower Vases, Galvanized Iron. Strong, light, durable, made of good material with heavy hoop at base of can to reinforce bottom of vase. These vases are finished in a moss green enamel baked on.

No.	Top Diam.	Bot. Diam.	Hght.	Each	Doz.
5	7¾ in.	5½ in.	11 in.....	\$1.25	\$13.50
6	7¾ in.	5½ in.	17 in.....	1.50	16.00
7	8 in.	6¼ in.	11 in.....	1.25	13.50
8	9 in.	7¾ in.	12 in.....	1.50	16.00
9	9 in.	7¾ in.	17 in.....	1.75	18.00
10	6½ in.	5 in.	14 in.....	1.25	13.50
11	5½ in.	4¼ in.	15 in.....	1.25	13.50
12	5 in.	4 in.	9½ in.....	1.00	11.00

Floral Tools "American." These tools are not toys, but serviceable tools, of high grade material, well made and finished.

Per Set	
No. 4, P. S. F. Four piece set: Shovel, Rake, Hoe, and Spading Fork.....	\$3.25
No. 3 P. F. Three piece set: Shovel, Rake and Hoe.....	2.25
Extra Rakes for above set.....	Each .55
Extra Spading Forks.....	Each 1.10
Extra Hose.....	Each .85
Extra Floral Shovels.....	Each .90

Forks, Ensilage. 8 tine, D. handle, strapped..... 3.00

Forks, Hand. For transplanting, American..... .50

Forks, Hand. For transplanting, English..... 1.25

Forks, Hay. 4 to 6 ft., bent handles..... \$1.25 to 2.00

Forks, Manure. 4 tine, mal. D. handle, strapped 2.00

Forks, Manure. 5 tine, mal. D. handle, strapped 2.25

Forks, Manure. 6 tine, mal. D. handle, strapped 2.50

Forks, Manure. 4 tine, wood D. handle, strapped 2.50

Forks, Manure. 5 tine, wood D. handle, strapped 2.75

FARM, GARDEN AND LAWN REQUISITES, TOOLS, ETC.—Continued

- Forks, Manure.** 6 tine, wood D. handle, strapped Each \$3.00
- Forks, Manure.** 4 tine, long handled, strapped 2.00
- Forks, Manure.** 5 tine, long handled, strapped 2.25
- Forks, Manure.** 6 tine, long handled, strapped 2.50
- Forks, Spading.** 4 tine, long handled, strapped 2.00
- Forks, Spading.** 4 tine, mal. D. handle, strapped 2.00
- Forks, Spading.** 4 tine, wood D. handle, strapped 2.50
- Forks, Spading.** 5 tine, mal. D. handle, strapped 2.50
- Forks, Stone.** ... 8 tine, mal. D. handle, strapped 2.50
- Garden Lines, Braided.** 100 ft. \$1.25, 200 ft. \$2.25.
- Garden Line Reels.** Small \$1.50, large \$2.00 each.
- Glass Cutter.** 25c. and 50c. each.
- Glaziers' Points (Perfection).** Will stop glass from slipping. Made of steel wire galvanized. Double point. Per box of 1000, No. 2, 85c.; No. 2½, 90c.
- Glaziers' Points (Zinc City).** Made of zinc. Will not rust. In three sizes, ⅝, ¾ and ⅞ inches long. Each size 75c. per lb.
- Gloves, Gardeners' Pruning.** With gauntlets, \$3.00 per pair; without gauntlets, \$2.00 per pair.
- Grafting Knife, or Chisel.** All steel, \$1.50.
- Grafting Wax.** ¼ lb. 20c., ½ lb. 30c., 1 lb. 50c.
- Grass Hooks, or Sickles.** English, No. 2, \$1.00 each No. 4, \$1.25 each; American, 75c., and \$1.00 each.

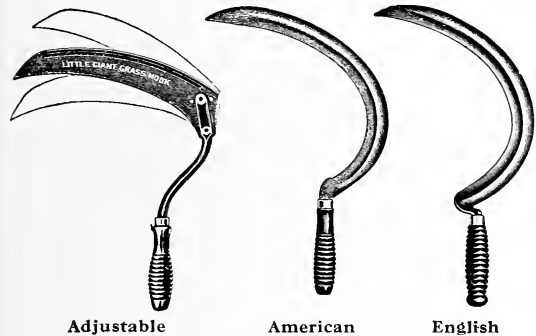

Adjustable American English

GRINDSTONES

Our stones are selected by a person thoroughly posted on the merits of the different quarries, regarding fineness and sharpness of grit, and all points of advantage to the various uses to which a stone is put. The frame is of selected oak, solidly bolted together, and will last for years. The fixtures are selected with a view to the requirements of the stone on which they are to be used.

Each	Each
20 in. diam., complete \$20.00	26 in. diam., complete \$26.00
22 in. diam., complete 22.00	28 in. diam., complete 28.00
24 in. diam., complete 24.00	30 in. diam., complete 30.00

- Grindstone Fixtures.** \$2.50 to \$4.00 per set.
- Grindstones, Unmounted.** 15c. per lb.
- Hammer, Nail.** Adze eye, bell face, extra quality. \$1.25 to \$1.75 each.
- Hammer, Stone.** Solid cast steel, forge finished and oiled. 3 to 5 lbs., 30c. per lb.; 5 to 30 lbs., 25c., per lb.
- Hammer, Stone Striking.** Solid cast steel, forge finished and oiled. Under 5 lbs., 30c. per lb.; 5 to 30 lbs., 20c. per lb.
- Hatchet, Shingling.** Cast steel, polished bits. \$1.25 each.
- Hatchet, Barrel.** \$1.25 to \$1.75.

- Hatchet, Axe Pattern** \$1.25 and \$1.50 Each
- Handles, Axe.** Extra quality hickory..... .75
- Handles, Hammer.** Extra quality hickory..... .50
- Handles, Pick.** Extra quality hickory..... .75
- Handles, Hay Fork.** Extra quality ash..... 50c. to 1.00
- Handles, Hoe.** Extra quality ash..... .35
- Handles, Manure Fork**..... 75c. to 1.25
- Handles, Shovel and Spade**..... .75
- Handles, Rake**..... .60
- Hoes, Nurserymen's. Two-pronged Steel**..... 2.50
- Hoes, Boothby-toothed**..... 1.60
- Hoes, Humphrey**..... 1.00
- Hoes, American Scuffle, Handled.** 8 in. \$1.25 each.
- Hoes, English, or Dutch Scuffle.** 3 in. 75c., 4 in. 80c., 5-in. 85c., 6 in. 90c., 7 in. \$1.00, 8 in. \$1.10, 9 in. \$1.25 each. Handled, extra, 75c.
- Hoes, Market Gardeners' Slide or Scuffle. (Arlington)** Handled, 4 in. to 9 in. \$3.50 each.
- Hoes, Garden, Socket Draw.** 8 in. \$1.25 each.
- Hoes, Meadow.** 9 in. \$1.35, 10 in. \$1.50 each.
- Hoes, Warren.** \$1.50 each.
- Hoes, Mortar or Street.** 10 in. \$1.50 each.
- Hoes, Ladies' and Boys'.** 90c. and \$1.00 each.
- Hoes, Onion.** \$1.25 each.
- Hoes, Weeding.** 6 tooth. \$1.25 each.
- Hose Connection, Shut-off.** For use with any nozzle that has no shut-off where one is desired. \$1.00 each.
- Hose Connection, Siamese.** \$1.50 each.
- Hose Coupler, "Rain King."** Instantly connects hose to faucet, hose to sprinkler, hose to nozzle, or hose to hose. Don't bother screwing hose connections together. Just snap them on instantly with this new invention. 60c. each.
- Hose Couplings.** ½, ⅝ and ¾ in., per set, 35c. each.
- Hose Menders, Hudson's.** Boxes containing 1 pair pliers, 5 metallic tubes and 15 wires, per box 75c. Metallic tubes, per doz., ½ in. or ¾ in. 50c. Wires, 15c. per doz., \$1.00 per 100.
- Hose Mender, Cooper's.** Made of heavy brass, requires no wires or pliers to adjust it. 10c. each, \$1.00 per doz.
- Hose Menders, Perfect Clinching.** In one piece, doing the work of the mender tube and two clamps ordinarily used. ½, ⅝ and ¾ in., 15c., each, \$1.25 per doz.
- Hose Clamps.** Made of galvanized steel with screw adjustment. ½ and ¾ in., 5c. each, 50c. per doz.
- Hose Reducers.** For connecting ½ in. and ¾ in. hose couplings with bordeaux or Vermorel Nozzles. 50c. each.
- Hose Nozzle, Bordeaux Spray.** \$1.25 each; with reducer for ¾ in. hose \$1.75.
- Hose Nozzle, New Boston.** Will throw a coarse or fine spray or a large or small stream. Price 75c. each.
- Hose Nozzle, Rain King.** Claimed by manufacturer the first perfect hose nozzle ever made. With only one-quarter turn it will throw from a long, solid spray to the finest mist spray. Throws more water farther than any hose nozzle made. Price \$1.50 each.
- Hose Nozzle, Stott's.** Specially recommended for greenhouse spraying. Throws a forcible side spray. Price \$2.00 each.
- Hose Nozzle, Rose Spray.** For greenhouse, flower garden, hotbed, etc. Heavy brass, 3-in. face, \$1.00 each; 4-in. face, \$1.25. Copper, \$1.50 each.

FARM, GARDEN AND LAWN REQUISITES, TOOLS, ETC.—Continued

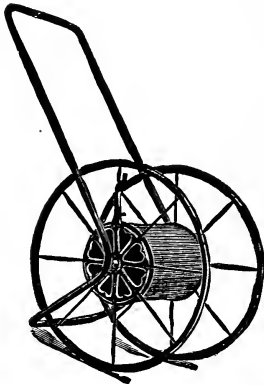

Hose Reels. All metal, strong, substantial hose reels for gardens or lawns. Made with high wheels, almost indestructible. No. 10, holding 100 ft. \$6.00. No. 20, holding 150 ft., \$7.00.

Hose, Rubber Garden. "Dreadnaught Brand." A braided hose made of the best materials. Does not kink. We offer this in 25 and 50 ft. lengths coupled; also in continuous lengths of 500 ft. ½ in. at 22c. per ft., ¾ in. at 25c. per ft.

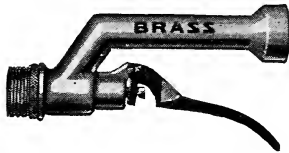

Hose Nozzle Holder. Any hose nozzle can be attached. Automatic and entirely of Brass. By a pressure of the fingers on the handle, the spray is turned on, by releasing the pressure the spray automatically shuts off; unlike most

shut offs, it only takes one hand to manipulate it. Price \$1.75 each.

Hose, Washers, Rubber. For ½ in. and ¾ in. hose. Per doz. 5c., per ¼ lb. 50., per lb. \$1.50.

Knives, Budding and Pruning. Imported. In various styles, \$1.50 to \$5.00 each.

Labels, Copper. Made of copper and copper wired. Indestructible and always legible. No. 1, 3½ x ¾ in. \$2.25 per 100; No. 2, 5 x 1½ in. \$2.75 per 100.

Labels, Simplex Weatherproof. Made of celluloid with mica cover. The writing is protected by the transparent cover, and will last indefinitely if done with a lead pencil. Whatever water enters the sides will not deface the marking, as the graphite of the pencil is not soluble and requires friction to remove it. This friction is prevented by the transparent cover. (Price includes copper wires for attaching.)

	Doz.	100
No. 1. 3 x ½ in.	\$0.50	\$3.00
No. 2. 4 x ¾ in.75	5.00
No. 3. 5 x 1 in.	1.00	7.00

Labels, Wood. For plants and trees.

	Plain or Painted	Plain	Painted
	100	1000	1000
4 in. Pot Label.....	\$0.25	\$1.50	\$1.90
5 in. Pot Label.....	.30	2.00	2.50
6 in. Pot Label.....	.35	2.25	3.00
8 in. Garden Label.....	.90	6.50	8.00
10 in. Garden Label.....	1.15	8.25	10.50
12 in. Garden Label.....	1.50	10.50	13.00
3½ in. Tree Label.....	.25	1.25	1.75
3½ in. Tree, iron wired....	.30	2.00	2.50
3½ in. Three, copper wired. .35		2.50	3.00

Labels, Wood Border. 16 x 1¾ x ¾ in., \$6.00 per 100, \$55.00 per 1000.

Lawn Boots, Horse. For lawn or golf work they are indispensable. They prevent the horse from sinking in soft places and from cutting or tearing up the turf. Made from select material, durable and easily adjusted.

Links-Lawn. Per set.....\$18.00

Lawn Sprinklers, Cyclone. 1 ft. high, 3 arms, \$1.25.

Lawn Sprinkler, Ring. Made of brass. \$1.00 each.



Lawn Sprinkler, Standard Rain King. A real innovation in the sprinkler line, and radically different from any other sprinkler ever made. Price \$3.50 each.

Lawn Sprinkler, Giant Rain King. The Giant among Sprinklers. Stands four feet high and has 20-inch arms. Fills every sprinkler requirement. For fine lawns, estates, parks, and golf greens. Price \$12.50.

Lawn Sprinkler, Two Purpose Rain King. Combination Hose Nozzle and Stationary Garden Spray. Price \$2.00 each.

Lawn Sprinkler "Putting Green." This sprinkler is made for golf courses but will do equally well on private lawns and parks where heavy distribution in short time is required. 44 in. high with two arms. \$8.00 each.

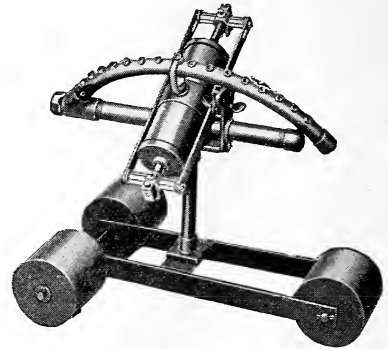

Lawn Sprinkler, Rain Wave. The Rain Wave Sprinkler embodies the Skinner System principles of watering. Covers about 60 ft. by 60 ft. with 35 lbs. pressure. Beautiful in operation. Built for many years service. Very popular with private estates and golf clubs. Circular on request. Price \$45.00.

Manure Hooks. Long handle, 4-tine \$1.50, 5-tine \$1.65, 6-tine \$1.75.

Mats, Hotbed. Made by hand of the best rye straw. Size 6 x 6 \$3.50.

Mats, Hotbed. 76 x 76 in. Covers two sash, made of heavy cotton or duck, filled and quilted, \$5.50 each.

Mattocks. Short cutter on grub hoe. 3 lbs. \$1.00 each.

Mattocks, Long Cutter. Extra quality. \$1.50 each.

Mattocks, Pick. Extra quality. \$1.50 each.

Melon Nets. For supporting Melons in the greenhouse. 35c. each, \$3.50 per doz.

Mole Traps, "Little Giant." \$1.50 each.

Oilers. With spring bottom. 25c. to 75c. each.

Oil, Harvester. For mowers, reapers, etc. Gal. \$1.25.

Pails, Stable. Heavy galvanized iron, 10 qt. 50c., 12 qt. 65c., 14 qt. 75c.

Paper, Green Waxed. Sheets 12 x 18 in., lb. 75c.

Paper, White Tissue. Sheets 20 x 30 in., lb. 50c.; ream about 7 lbs., \$2.75. Sheets 24 x 36 in., lb. 50c. Ream about 9½ lbs. \$4.00.

FARM, GARDEN AND LAWN REQUISITES, TOOLS, ETC.—Continued

Paper, White Waxed. Sheets 14x18 in., lb. 50c. ream, about 5 lbs., \$2.00. Sheets 24x36 in., 50c. per lb. Ream, about 12 lbs. \$5.00.

Paper, White Wrapping. Sheets 24x36 in., lb. 22c. Ream, about 40 lbs. 20c. per lb.

Pencils, Indelible Label. With point protector. Black or blue, 20c. each.

Picks, Contractors. Best refined iron with steel points. \$1.50 each.

Plant Protecting Cloth for Hotbeds. Valuable for covering hotbeds and frames, instead of glass. Medium grade, per yd. 25c., by the piece (about 60 yds.) 24c.

Plant Tubs, Cedar. For ferns, palms and other large plants. Made of thick cedar, nicely painted green. Drop handles. No. 2 and larger have hook handles. Outside measurements:

No.	across top	Diam.	Height	Each
1	28 in.	22 in.	16 in.	\$16.50
2	26 in.	20 in.	13.50	13.50
3	24 in.	18½ in.	11 in.	8.75
4	22 in.	17 in.	9 in.	7.00
5	20 in.	16 in.	8 in.	5.75
6	18½ in.	15 in.	7 in.	4.50
7	17 in.	14 in.	6 in.	4.00
8	16 in.	13 in.	5 in.	3.50
9	14 in.	12 in.	4 in.	2.75
10	12 in.	9½ in.	3 in.	2.25
11	10½ in.	9 in.	2 in.	1.50
12	9½ in.	8 in.	1 in.	1.50
13	8 in.	7 in.	1 in.	1.25



Tubs, Richmond Cedar. Strongly made of selected white cedar and bound with electric welded wire; painted green. Without handles.

No.	Diam. inside	Each	No.	Diam. inside	Each
6	11 in.	\$1.50	10	15 in.	\$2.75
7	12 in.	1.75	11	16 in.	3.00
8	13 in.	2.00	12	17 in.	3.50
9	14 in.	2.50	13	18 in.	4.00

Plant Sprinklers, Scollay's Rubber. Straight neck or angle neck. Large size, \$1.50 each.

Post Hole Digger. 4 ft. Atlas. \$2.00 each.

Potato Hooks. Steel shank, 5-tine \$1.35; 6-tine \$1.50.

Potato Digging Fork. 6-tine \$2.25.

Pruner, Standard Tree. Operated by a lever, to which the blade is connected by iron rod, 6-ft. pole \$1.75, 8-ft. pole \$2.00, 10-ft. pole \$2.25, 12-ft. pole \$2.50, 14-ft. pole \$2.75, 16-ft. pole \$3.00 each. Extra blades, 25c. each.

Pruner, Telephone Tree. Without pole (See cut). A pole of any length to suit requirements can be inserted in the socket. It is operated by a cord tied in the end of the lever. \$1.50 each. Extra blades, 25c. each. Extra springs, 25c. each.



Pump "Auto Spray." Wheelbarrow type. For use in garden, greenhouse or orchard it is especially adapted. Also used for whitewashing. It has a galvanized steel tank, steel truck and wheel, brass plunger head, cylinder and valves. Perfect agitation. No. 3D, 12-gal. complete, price, \$21.50.

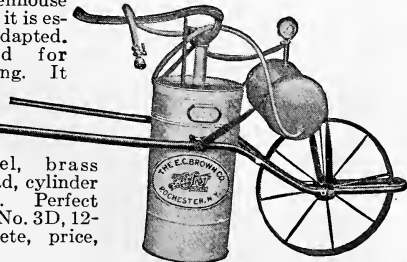

No. 3F, 12-gal. complete with air pressure tank and gauge. Price \$35.00.

Pump Auto Spray.

An efficient compressed air sprayer for all-round use. Each pump is equipped with extra strong corrugated tank, clog-proof automatic shut-off nozzle; 2-ft. brass extension rod. Full instructions, illustrated list of repair parts and authoritative spray calendar.

No. 1B, 4-gal. brass tank, price \$10.00.
No. 1D, 4-gal. galv. tank, price \$7.00.
No. 50B, 2½-gal. brass tank, price \$8.50.
No. 50D, 2½-gal. galv. tank, price \$6.00.
Brass strainer for same, price \$1.25.
Brass elbow r same, price 35c.



It's Double Acting

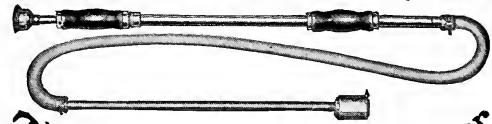

The Same Spray With Half The Labor

Pump, Auto Spray No. 5. Generally acknowledged to be the most powerful pump of this type manufactured. Generates a pressure of 200 lbs. with remarkable ease. Solid brass throughout. For spraying trees, shrubs and garden truck; washing autos, windows, fire-fighting, etc. The nozzle has four different spray caps. Pump can be used with bucket or knapsack. Complete with pump, hose, nozzle and strainer, \$5.00.

Galvanized iron knapsack with carrying straps \$3.50; extension rod curved 50c.

Pump, Auto Spray No. 60. Double-acting, high pressure, bucket-pump with air chamber. Price \$7.00

Pump, Kinney's Atomizer. For use in greenhouses to distribute liquid fertilizer or to mix or temper hot and cold water under pressure. \$2.50 each.

Pump (Banner.) Compressed Air. Considered by many the best of all sprayers. Has features found in no other pump of similar make. 4 gallon capacity. Complete as illustrated. With brass tank \$10.00 With galvanized tank \$7.00



DOUBLE BOTTOM -- DOUBLE STRENGTH

FARM, GARDEN AND LAWN REQUISITES, TOOLS, ETC.—Continued

Putty Bulb. For glazing greenhouse sash, \$1.50 each.
Putty, Twemlow's Old English Glazing. A superior article for bedding glass in sash or filling cracks or seams in roof joints, etc. 1 gal., 3 gal. and 5 gal. containers at \$3.75 per gal.
Raffia. The best material for tying. Soft, pliable and strong. 40c. per lb., 10 lbs. 35c. per lb.
Raffia, Green. For tying plants, etc. \$1.75 per lb.
Rakes, Gibbs' Lawn. All steel; reversible, strong and light, 24 teeth, \$1.00 each.
Rakes, Bamboo Broom. Fan shape, 18 in. \$1.00 and 24 in. \$1.25 each.
Rakes, Brume. Steel, fan-shaped rake; used as a broom; strong and durable. Price, \$1.00 each.
Rakes, Dandelion. Keeps lawn free from Dandelion heads, dead grass, etc. Price, \$1.00 each.
Rakes, Hay, Wood. Extra quality, three bow, \$1.10 each.
Rakes, Lawn, Wood. Extra quality. Three bow. \$1.25 each.
Rakes, Steel. Heavy, for roadwork. 14 teeth, \$1.50; 16 teeth, \$1.75.
Rakes, Steel Garden. Long teeth. 10 teeth \$1.00, 12 teeth, \$1.10, 14 teeth, \$1.20, 16 teeth, \$1.25, 18 teeth \$1.35.
Rakes, Steel Lawn. Short teeth. 12 teeth \$1.25, 14 teeth \$1.35, 16 teeth \$1.50, 18 teeth \$1.65.
Sash, Hotbed. Well made from thoroughly seasoned lumber, and glazed with double thick glass. Frame 1 3/4 in., 3x6 ft., \$9.50 each. Crating extra at cost.
Saws, Cross-Cut Disston's. Two-man, filed and set ready for use. 4 1/2 ft. \$4.50, 5 ft. \$5.00, 5 1/2 ft. \$5.50, 6 ft. \$6.00 each. Handles 75c. per pair.
Saws, Cross-Cut, One-Man, Disston's. With supplementary handles. 3 ft. \$3.50, 3 1/2 ft. \$4.00, 4 ft. \$4.50, each.
Saws, Hand. Extra refined spring steel. 22 in. \$3.00, 24 in. \$3.25, 26 in. \$3.50 each.
Saws, Pole Pruning. \$2.00 to \$2.50.
Saws, Pruning. Single and double edge. Extra refined spring steel. 18 in. \$1.75, 20 in. \$2.00 each.
Saws, Wood (Buck). No. 45 complete, with famous "McKenney Triple Cut" blades. \$2.25 each.
Scissors, Flower. For cutting and holding flowers. 7 in. \$2.00 each.
Scissors, Grape or Vine. For thinning the bunch. Nickel-plated, 6 in. \$1.75, 7 in. \$2.00 each.
Scoops, Coal. Extra quality. No. 2, \$2.00, No. 3, \$2.25, No. 4, \$2.50, No. 5, \$2.75, No. 6, \$3.00 each.
Scoops, Furnace, Long Handle. \$1.00 to \$1.50 each.
Scythes, "Witherell's." Finest Cutlery Steel. Fully warranted. \$2.00 each.
Scythes, Broad English, or Lawn. \$3.00 each.
Scythes, Heavy Bush. \$2.25 each.
Scythes, Weed or Bramble. \$2.25 each.
Scythe Snaths. \$1.75 each, bush, \$2.00 each.

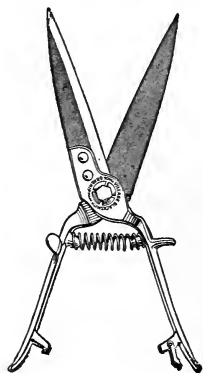

Scythes Stones. Carborundum. 50c. each.
Scythe Stones. English Round. Talaere. 50c. each.
Scythe Stones. "Manchester." 25c. each.
Seed Sower, "Cahoon." Best machine for sowing broadcast, grass seed, oats, barley, etc. \$6.00 each.
Seeder, Wheelbarrow Grass. This seeder is arranged to sow all kinds of grass seed, etc., in any quantity, from 6 to 40 qts. to acre with 14 ft. hopper, \$16.00 each.
Silkalime (Smilax Thread). Spools 40c. each, box of 8 spools, \$3.00.
Shears, "Grasnip." A practical all-around shear for grass, vines, light shrubbery, etc. 6-in. cutlery steel blades \$1.25 each.

Shears, Branch or Lopping. Clyde improved draw cut, the best and strongest shear made. Cuts without crushing.
 No. 1, 22-in. handle.....\$3.25
 No. 2, 24-in. handle..... 3.50
 No. 3, Disston Bull-Dog Double Cut Jaw..... 3.50
Shears, Grass Border. Long handle, 8 in. blade, \$6.00; 9 in. \$6.50, 10 in. \$7.00 each. Long handle wheel, 9 in. blade, \$7.00; 10 in. \$7.50 each. Extra handles, \$1.50 pr.
Shears, Grass or Sheep. \$1.00. English Extra quality. \$2.25 ea.
Shears, Hedge or Grass. English pruning notch. 8 in. blade, \$4.00, 9 in. \$4.50, 10 in. \$5.00 each. Extra handles, \$1.00 pr.
Shears, Lawn or Grass. Long handle, 9 in. \$6.50, with wheels, \$7.50.
Shears, Ladies' Hedge. American 6 in. \$2.50. English \$3.50 ea.
Shears, Ladies' Pruning. 6 in. Rose \$2.00.
Shears, German Pruning. Nickel-plated, lock nut, volute spring. 8 in. \$2.50, 9 in. \$3.00, 10 in. \$3.50.
Shears, Pruning, French. With wheel spring, polished, 7 in. \$2.25, 8 in. \$2.50, 9 in. \$3.00, 10 in. \$3.50. Extra springs 50c. each.
Shovels, Snow. Wood. Malleable iron tip, \$1.25 each.
Shovels, Snow. Steel, either long or D handle, \$1.00 each.
Snow Pusher. Steel, 18 in. curved blade. \$1.25 each.
Snow Scoop. Galvanized steel; 30 in. \$7.50 each.
Shovels, Superior Steel. Round or square pointed. D or long handle, No. 2, \$2.25 each, No. 3, \$2.50 each.
Shovels, Market Gardeners. Lightweight, for banking Celery, etc. Long handle. \$2.00 each.
Sod Lifter. Useful for cutting under sod as it is being rolled. English, spade or heart-shaped. Price \$10.00.
Spades, Superior Steel. Extra quality. Either D or long handle. No. 2, \$2.25 each; No. 3, \$2.50 each.
Stake Fasteners. Galvanized, rust-proof wire. Hold the stakes and cross wires firmly.
Eureka. Small and light; per package of 1,000, \$3.00.
Everlasting. Heavy and strong; per package of 1,000, \$4.50.
Stakes, Japanese Cane. Green. Small and inconspicuous, but strong and useful for plants.

Ft.	Doz.	100	1000	Ft.	Doz.	100	1000
1	\$0.10	\$0.75	\$6.00	3	\$0.20	\$1.50	\$13.00
1 1/2	.12	.85	7.00	3 1/2	.25	1.75	15.00
2	.15	1.00	9.00	4	.30	2.00	18.50
2 1/2	.18	1.25	11.50	5	.35	2.50	23.00

6 ft., Plain, 40c. per doz., \$3.00 per 100, \$28.00 per 1000.
 8 ft., Plain, 50c. per doz., \$4.00 per 100, \$37.00 per 1000.
Stakes, Japanese Bamboo Garden. Very strong and durable, 5/8 to 3/4 in. in diameter. 4 ft. 75c. per doz., \$6.00 per 100; 6 ft., \$1.00 per doz.; 7.00 per 100; 8 ft., \$1.25 per doz., \$8.00 per 100.
Support, "Adjusto" Plant. A small unbreakable and practical support. Adjustable to any height for Tomatoes, Roses, Hydrangeas, Dahlias, etc. Made of hard wood, protected by a coat of green paint and heavy spring wire, also painted green.
 Stakes 7/8 in. square, diameter of wires 13 ins.

	Each	Doz.
3 ft. height.....	\$0.35	\$3.00
4 ft. height.....	.40	3.60
5 ft. height.....	.45	4.20
6 ft. height.....	.50	4.80

 Extra 13-in. wire loops (for use on the taller stakes and plants), 15c. each.

FARM, GARDEN AND LAWN REQUISITES, TOOLS, ETC.—Continued

Stakes, Garden, Painted Green. For house, greenhouse and conservatory.

Light Round Stakes			
Ft.	Doz.	Ft.	Doz.
1½	\$0.35	3½	\$1.25
2	.60	4	1.50
2½	.75	5	2.00
3	1.10		
			100
			\$9.00

Heavy Round Stakes			
Ft.	Doz.	Ft.	Doz.
3	\$1.75	5	\$2.75
4	2.25	6	3.25
			100
			\$20.00
			25.00

Square Stakes			
Ft.	Doz.	Ft.	Doz.
1½	\$0.35	4	\$1.75
2	.50	5	2.35
2½	.75	6	2.75
3	1.00	Ex. heavy 4	3.50
3½	1.25	Ex. heavy 5	4.00
		Ex. heavy 6	5.00
			100
			\$12.00
			17.00
			19.00
			26.00
			30.00
			35.00

Stakes, Square, Unpainted.		Hardwood.	
28 inches long	100	100	1000
36 inches long	\$0.75		\$5.00
48 inches long	1.25		8.00
	1.50		10.00

Sticks, Match. Pine, 5-32 inch thick. Green, 60c. per 100, \$4.50 per 1000.

Styptic, Thomson's (Imported). To prevent the bleeding of grape vines. Per bottle \$1.25.

Tamper. Dirt and sod, high grade. 8x8 base. \$1.15 each.



The New Weed Puller. Out-U-Kum. Guaranteed to remove the root along with the weed. A slight push and a pull does the trick. Price 75c. each.

Twine, Green Linen. For Smilax, 50c. per ball.

Twine, Green Cotton. 25c. per ball, \$2.50 per doz.

Twine, Hard. "For tying parcels." Heavy, medium and light. 50c. per ball, \$5.50 per doz.

Twine, Soft. 35c. per ball, \$3.50 per doz.

Twine, Tarred Marline. Twisted. In 5-lb. and 10-lb. balls. Each 55c. per lb.

Twine, Tarred Yarn (Lathyrn). Excellent for tying shrubs, etc. 30c. per lb.

Twine, White Cotton. 25c. per ball, \$2.50 per doz.

Twine, Yacht Marline. In ½-lb. balls, 50c. each.

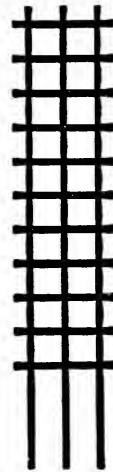

Lattice



Fan

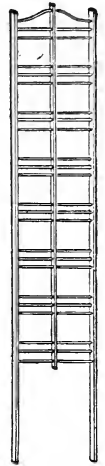

Veranda

TRELLISES

Not carried in stock, but can be shipped promptly from factory. If crating is required in shipment, it will be charged at cost.

Trellis, Tomato. Two hoop; 25c. each, \$2.50 per doz.

Trellis, Tomato, Handy Vine. Made of wood and wire. 40c. each, \$4.25 per doz.

Trellis, Fan.

Height	Each	Doz.	Height	Each	Doz.
1½ ft.	\$0.50	\$4.50	4 ft.	\$2.25	\$22.00
2 ft.	.65	6.00	5 ft.	2.75	28.00
2½ ft.	1.00	8.50	6 ft.	3.25	34.00
3 ft.	1.50	14.00	7 ft.	3.50	38.00
3½ ft.	1.75	16.00	8 ft.	4.00	42.00

Trellis, Veranda. Made of wood and painted dark green, and especially adapted to outdoor use for high climbing vines and roses.

High	Wide	Each	Doz.	High	Wide	Each	Doz.
5 ft.	18 in.	\$2.50	\$25.00	9 ft.	18 in.	\$4.50	\$45.00
6 ft.	18 in.	3.00	30.00	10 ft.	20 in.	5.00	52.00
6 ft.	28 in.	3.75	40.00	10 ft.	31 in.	6.50	70.00
7 ft.	18 in.	3.50	39.00	11 ft.	20 in.	5.50	60.00
8 ft.	18 in.	4.00	42.00	12 ft.	20 in.	6.00	66.00
8 ft.	28 in.	5.00	52.00	12 ft.	36 in.	7.50	86.00

Trellis, Lattice. Made of wood and painted dark green. This style is made to satisfy the increasing demand for a plain yet substantial support which is in harmony with the tendency toward severe lines in architecture. Made in only one width, thus being adaptable around windows and doors, as it can be cut into any desired length.

High	Wide	Each	Doz.	High	Wide	Each	Doz.
6 ft.	18 in.	\$3.00	\$30.00	10 ft.	18 in.	\$5.00	\$50.00
7 ft.	18 in.	3.50	35.00	11 ft.	18 in.	5.50	55.00
8 ft.	18 in.	4.00	40.00	12 ft.	18 in.	6.00	60.00
9 ft.	18 in.	4.50	45.00				

Trowels, Garden, English Genuine. Extra heavy, 6 in., \$1.00; 7 in., \$1.25.

Trowels, Transplanting. 6 in. 25c.; 7 in. 30c.

Trowels, Berry. 4½ in. 60c. each.

Trowels, Flat, Steel. Best steel, 7 in. \$1.50 each.

Trowels, Garden. Extra forged steel. Solid steel blade and shank. 6 in. 65c.; 7 in. 75c. each.

FARM, GARDEN AND LAWN REQUISITES, TOOLS, ETC.—Continued

Truck and Leaf Rack. An extremely useful combination, with 2½ in. tires, \$30.00; 3½ in. tires, \$32.00.

Truck and Water Barrel with 2½-in. tires, \$26.00; 3½-in. tires, \$28.00.

Truck and Hand Cart Box with 2½-in. tires, \$24.00; 3½-in. tires, \$26.00.

Extra Barrels with Trunnions, \$10.00; extra trunnions, \$1.50 a pair.

Leaf Rack only, \$14.00; **Hand Cart Box** only, \$6.50.

Watering Pots. For house use; made of tin painted green and have long spouts. 2 qts. \$1.25.

Watering Pots, English. An ideal pot for watering seedlings, cuttings, etc. 3 qt. \$6.50, 4 qt. \$7.50, 6 qt. \$8.50, 8 qt. \$9.50, 10 qt. \$11.00 each.

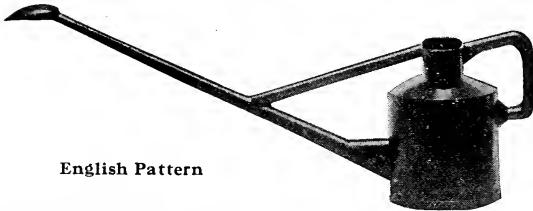

English Pattern

Watering Pots, French. Made of galvanized iron; oval in shape, with brass handle and long spout; one fine and one coarse copper-faced rose with each. 6 qt. \$6.50, 8 qt. \$7.00, 10 qt. \$7.50, 12 qt. \$8.00 each.

Watering Pots, Galvanized Iron. The best watering pot made, for strength, durability and neatness. Made from best quality iron; the top and back handles riveted on; an iron band on the bottom; the spout riveted, and a brace around it riveted to the body, and galvanized after it is made. A coarse and fine copper-faced rose with each pot. Extra rose 75c. Each

- 4 qts., spout 18 in. long..... \$5.50
- 6 qts., spout 21 in. long..... 6.00
- 8 qts., spout 23 in. long..... 6.50
- 10 qts., spout 25 in. long..... 7.00
- 12 qts., spout 25 in. long..... 8.00
- 16 qts., spout 25 in. long..... 9.00

It Sprays Continuously

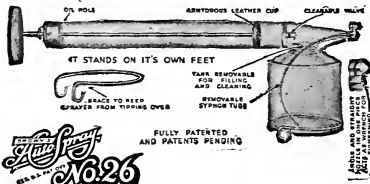

Sprayer and Atomizer. No. 26AG. This glass tank, continuous atomizer is the newest and most practical sprayer of its kind. Operator can always see the exact amount of liquid in the reservoir, and wide mouth opening makes easy filling and cleaning. Supplies on both up and down stroke, and maintains a constant mist, which can be delivered at any angle, with very little effort. 1 qt. Price \$1.25. We also have this style of sprayer made entirely of brass in 3-qt. size. Price of the same \$3.00. Made in 1-gal. size with galvanized tank. Price \$2.50.

Soap Sprayer, Barrie's. Made of solid bronze, heavily nickel plated. Soap is placed in the bowl, the sprayer attached to the faucet and the hose to the sprayer. Water entering the bowl agitates the soap, giving a mild insecticide through the hose, while spraying, never injures the plants and is excellent for destroying green fly, etc., in greenhouse and garden. \$7.50 each.

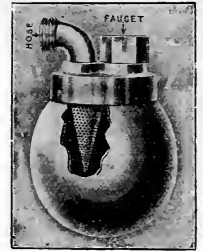

The Double Barrel Duster. For spraying all dry insecticides. Considered the best hand duster on the market. 75c. each.

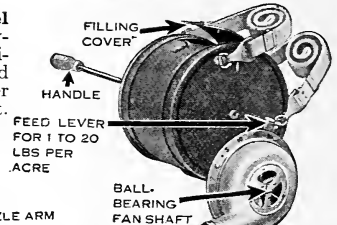

NOZZLE ARM SWINGS UP OR DOWN TO ANY ANGLE

RUBBER NOZZLE WILL NOT DENT OR BREAK

"The Savage Duster." Highly adapted for spraying garden vegetables, shrubbery, plants, etc. Will spray everything in powder form. It sprays easier than any hand duster on the market, requires no lubrication, as all gears and pinions are packed with a special grease, sealed in the gear case, to always insure proper lubrication without attention. It is built of the finest material and workmanship. Will last for several years. Descriptive circulars on request. Price \$20.00.

- Weeders, Baby Warren Hoe.** 60c. each.
- Weeder, Magic.** Hand, 3-tine, 18-in. handle, 25c. each; 36-in. handle, 40c. each; 4-tine, 42 in. handle, 75c. each.
- Weeders, Onion.** Triangle-shaped, 8-in. handle, 3-in. blade, 50c. each. 4-ft. handle, 3-in. blade, 75c. each.
- Weeder, Three-Pronged.** 60c. each.
- Weeder, Excelsior.** 25c. each.
- Weeder, Hazeltine.** Steel blade, with wooden handle. 35c. each.

- Wedges.** Truckee pattern, solid cast steel. 15c. per lb.
- Whiffletrees.** Selected ash. \$1.00 to \$1.50.
- Wire.** Annealed galvanized. No. 14, \$1.75; No. 16, \$2.00; No. 18, \$2.25; No. 20, \$2.50 per stone of 12 lbs., in coils.
- Wrenches, Monkey.** Knife handle. 6 in. \$1.00 each, 8 in. \$1.25 each, 10 in. \$1.50 each, 12 in. \$2.00 each, 15 in. \$2.50 each.
- Wrenches, Stillson.** Length when opened, 6 in. 75c. each, 8 in. 85c. each, 10 in. \$1.00 each, 14 in. \$1.35 each, 18 in. \$2.00 each, 24 in. \$3.00 each.

SINCE 1867
COLDWELL

LAWN MOWERS

HAND—HORSE—MOTOR

CUB

21-inch Cut. Capacity Two to Three Acres per Day

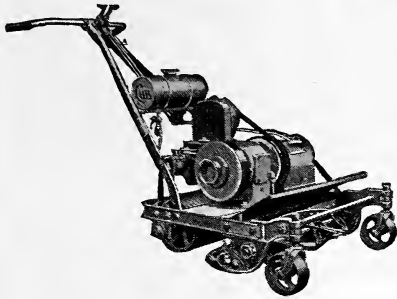

The Coldwell Cub

This machine will readily meet the demand for a light weight easily handled, substantially built, dependable power lawn mower and roller of good capacity at a moderate price. Easily maneuvered around flower beds, trees and shrubbery. Will trim close along walks and driveways. The full width drive roller gives a complete rolling with each cutting, and prevents marring the turf in turning or when cutting while the ground is wet. A great time and labor saver on estates, cemeteries, school lawns and city parks. Completely enclosed four cycle motor, water cooled with radiator and fan, permits full load to be carried continuously in hottest weather. Equipped with automobile type carburetor, and Bosch high-tension magneto. Especially designed and built by Coldwell, and provides an abundance of power for cutting on steep grades,

and in rank or tough grass. A separate clutch is provided for the cutter knives and also the drive roller, and each is controlled by a lever conveniently located on the handle. Demountable cutting unit with five blade revolving cutter, carried on roller bearings. **Weight net, 260 lbs.**

Price, \$195.00, F.O.B. Factory

THE NEW TWIN CYLINDER LINE

25-inch and 30-inch Cut.

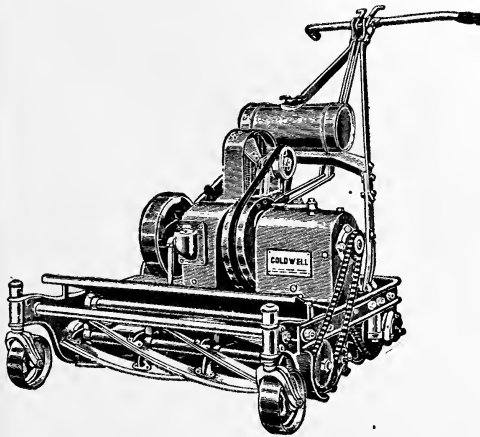

The New Twin Cylinder Line

Suitable for lawns of from four to eight acres, also for baseball parks and athletic fields. Extreme flexibility for trimming and for terrace work. Equipped with two cylinder, four cycle water cooled motor, which provides an abundance of reserve power. Is free from vibration and noise and will develop maximum power continuously in hottest weather without overheating. Full width, two-section drive roller with differential between the rollers to prevent marring and to make turning easy. Riding sulky for the operator, and grass catcher may be had as extra equipment.

"L TWIN"—25-inch cut, four to six acres per day. Weight net, 380 lbs. Price, \$335.00 F.O.B. Factory.

This model may also be furnished with two 20-inch auxiliary gang units, which more than double the cutting capacity. These units may be attached or detached in a moment.

"L TWIN" WITH GANG—60-inch cut, ten to twelve acres per day. Price, \$395.00 F.O.B. Factory.

"TWIN 30"—30-inch cut, six to eight acres per day. Weight net, 420 lbs. Price, \$385.00 F.O.B. Factory.

SPECIFICATIONS

Motor—Twin cylinder, 4 cycle.
Horse Power—5 h.p., S. A. E. rating.
Ignition—Bosch high tension magneto.
Carburetor—Tillotson, Automobile type.
Lubrication—Force feed lubrication with pump.
Bearings—Crank shaft and transmission shaft carried on roller bearings.
Cooling—Water cooled with radiator and fan.

Transmission—Self adjusting, automobile type cone clutches, roller chain drive.

Speed—Governor control. (Maintains constant comfortable walking speed and supplies sufficient power for the load under all conditions).

Cutting Unit—Demountable 5-blade revolving cutter, blades oil tempered.

Height of Cut— $\frac{3}{8}$ to 2 inches.

Owing to limited amount of space we cannot fully describe these machines in our catalog, but will gladly mail a descriptive circular upon request.

COLDWELL LAWN MOWERS—Continued

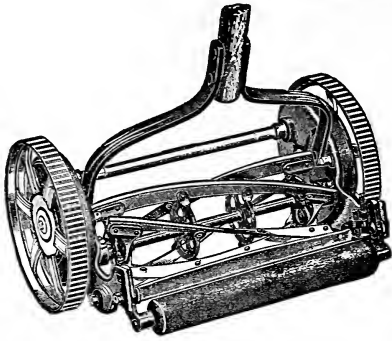

IMPERIAL (TIMKEN TAPERED) ROLLER BEARING. Five Blade. High Wheel. The latest design in Coldwell Hand Lawn Mowers. We consider it the best possible mower on the market for use in parks and cemeteries, where they are expected to do heavy duty; possibly the most durable lawn mower manufactured. This Mower has 10½-in. drive wheels, has the knife bar type of adjustment and is also equipped with the new type of oil-tempered steel-lipped bottom knife; also the revolving cutter blades are oil-tempered. This mower will be of easier draft on account of improved type of bearing and will be more simple of adjustment. Three sizes; 16 in. \$22.00, 18 in. \$24.00, 20 in. \$26.00.

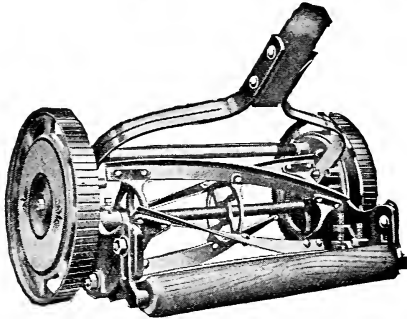

NEWPORT (BRONZE BEARING) LAWN MOWER
Best known and biggest seller of any mower in America in its class. A very durable and satisfactory mower. Four blades. 14 in. \$12.00, 16 in. \$13.00, 18 in. \$14.00.

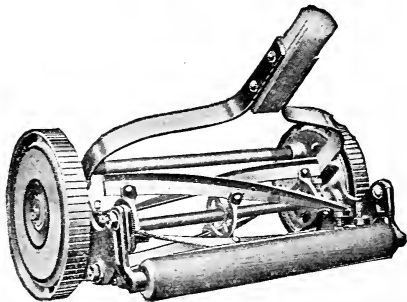

GOLDEN GLOW (BRONZE BEARING) LAWN MOWER. Light weight and very desirable for terraces and small lawns. Built low for close cutting. Excellent value for the price asked. 14 in. \$10.00, 16 in. \$11.00, 18 in. \$12.00.

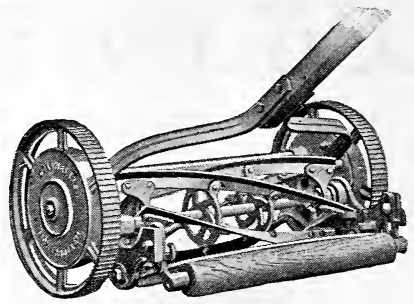

KNICKERBOCKER (BALL BEARING) LAWN MOWER. A high grade, five-blade, 10-in. wheel, ball-bearing mower moderately priced. A light running, well-balanced machine. Good value for use in parks, cemeteries, schools, homes, etc. Finest drop-forged steel, case-hardened ball bearings. Shouldered tie rod with nut holds frame rigid. Special steel bottom knife. Height of cut, ½ to 1½ in. 16 in. \$18.00, 18 in. \$20.00.

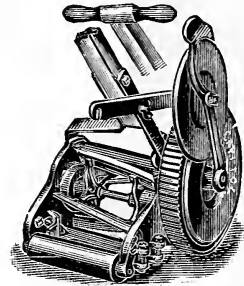

THE "CAPITOL" TRIMMER AND EDGING MACHINE. It does what no other machine can do and what lawn mowers leave undone. It trims and edges the lawn in the quickest possible time. The greatest labor saving gardener's tool on the market. Price \$12.00.

WE ARE THE ONLY IMPLEMENT AND SEED HOUSE IN BOSTON THAT HAS AN UP-TO-DATE LAWN MOWER REPAIR DEPARTMENT, LOCATED IN OUR OWN ESTABLISHMENT AND OPERATED BY OUR OWN MECHANICS WHO THOROUGHLY UNDERSTAND THIS LINE OF WORK.

With its improved facilities for resharpening, repairing, and adjusting hand, horse, and motor mowers, we solicit your patronage, and suggest that you be very careful with whom you trust your mowers for sharpening and adjusting. To insure reasonable delivery, early shipments are suggested. Please note what you wish especially done to your mower, on the tag or by letter. In cases where this is omitted, we will sharpen same and put in good order. Please remove handles, when convenient, before shipping. Special tags, which you will find convenient in sending your mower, will be mailed on request.

LAWN MOWERS—Continued

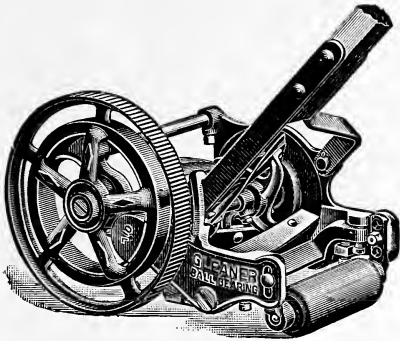

TOWNSEND'S "GLEANER" BALL BEARING. Strong, light and powerful. We warrant it the best trimmer on the market. Only $\frac{1}{8}$ in. of metal between ends of blades and any obstruction to be cut around. 9-in. wheel, 4 blades. Width of cut 8 in. \$9.00 each.

TOWNSEND'S FINISHER, BALL BEARING. A high-grade light trimmer, made for those who have but a little trimming to do. Has 7-in. wheel, 3 blades. Width of cut 5 in. \$7.00.

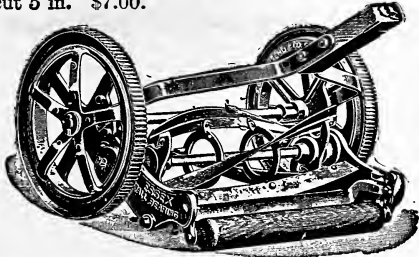

ESSEX LAWN MOWERS, BALL-BEARING. We submit this mower as the highest type of a double gear grass cutting machine. The 11-in. drive wheels make it the easiest running mower in the world. It is made with a reel or wiper of over 6 in. in diameter (four blades) which enables the user to cut much higher grass than can be cut by the ordinary mower. 14 in. \$17.00, 16 in. \$19.00, 18 in. \$21.00, 20 in. \$23.00.

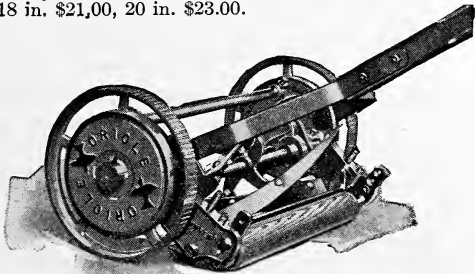

ORIOLE BALL-BEARING LAWN MOWER. This is a high-grade, lightweight, easy running mower. Made especially for bankings and terraces. It has four oil-tempered blades, 8-in. closed type drive wheels and is made of the same quality material as the higher price mowers. Made in two sizes. 12 in. \$8.50, 14 in. \$10.00.

RED BIRD, BALL-BEARING. A splendid machine at low price. It is easy running. It is light, strong and durable. Quiet in action, easy of adjustment, and does excellent work. $9\frac{1}{2}$ in. wheel, 4 blades. 16 in. \$12.50, 18 in. \$14.00.

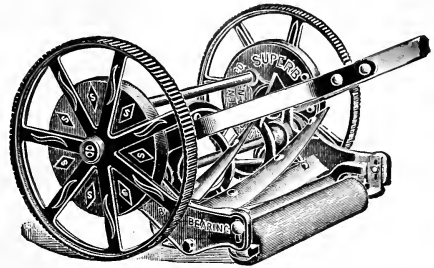

TOWNSEND'S SUPERB BALL-BEARING LAWN MOWER. The highest wheel (12-inch), easiest running, large, hand lawn mower in the world. Built to meet the most exacting requirements in all localities. Quiet in action, easy of adjustment, and does excellent work. Has five blades. 18 in. \$24.00, 20 in. \$26.00, 22 in. \$28.00.

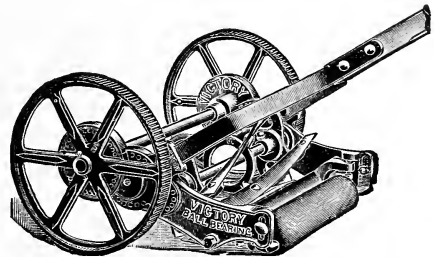

VICTORY BALL-BEARING LAWN MOWER. 10 in. wheel, 4-bladed reel, construction light; easily run and almost silent. 14 in. \$17.00, 16 in. \$19.00, 18 in. \$21.00, 20 in. \$23.00.

GRASS CATCHERS. Will fit any style of lawn mower, 14 in. and 16 in. \$2.00 each, 18 in. and 20 in. \$2.50 each.

We are authorized distributors for the following manufacturers:

COLDWELL LAWN MOWER COMPANY:
Hand, Horse, and Motor Lawn Mowers.

S. P. TOWNSEND COMPANY:
Ball bearing Lawn Mowers.

INTERNATIONAL HARVESTER COMPANY:
McCormick-Deering Harvesting Machines,
Tillage Implements, etc.

HUSSEY PLOW COMPANY:
Cultivators, Plows, and Stone Boats.

C. S. NORCROSS & SONS:
Hand and Wheel Garden Cultivators, and
Weeders.

BATEMAN BROTHERS, INC.
IRON AGE Hand Cultivators and Seeders,
Fertilizer Distributors.

IRON KING IMPLEMENT COMPANY:
"IRON KING" Hand Fertilizer Distributors,
and Seeders.

COLUMBIAN ROPE COMPANY:
Columbian Tape-Marked Pure Manila Rope.

BUCH MANUFACTURING COMPANY:
Lawn Rollers and Wheelbarrows.

Farm and Garden Tools and Implements

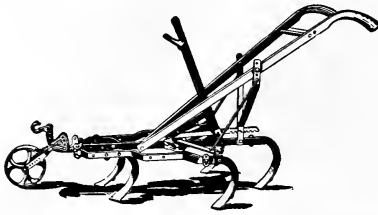

CULTIVATOR, McCORMICK-DEERING

McCormick-Deering 1-horse cultivators can be supplied in 5-, 7-, and 9-shovel and 14-tooth, with a variety of special equipment that adapts them to the needs of those sections where the work is done with one horse. For the cultivation of all farm and garden crops, they cannot, so far as quality of work is concerned, be beaten by any other type of cultivator. We would call particular attention to the superior form of construction by which the cultivator may be varied from the narrowest to the widest position with one motion and with no change of bolts, and when closed up does not get on dead center or become difficult to open. Prices on application.

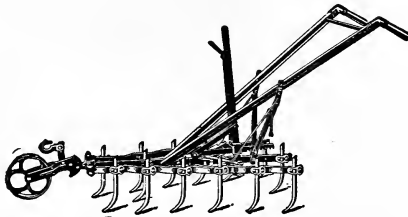

CULTIVATOR, McCORMICK-DEERING, SPIKE-TOOTH

A strongly built cultivator. Teeth clipped rigidly to bars and adjustable to three angles of penetration. Especially adapted to pulverize the soil and leave it smooth and level. The teeth are reversible and the pitch can be quickly changed forward or back by simply loosening one bolt at each tooth. Expanding lever, 14 teeth and wheel. Price of same \$12.00.

NEW MODEL CENTENNIAL

The "New Model Centennial" Horse-Hoe, Cultivator and Coverer combined, has long been recognized as an Implement of unusual merit. The simplicity and fewness of parts required for changing it over to suit the various kinds of work to which it is adapted, and its unique and very efficient Expansion Device are among the reasons for its popularity.

No. 8. Has 8 one-inch points, long wings and expander. Price, \$18.00.

No. 1. Has 5 three-inch points, long wings and expander. Price, \$16.00

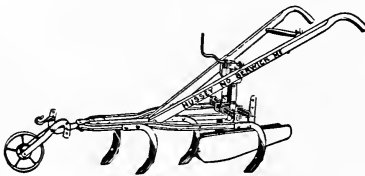

HARROW, McCORMICK-DEERING, SPRING TOOTH, WITH LEVERS

9-tooth, 1-horse, with handles, weight 126 lbs.	\$18.00
15-tooth, 2-horse, two sections, weight 210 lbs.	27.00
17-tooth, 2- or 3-horse, two sections, weight 228 lbs.	28.50
Sulky attachment for 15- and 17-tooth Harrows.	15.00



HARROW, McCORMICK-DEERING DISC

For crushing clods, pulverizing hard-baked clay land, or cutting up sod ground, no harrow rivals this one. It is made with a much stronger frame than the ordinary type of disc harrow, being made of a heavy angle steel cross-bar to which draft links are fastened. Made with either solid or cutaway discs. It is made in different sizes for horses or tractors. Can be supplied with fore carriage and transportation trucks or separate if desired. Prices on application.

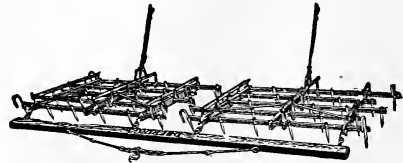

HARROW, McCORMICK-DEERING, PEG-TOOTH

This harrow can be used with great success on stony ground. Teeth can be quickly set at any desired angle by the lever. One section, with evener, for one horse, \$14.00; two sections with evener, for two horses, \$26.00.



MEEKER SMOOTHING DISC HARROW

Designed especially for market gardeners' work. A perfect harrow and landroller combined. The frame measures 6 ft. 8 in. by 6 ft., and has four sets of rollers, having 58 steel discs 8 in. diameter on them. The discs grind all the lumps so fine that the seed must come up, leveling and leaving the land fine and smooth and does its work far better than the rake. Price, \$40.00.

FARM AND GARDEN TOOLS AND IMPLEMENTS—Continued

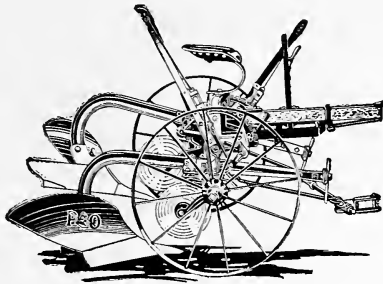

P. & O. SUCCESS SULKY PLOW

Throws all furrows the same way. Leaves no dead furrows. The Two-Way Success has a right and a left hand bottom. Instead of plowing around the land, it plows on the same side all the time, using the right hand bottom one way and the left hand bottom returning. This method leaves the land in a "solid body," eliminating dead and back-furrows. It is, therefore, the proper plow for hillsides, irrigated fields and irregular fields, though it is equally efficient as a general purpose sulky. Equipped for two or three horses. Price \$115.00.



THE CHATTANOOGA STEEL HILLSIDE PLOW

The very latest series of steel hillside plows manufactured. They are the result of years of experiment and for strength, lightness and ease of draft cannot be equaled; while intended for hillside work, will do equally as good work on level land.

- No. 208. 1-Horse Plow with wheel.....\$18.00
- No. 209. 2-Horse Plow, complete with cutter or jointer..... 28.00



THE COMBINATION STEEL BEAM LANDSIDE PLOW

The latest and most up-to-date steel landside plows on the market. Furnished with jointers or cutters, as desired

- No. 97. Regular two-horse. Complete.....\$30.00
- No. 100. Regular two-horse, same as above, but with shorter beam. Specially adapted for stony ground. Complete... 30.00

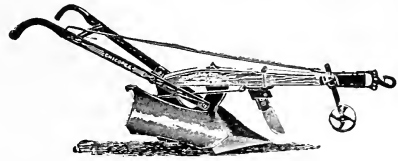
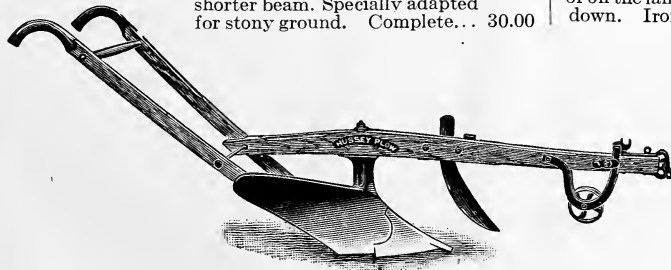

THE ORIGINAL 76 WOOD BEAM HILLSIDE PLOW

This pattern of the popular A. B. C. Series is of light weight and thoroughly constructed. The woodwork is cut from clear, straight-grained, well-seasoned hardwood; handles can be raised or lowered. Has automatic cutter, shifting lever clevis and a spring foot latch. Made in two sizes.

- B. Regular two-horse, complete with wheel and cutter.....\$26.00
- C. One-horse, complete with wheel and cutter.... 18.00

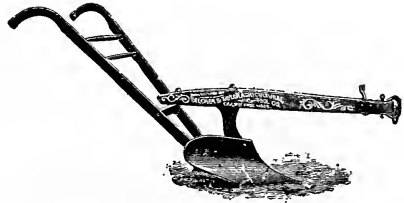

THE ONE-HORSE WOOD BEAM PLOW

Beam adjustable so that the horse can walk on the land or in the furrow. Price

- No. 1. One-horse plow. Will turn furrow 5 1/2 inches by 11 inches.....\$15.00
- No. 52. Grey's Special. Regular, one-horse plow with wheel..... 17.00

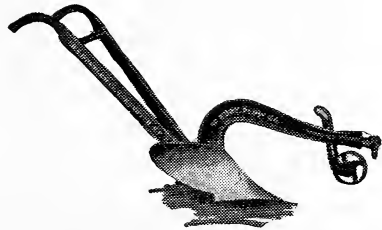

THE VINEYARD AND GARDEN PLOW

Chilled wearing parts. Horse can walk in the furrow or on the land. Handles can be adjusted sideways or up and down. Iron beam, one-horse, with wheel, \$15.00.

PLOWS, HUSSEY HARD METAL

- No. 100. One-horse. Furrow 5 to 6 in. deep, 10 in. wide.....\$16.00
- No. 102. Light two-horse. Furrow 5 to 7 in. deep, 12 in. wide..... 18.00
- No. 104. Medium Sward. Furrow 8 in. deep, 16 in. wide 24.00

FARM AND GARDENS TOOLS AND IMPLEMENTS—Continued

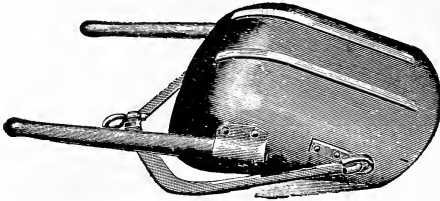
**AMERICAN STEEL DRAG SCRAPER**

Our late addition of a steel drag scraper is of an improved pattern and made without seam or lap, pressed from a single plate of steel. The bowl is well rounded at the sides and curved upward to form the back. They are strong and substantial and made in three sizes. No. 1, 7 cu. ft., \$13.00; No. 2, 5 cu. ft., \$12.00; No. 3, 3 cu. ft., \$11.00.

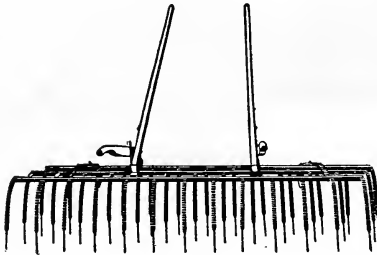
**7 1/2-FT. HORSE WEEDER**

By the use of weeders much time and labor are saved, and better crops grown. They will not cut the roots of the crop, but cultivate just deep enough to retain the moisture, where it is most needed. It is good policy to use the weeder after a heavy rain, when the ground has been beaten down. Use the weeder early and often and you will be surprised at the results. Price, \$18.00.

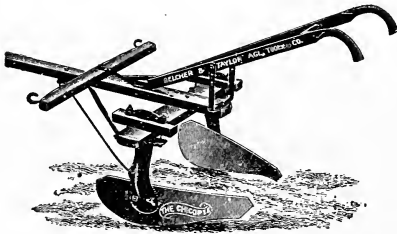
**THE SHOVEL POTATO HOE**

It is made to meet the demands of large growers of potatoes, being designed both for hilling and covering purposes. The blades are of steel and can be tilted upward to assist in shaping the hill, also can be moved upon the cross-bar when necessary. The frame is of hard wood, thoroughly constructed and braced. The handles are adjustable to suit the height of the user and can be moved to right or left so that the operator may walk between the rows. Price, \$18.00.

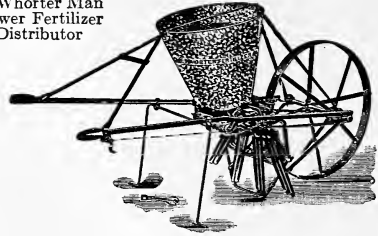
**McWhorter Man
Power Fertilizer
Distributor****MCWHORTER HAND FERTILIZER DISTRIBUTOR**

It will distribute, broadcast, or in furrows, or between rows, or both sides of 1, 2, 3 or 4 rows, according to their distance apart at one operation. Any commercial fertilizer can be applied with it at any desired weight, from 3 to 40 lbs. per 100 yards of row. The fertilizer is forced through eight distributing spouts, which may be contracted to cover a 4 in. strip, or they may be spread into any position not exceeding 2 1/2 ft. in width. We call special attention of this ability to spread the fertilizer with this machine; especially recommended for top dressing strawberries. It makes a beautiful and uniform spread of the fertilizer in row or bed of strawberries up to 2 1/2 ft. wide. The distributor is light, made rigid and strong, and is easy and pleasant to use by man or boy. Price \$22.00

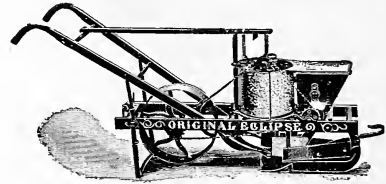
**KING OF THE CORNFIELD AND
ECLIPSE CORN PLANTER AND FERTILIZER
DISTRIBUTOR COMBINED**

For planting field or ensilage corn, beans, peas or beet seeds, in hills or drills with check. Will accurately distribute all commercial fertilizer, wet as well as dry, pulverized hen manure, plaster, ashes and other fertilizers of like consistency, with a certainty. Has concave plates each side of plow, which are of great importance in placing moist earth on the seed, just before the fertilizer is dropped each side of seed. A great advantage in a dry season. Price, \$45.00.

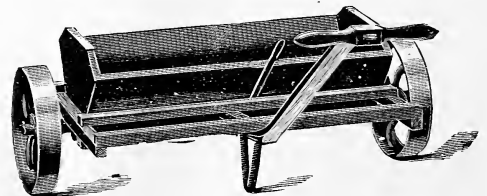
**FERTILIZER SOWER, THE STEVENS' HAND**

Does the work perfectly, sowing all kinds of lawn dressing and other commercial fertilizers, wood ashes, lime, etc., in large or very small quantities. It can also be successfully used for fertilizing strawberry beds, and other garden or field work; is excellent for sifting wood or coal ashes, sawdust, or dry sand on icy walks; will sow damp sand by removing two blades. The hopper is 34 in. long and holds 1 1/2 bus. Weight of machine, 83 lbs. It is well made and nicely painted. Price, \$25.00.

FARM AND GARDEN TOOLS AND IMPLEMENTS—Continued

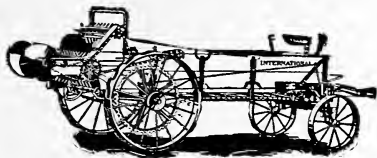

MANURE SPREADER, McCORMICK-DEERING

The McCormick-Deering Spreader is easy pulling and light in draft because it spreads wide from a box that tapers 1½ inches from front to rear, the rear end being wider than the front, which prevents manure from lodging against the box sides. Made in two sizes: No. 1, capacity, 50 bus. and up, furnished with 2-horse hitch; No. 2, capacity 65 bus. and up, furnished with 3-horse hitch. Prices on application.

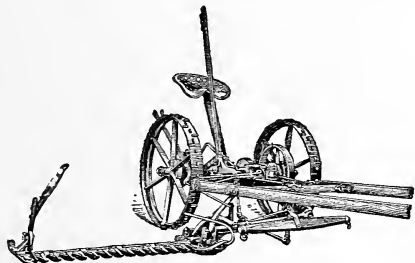

MOWER, McCORMICK-DEERING ONE-HORSE

This gives entire satisfaction on farms, salt meadows and orchards. Many of the parks use it. It is fitted with ball bearing rollers, long wooden pitman, forged steel couplings, a positive and direct stroke. Its action perfectly free, which makes it the most durable, easy of handling and lightest draft mower made. Cuts 3½ and 4 feet. The foot lift cannot be surpassed. The knives and section are made from a special grade of steel. They are stamped with the name, a satisfactory guarantee. Price on application.

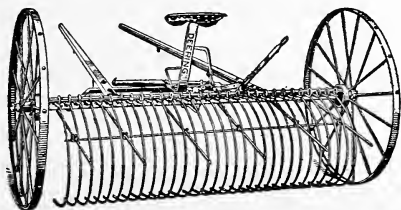

HAY RAKE, McCORMICK-DEERING

This self-dump rake is well built, sturdy and will stand up and do the work successfully under the most severe raking conditions. The best quality of steel is used throughout, and the wheels are large, durable, and well made. Price on application.

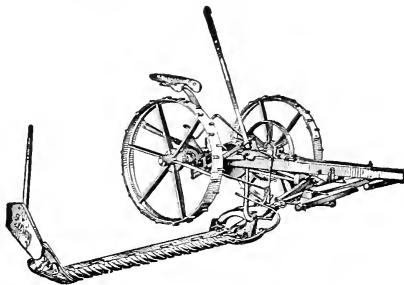

MOWER, McCORMICK-DEERING TWO-HORSE

Weight properly distributed is absolutely essential in mowers to insure machines that will do satisfactory work under all conditions. The working parts of these mowers are made of the best steel, malleable and wrought iron. The pitman is long and strong, made of well seasoned second-growth hickory. The wheels are high and powerful, are connected by a heavy steel axle. The frame is staunch and wide, striding the cut grass, so that the wheels travel in a clear track. Roller and ball bearings make these mowers so light in draft that it is a worthy example of the well-known line of machines. These mowers have a perfectly floated cutter bar; a coil spring not only assists the operator in raising the cutter bar but takes just enough of the weight of the cutter bar off the ground to permit the bar to float with perfect ease and freedom. Price on application.

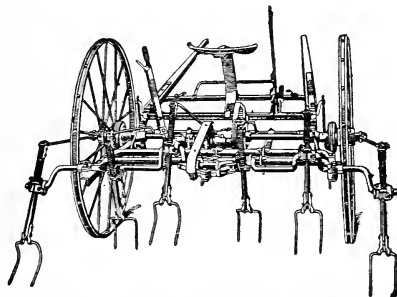

HAY TEDDER, McCORMICK-DEERING

Every farmer can secure a first-class quality of hay if he uses a hay tedder. Tedded hay brings higher prices in the market, for the reason that it is cured in the correct way, and therefore makes a better dry feed for cattle and horses. Price on application.

NORTHLAND STONE BOATS AND HEADS

Strongly bolted. Heavy wood work; made in two sizes; 6 feet and 7 feet in length and 32 inches in width. This boat has a steel head. The wood part is made from rock maple and the whole thing is thoroughly well bolted, making the very best pattern of stone boat in the market. The heads are equipped with a full set of bolts. Prices: 6 ft. boat \$18.00, 7 ft. boat \$22.00; heads alone with bolts, \$8.00.



Hand Garden Tools and Seeders

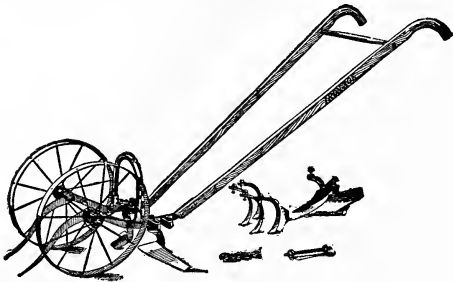

NO. 301 DOUBLE AND SINGLE WHEEL HOE

The garden or farm is incomplete without at least one of these. In cultivating onions, beets, turnips, radishes, etc., it is invaluable; saves hours of hard labor and does the work better than several men could do it in the same time. One great advantage which this double wheel hoe possesses is that it can be made into a single wheel hoe in a moment's time. An axle is sent with every double wheel hoe for this purpose. The wheels are 16 inches high, enabling the wheel hoe to run easily and without yielding to the depressions of the soil, as a low wheel will do. The frame being made of tubing coupled to malleable castings gives great strength, together with lightness. Price \$12.50.

No. 303. The same tool as 301 without vine lifters, cultivator teeth or plows. Side hoes only. \$9.50.

No. 313. The same tool as 301 without plows or vine lifters. Side hoes and four cultivator teeth only. \$10.50.

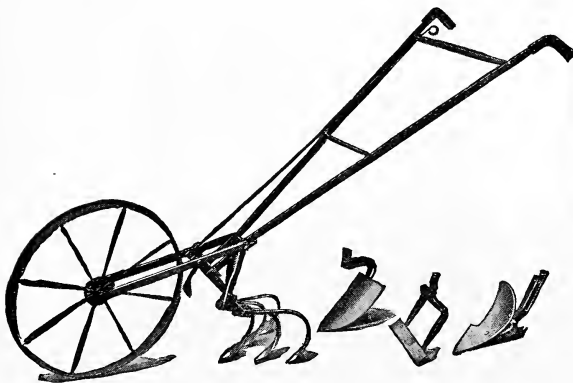

NEW "NORCROSS" NO. 3-ABC ALL METAL GARDEN WHEEL CULTIVATOR

No wabble, quick adjustments. You clean your wheel as you go along. The "New Norcross" garden wheel cultivator is just what the gardener has been looking for—a medium-priced, light, strong, properly balanced implement that pushes easy and steady, thus saving time and labor and insuring better crops.

Attachments: The "New Norcross" has for its main attachment the famous "Norcross" 5-prong cultivator (with heavy steel prongs) acknowledged by gardeners as the greatest cultivating instrument ever designed.

A moldboard plow made of heavy material, has a genuine landside, and the correct shape throughout for best results.

Also a large 5x9-inch oval shovel for laying off rows, deep plowing and hilling—and a 9-inch steel surface weeding blade, set at a slanting angle for keen cutting. Price complete, \$6.50.

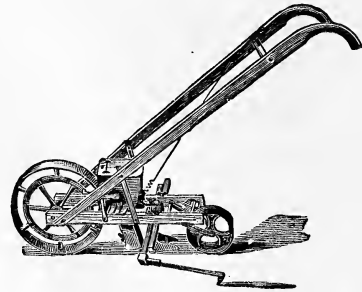

THE NEW MODEL SEED DRILL

This we consider the simplest and best drill on the market. The diamond-shaped adjustable hole regulates the discharge, and can be made larger or smaller as occasion requires. No other drill has this advantage. The seed cut-off claps up underneath the hole; it does not slide under the same, as in other similar drills; on this account it does not clog nor cut the seed. It has a broad wheel and a covering roller. The opening plow is adjustable in depth. The whole makeup of the drill is simple. It can be worked by anyone. Price \$15.00.

IRON KING STEEL FRAME SEEDER NO. 4

This seeder is constructed of steel, has fewer parts and is less complicated than any other seeder. It has a V-shaped shoe, which makes it possible to sow all seed in an exact line and at a uniform depth. Price, \$15.00.

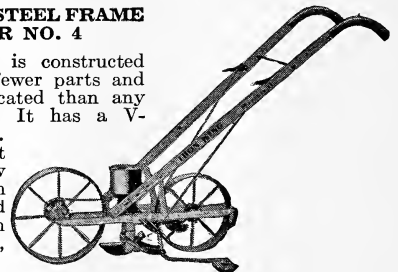

NO. 306 COMBINED HILL AND DRILL SEEDER DOUBLE AND SINGLE WHEEL HOE

Many men should use combination tools for two reasons: They save in first cost and they take up less room.

Thousands of gardeners have found this to be true of No. 306. Of course, most market gardeners prefer to have separate tools always ready to do each separate piece of work—drills, wheel hoes, wheel plows, etc. We have them in great variety, to suit each purpose in a particular way. Complete \$22.00.

FARM AND GARDEN TOOLS AND IMPLEMENTS—Continued



IRON KING FERTILIZER, DISTRIBUTOR AND SIDE DRESSER, No. 39A

This machine is simply and strongly built. The feed spouts are adjustable 2 inches up and down, also sidewise, to enable the operator to vary the width and depth the fertilizer may be sown. The spouts act as furrow openers and fertilizer conveyors at the same time. The double agitators act also as crushers, which is a very desirable feature where fertilizer is very lumpy. It will distribute fertilizer in amounts from 50 to 1,500 lbs. per acre. The hopper holds approximately 32 lbs. Price \$22.00.

..❖-----❖..

South Hanson, Mass., May 7, 1927.
 Thomas J. Grey Company
 16 South Market Street
 Boston, Mass.

Gentlemen:
 I received my Norcross Garden Cultivator and it is the best cultivator I ever used.
 Mail catalog to my brother, Frank F. Corning, R. F. D. No. 5, Manchester, N. H., who desires to purchase one of these cultivators.

Respectfully yours,
 (Signed) Sam P. Corning,
 South Hanson, Mass.

..❖-----❖..

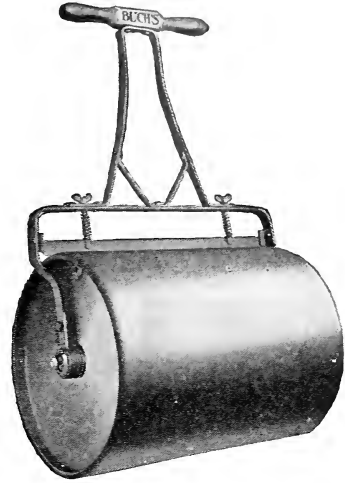

WATER BALLAST LAWN ROLLERS

Adapted for rolling lawns, golf courses and tennis courts. Light running, round edge. No tearing up of sod. Scraper to keep surface clean. Roller bearings in the following sizes:

No.	Diam. Inches	Length Inches	Weight Empty	Filled with Water	Price
601.....	14	24	70	175	\$17.00
602.....	18	24	85	265	20.00
603.....	24	24	110	420	23.00
604.....	24	32	130	566	26.00

Plain bearings in the two sizes below:

605.....	14	24	68	175	\$13.50
606.....	18	24	82	265	16.00

**Columbian
 Tape-Marked
 Pure Manila
 Rope**

Look for the
 Red, White, and
 Blue Tape Marker

**COLUMBIAN "THE
 GUARANTEED ROPE"**

Warranted pure Manila.
 In various sizes. Market
 price.

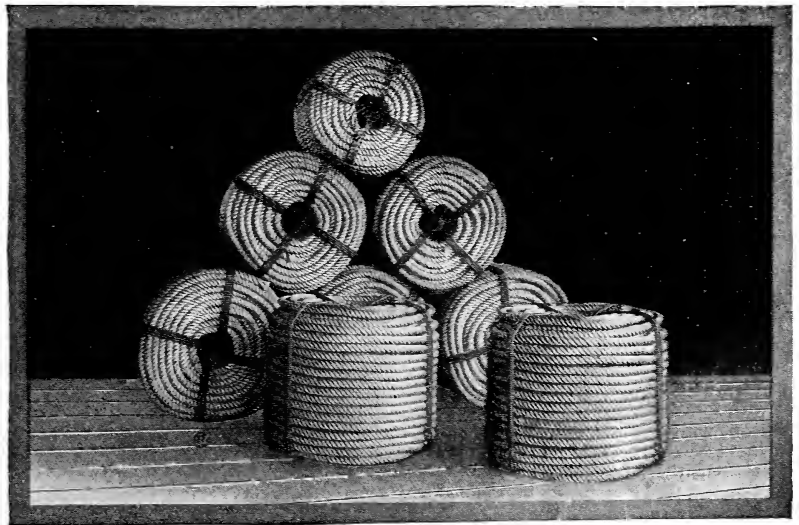

Oilskin Clothing, Etc.

When spraying with lime sulphur, arsenate of lead or other solutions, a waterproof suit is essential to protect the flesh and clothes. Those we offer are especially designed for men who work at spraying or whose work takes them into wet places and who require light-weight, waterproof garments.



Cape Ann Hat

- | | |
|--|------|
| Oilskin Hats (Sou'wester). Either yellow or black..... | 1.25 |
| Waterproof Dressing for Oilskins, Either yellow or black. 75c. per can. | |

- | | |
|--|-------------|
| Oilskin Long Coats. Either yellow or black..... | Each \$6.50 |
| Oilskin Jackets. Either yellow or black..... | 3.50 |
| Oilskin Pants. Either yellow or black..... | 3.50 |

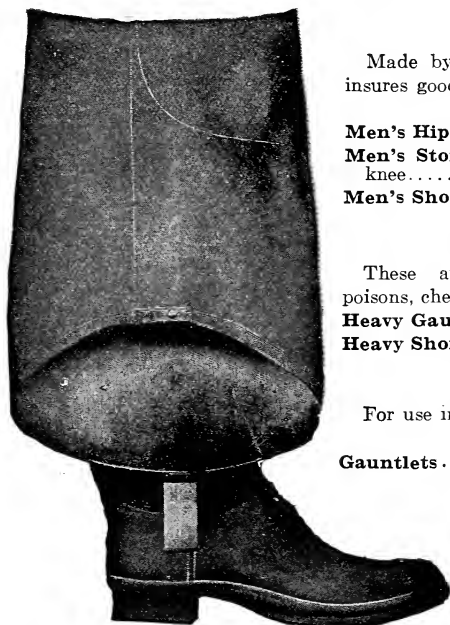

Rubber Boots

Rubber Boots

Made by the Franklin Rubber Co., which insures goods of the finest quality.

- | | |
|---|----------|
| | Per pair |
| Men's Hip Boot | \$9.00 |
| Men's Storm King. Comes just above knee..... | 8.00 |
| Men's Short Boot | 7.00 |

Rubber Gloves

These are indispensable when handling poisons, chemicals, etc.

- | | |
|-----------------------------|----------|
| | Per pair |
| Heavy Gauntlet | \$4.25 |
| Heavy Short | 3.75 |

Leather Gloves

For use in spraying, pruning or garden work.

- | | |
|------------------------|----------|
| | Per pair |
| Gauntlets | \$3.00 |

Goggles

To protect the eyes when spraying. \$1.25 each.



Oilskins

- | | |
|--------------------|----------|
| | Per pair |
| Short | \$2.00 |

Pomona Spray Pump

The Pomona has sufficient capacity to supply two leads of hose and four nozzles. The plunger, plunger connection, gland, valves, valve seats and strainer are of solid bronze. All working parts are simple and so located that they can be easily removed and cleaned. The air chamber is of steel and has a large capacity, making it easy to maintain the pressure and giving smooth operation. The lever can be adjusted for a 3, 4 or 5 inch stroke, the adjustment being obtained by removing and replacing a single bolt. The agitator is very simple but effective, and is operated by the pump lever.

- | | |
|--|---------|
| | Price |
| Pump , with agitator and hose couplings..... | \$24.00 |
| Pump , with agitator and one lead of 15 feet 1/2-inch discharge hose with spray nozzle..... | 30.00 |
| Pump , with agitator and two leads of 1/2-inch discharge hose with spray nozzle..... | 36.00 |
| Either of the above mounted in Barrel for \$12.00 extra. | |
| Extension Rod. Bamboo, brass-lined with stop-cock..... | 4.00 |

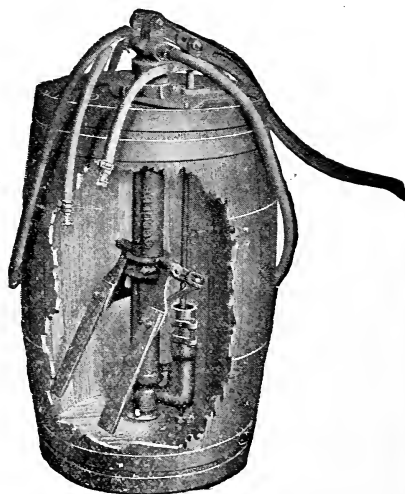

Pomona Spray Pump



Bowker Fertilizers and Stockbridge Manures.

These well-known brands have been manufactured and used with the greatest satisfaction for more than half a century. They have stood the test of time and we can heartily recommend them to all our customers.

All prices subject to change without notice



Stockbridge Early Crop Manure, 5-8-7. A fertilizer especially adapted to soils lacking nitrogen and for use with all root and other vegetable crops. 100 lbs. \$3.50, ton \$60.00.

Stockbridge Hill and Drill Fertilizer, 4-8-7. A well-balanced fertilizer for poor soils or for those either lightly or occasionally manured. It is excellent for Sweet Corn, miscellaneous vegetables and most small fruits. 100 lbs. \$3.25, ton \$57.00.

Bowker's Market Garden Fertilizer, 4-8-4. For vegetables and small fruits where a good balance of the three plant foods is desired. A good, high-grade fertilizer to use where moderate applications of manure are occasionally made. 100 lbs. \$3.00, ton \$55.00.

Bowker's Potato and Vegetable Phosphate, 2-9-3. Well adapted to potatoes or garden crops on rich soils, or on those where moderate to heavy applications of manure have been made in recent years. 100 lbs. \$2.75, ton \$45.00.

Corn Favorite, 3-10-6. This fertilizer, because of its very high content of available phosphoric acid and potash, is admirably adapted for early sweet corn or for promoting the early maturity and high quality of truck crops. 100 lbs. \$3.00, ton \$55.00.

Stockbridge Potato and Vegetable Manure, 4-6-10.

Well adapted to poor or lightly manured soils—especially for Potatoes, Beets, and for many foliage crops, except Cabbage, which requires considerably more available phosphoric acid. 100 lbs. \$3.35, ton \$59.00.

Bowker's All-Round Fertilizer, 3-8-4. True to its name, this is an excellent fertilizer for practically all crops on fairly rich soils or on those that have had only light applications of manure. 100 lbs. \$3.00, ton \$50.00.

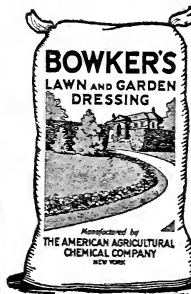

Bowker's Special Ground Bone.

An excellent material for use where gradual but long continued effects of nitrogen and phosphoric acid are desired, as under and around perennials, trees and shrubs, or before seeding to grass. 100 lbs. \$4.00, ton \$70.00.

Bowker's Lawn and Garden Dressing, 5-8-7.

A chemical fertilizer built especially for lawn and garden use. It is quick in action and carries through; an aid in producing a compact velvety dark green sward. 10-lb. bag 90c., 25-lb. bag \$1.50, 50-lb. bag \$3.00, 100-lb. bag \$5.00.

Agricultural Chemicals and other Fertilizers

A.A. Superphosphate. 16 per cent. soluble and available phosphoric acid. 100 lbs \$2.00, ton \$35.00.

Ashes, Unleached Hardwood. High in potash. In bags, per 100 lbs. \$3.00, per ton \$50.00.

Blood Tankage. 12 per cent. \$7.00 per 100 lbs.

Bon Arbor. Immediately soluble in water. A complete plant food, containing nitrogen, potash and phosphoric acid in sufficient quantities. 1 lb. pkg. making 30 gals. 60c., 5 lbs. \$2.50.

Bone, Coarse or Cracked. Ground coarse for Grape borders or poultry. 100 lbs. \$6.00.

Charcoal. Coarse and fine. 10 lbs. 75c., per 100 lbs. \$5.00.

Clay's Fertilizers. This valuable imported manure is especially recommended to all who grow either fruit, flowers or vegetables and wish to bring them to the highest perfection. 14 lbs. \$2.25, 28 lbs. \$4.25, 56 lbs. \$8.00, 112 lbs. \$15.00.

Chrysanthemum Manure, Thomson's Special. Entirely soluble and very powerful, especially suitable for top-dressing Chrysanthemum and similar plants. Price, 7 lbs. \$1.75, 14 lbs. \$2.75, 28 lbs. \$4.50, 56 lbs. \$8.00.

Lime, Agricultural. An unusually pure calcium lime, especially prepared for use on the soil. Shipped in the form of a dry powder in bags of 50 lbs. each. Per 100 lbs. \$1.50, ton \$22.00.

Muriate of Potash. 50 per cent actual potash. 100 lbs. \$6.00.

Nitrate of Soda (Reground). 10 lbs. \$1.00, 25 lbs. \$2.00, 50 lbs. \$3.50, 100 lbs. \$6.50.

Premier Brand Pulverized Poultry Manure. Guaranteed analysis: Nitrogen 4.93 per cent, Equivalent to Ammonia 6.00 per cent, Total Phosphoric Acid 2.75 per cent, Available Phosphoric Acid 2.50 per cent, Potash 1.30 per cent. 1-lb. box 15c., 5-lb. box 50c., 25 lbs. \$1.25, 50 lbs. \$2.25, 100-lb. bag \$4.00, 500 lbs. \$16.00, per ton \$60.00.

Salt. Top-dressing for lawns and Asparagus beds. Price per bag about 140 lbs. \$2.50.

Sheep Manure Pulverized, "Special Brand." This brand has no objectionable odor; it is a pure natural manure, and the most nutritious food for plants. It makes the richest, safest and quickest liquid manure, without any deleterious effects. Minimum guarantee, 2½ per cent Ammonia, 1½ per cent Phosphoric Acid, 1¼ per cent Water Soluble Potash. 5 lbs. 35c., 10-lb. pkg. 60c., 25 lbs. \$1.00, 50 lbs. \$1.75, 100 lbs. \$3.25, ton \$55.00.

Soot, Imported Scotch. Prevents mildew when mixed with sulphur at the rate of one-third sulphur and two-thirds soot; also a good fertilizer. Sold only in original bags at 7c. per lb.

Sulphate of Ammonia. 25 per cent ammonia, \$6.00 per 100 lbs.

Vine, Plant and Vegetable Manure, Thomson's. A safe and reliable food and stimulant for every fruit bearing plant, also for foliage. Flowering plants and vegetables. ¼ cwt. (14 lbs.) \$2.25, ½ cwt. (28 lbs.) \$4.25, ¾ cwt. (56 lbs.) \$8.00, 1 cwt. (112 lbs.) \$15.00.

Insecticides and Fungicides

NOTICE—Articles prefixed by star (*) cannot be sent by mail.

***Aphine.** For the destruction of the green, black and white fly, thrips, red spider, mealy bug, caterpillars, scale, etc. It is a combination of essential and ethereal oils, combined with nicotine in a readily soluble and available form and can be applied as a spray, wash or dipping solution. Qt. \$1.25, gal. \$3.50.

***Arsenate of Lead (Paste).** Kills all leaf-eating insects, like potato bugs, rose bugs, gypsy and brown-tail moths, caterpillars, elm beetles, etc., and sticks to the leaves. It is easy to apply and won't injure the most tender foliage. 1 lb. 40c., 5 lbs. \$1.75, 10 lbs. \$3.00, 25 lbs. \$7.00, 50 lbs. \$10.50, 100 lbs. \$18.00.

***Arsenate of Lead (Dry).** 1 lb. 50c., 4 lbs. \$1.50, 10 lbs. \$3.00, 25 lbs. \$7.00, 50 lbs. \$15.00, 100 lbs. \$27.00.

***Black Leaf 40 (Nicotine Sulphate).** Highly recommended by spraying experts for destroying all sucking and many chewing insects. 1 oz., 35c., ½ lb., \$1.25, 2 lbs., \$3.25, 10 lbs., \$11.85.



***Bordeaux Mixture, Paste.** A concentrated mixture. Ready for use by adding water, its value as a fungicide cannot be over-estimated; effective against black rot, mildew, rust, scab and all fungous disease. Prices: 1 qt. can 75c., 1 gal. can, \$2.25, 5 gal. can \$6.50.

***Bordeaux Mixture, Dry.** Can be used either dry as a dust or mixed with water as a spray for all fungous diseases. 1 lb. to 5 gals. of water. 1 lb. 40c., 4 lbs. \$1.25.

Bug Death. A non-poisonous powder. 1 lb. 25c., 3 lbs., 60c., 5 lbs., \$1.00, 12½ lbs., \$2.00.

Bye, Bye, Blackbird. A safe remedy for the user, but sure to rid corn fields of crows, blackbirds, etc. Harmless to plant life, but should not be brought in contact with the body. ½ pt., \$1.00; pt. \$1.50.

Carbola. A disinfectant used instead of whitewash. 5 lbs. 75c., 10 lbs. \$1.25, 50 lbs. \$5.00.

***Copper, Ammoniated Solution of.** A liquid fungicide, ready for use. Dilute at the rate of 1 qt. to 25 gals. of water, and spray lightly. Qt., \$1.50, gal., \$4.00.

***Creosote, Gypsy Moth.** For the destruction of the eggs of gypsy moth. Qt. 50c., gal. \$1.25, 5 gals. \$5.00.

Cattle Spray. Protects cattle and horses from flies. A sure preventive, easily applied with sprayer. Gal. \$1.50.

***Cyanogas (Calcium Cyanide).** "Grade A." Will destroy ants, rats, ground hogs, etc. Lb. can 75c.



***Cyanogas (Calcium Cyanide).** "Grade G." For greenhouse fumigation, garden insects and other pests. Lb. 75c., 5 lbs. \$3.00, 25 lbs. \$10.00. "A poison," cannot send by mail.

Derrisol. A safe, non-poisonous, contact insecticide for the control of aphids or plant lice, red spider, green fly, and many other soft-bodied sucking insects. Inexpensive and effective. Oz. 35c., ½ lb. \$1.20, lb. \$2.00, 2 lbs. \$3.00, 10 lbs. \$12.00.

***Fungine.** An infallible remedy for mildew, rust, wilt, bench rot and other blights affecting flowers, fruits and vegetables. It is equally effective under glass and out of doors. A sulphur composition which diluted with water contains no sediment and does not stain the foliage. One gallon makes fifty gallons spraying material. Pt. 75c., qt. \$1.25, gal. \$3.50.

Grape Dust. For destroying mildew on grape vines and trees affected with mold, mildew or rust mites. 5 lb. pkg. \$1.00.



Funtrogen. An effective and scientific preventive and remedy for mildew, black spot and many fungous diseases for Roses and other plants. ½ pt. 75c., pt. \$1.25, qt. \$2.00, gal. \$6.00.

***Lemon Oil.** A cheap, safe and effectual insecticide for all insects and soft scale, highly recommended for house plants. Dilute with water 30 to 50 parts. ½ pt. 40c., pt. 75c., qt. \$1.25, 2 qts. \$2.25, gal. \$4.00.

***Lime-Sulphur Solution.** Will completely destroy San José and other scale. A clear-colored liquid, free from all worthless sediment, and contains the highest percentage of lime and sulphur possible in solution, and if not exposed to the air will remain so a long time. Qt. 50c., gal. \$1.00, 5 gals. \$3.50, ½ barrel, about 30 gals, 50 gal. barrels. Price on application.

***Lime and Sulphur, Dry.** For dormant spraying of fruit; used for same purposes as Liquid Lime Sulphur, but is much easier to handle. Lb. 35c., 5 lbs. \$1.50, 10 lbs. \$2.50, 25 lbs. \$4.50.

Nico-Fume Tobacco Paper. (Registered). For fumigating greenhouses. Positively the strongest Tobacco Paper on the market. In special friction-top tins, sold as follows: 24 sheets \$1.25, 144 sheets \$5.00, 288 sheets \$8.75.

Nico-Fume Powder. For fumigating. 5 lbs. \$3.75, 10 lbs. \$6.85.

***Nico-Fume Liquid.** A nicotine solution of exceptional purity. Does not stain or injure blooms or leave a disagreeable odor. ¼ lb. 75c., 1 lb. \$2.00, 4 lbs. \$6.25, 8 lbs. \$11.50.

***Paris Green.** Strictly pure. ½ lb. 40c., lb. 75c.

Pyrethrum Insecticide (Agri-Pax). For harlequin bug, controls rose-bugs and soft bodied insects. Also used on celery, currants, etc. Non Poisonous. ½ pt. 40c., pt. 60c., qt. \$1.00.

***Pyrox, Bowker's, The New Improved.** The one best spray for all leaf-eating insects. Does all that arsenate of lead will do, besides protecting trees, shrubs, vegetables and plants against fungous diseases, one application answering both purposes, saving labor and expense. All ready to use by adding water. 1 lb. 55c., 5 lbs. \$2.00, 10 lbs. \$3.50, 25 lbs. \$7.25, 50 lbs. \$12.00, 100 lbs. \$18.00.

***Richard's X L All, Liquid Insecticide.** Destroys mealy bug, red spider, etc. Qt. \$3.00, ½ gal. \$5.50, gal. \$10.50.

INSECTICIDES AND FUNGICIDES—Continued

***Scalecide with Fungicide.** The most reliable, simple and economical remedy for destroying San José scale, mussel scale, brown scale, red scale, cottony maple scale and all other scale and soft-bodied sucking insects. Also all fungous diseases. Mixes instantly with cold water and stays mixed. Will not injure the trees. Qt. 85c., gal. \$1.85, 5 gals. \$7.00, 10 gals. \$12.00, 50 gals. \$40.00.

"Shade-O" for Shading Greenhouses. Pkt. \$1.25.

Slug Shot, Hammond's. Destroys insects injurious to house and garden plants, vegetables and fruit of all kinds. Directions for use on each package. 5-lb. pkg. 75c.

***Soap Spray, "Imp."** The base is pure soap. It contains vegetable poisons, harmless to plants, but peculiarly effective against red spider on fruits, etc., the rhododendron fly, rose bug and other insect pests on fruits, flowers and foliage. It sticks, but can be easily washed off before marketing. One gallon (can) makes 12 gals. of spraying fluid. Qt. \$1.00, gal. \$3.00, 5 gals. \$11.00, 10 gals. \$19.00. Specially recommended and very effective in killing white fly.



Soap, Fish Oil. Is a most effective, reliable, simple and cheap preparation for destroying San José scale, plant lice, and all sucking insects on trees, shrubs, plants, vines, Rose bushes, etc. Efficiency is increased by addition of tobacco extractive matter and potash. This preparation is highly recommended. Full directions for use on each package. 1 lb. box 45c., 5 lb. box \$1.50.

Soap, Sulpho Tobacco. A very effective insecticide for use on plants in the house or outside. 3 oz. cake 10c., 1/2-lb. cake 20c. each.

Sprayers and Pumps. See pages 89-90-92-102.

Sulphur Flour. Useful for fumigating, spraying mixtures, lice on plants or animals. Prevents mildew on Grape vines, bushes, etc. 1 lb. 12c., 5 lbs. 50c., 10 lbs. 85c., 25 lbs. \$2.00, 100 lbs. \$7.50.

***Sulpho-Nathol.** Of value as a disinfectant as well as an insecticide. Pt. 65c., gal. \$4.00.

***Thrip Juice No. 2.** Very effective in destroying thrips on Grapes, aphids, red spider, mealy bug, and other sucking insects. Qt. \$1.25, gal. \$3.75.

Tobacco Dust. For aphids, etc., on the foliage and around the roots. Lb. 12c., 5 lbs. 50c., 25 lbs. \$2.25, 50 lbs. \$4.00, 100 lbs. \$7.50.

Tobacco Stems. Small quantities, per lb. 5c., \$1.00 per bbl., large bales or cases, per lb. 4c.

***Vermine.** A soil sterilizer and germicide for all soil vermin, such as cut, eel, wire and grub worms, slugs, root lice, maggots and ants. Used in the greenhouse, garden and field. One part Vermine to four hundred parts water, thoroughly soaking the ground, does its work effectively without injury to vegetation, and protects your crops and lawns against the ravages under soil. Pt. 75c., qt. \$1.25, gal. \$3.50.

Volck. One of the most powerful insecticides known for the control of red spider and scale. Volck is non-poisonous. Must not be used in connection with lime or sulphur. Qt. \$1.00, gal. \$3.00, 5 gals. \$12.00, 14-gal. drum \$25.00.

Water Glass. For preserving eggs. One gallon makes sufficient solution for 50 dozen. Qt. 40c., gal. \$1.25, 5-gal. can \$4.50, 10-gal. can \$8.00.

***Wilson's O. K. Plant Spray.** Powerful yet harmless. A contact spray for Roses, Chrysanthemums, Carnations, Grape vines (when dormant), etc. 1 gal. \$3.00, 5 gals. \$12.00, 10 gals. \$20.00, 25 gals. \$50.00, 50-gal. bbl. \$90.00.

"HERBICIDE"
THE WEED EXTERMINATOR

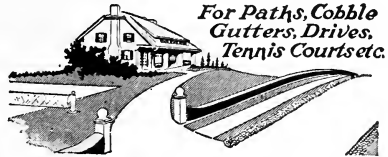

***Weed Exterminator, "Herbicide."** Is a powerful chemical solution for destroying weeds and vegetation of all kinds on roadways, paths, gutters and tennis courts. It is highly concentrated and each gallon may be diluted with 50 gallons of water. When the ground is drenched with the diluted material, both the tops and roots are destroyed.

Size of Package	Retail Price	Size of Package	Retail Price
1-qt. can	\$0.75	5-gal. can	\$7.50
1-gal. can	2.00	10-gal. can	12.50



Ever Green. Kills cutworms. Non-poisonous. Will not burn or injure the tenderest crop. Does not injure the soil in any way. Will not gum sprayers. Pleasant and easy to use. No unpleasant odor. When diluted Ever Green retains its strength indefinitely. To kill cutworms, use 1 part of Ever Green to 100 parts of water. Spray around plants, wetting ground thoroughly. Cutworms coming in contact with the solution will come to the surface and die. Keep ground around plants moist. Do not use soap. Ever Green can also be used to control aphids, leaf hoppers, cabbage worms, mealy bug, and many other insects, killing practically all sucking and

chewing insects. 1 oz. bottles, 35c.; 6-oz. bottles, \$1.00; 16-oz. bottles, \$2.00; 32-oz. bottles, \$3.50; gal. \$13.00 5 gal. keg, \$50.00. Special circulars giving detailed information mailed on request.

IMPORTED GRANULATED
PEAT MOSS
TORF  MULL

PEAT, LEAFMOLD, ETC.

Peat Moss (Imported.) Coarse and fine, \$4.00 per bale. Trial bale, \$1.50 each.

Silver Sand. For mixing with potting soil, etc. Pk. 50c., bu. \$1.50.

Leafmold. Best quality. Bag \$3.50.

Moss, Live Sphagnum. Bu. \$1.50, bag \$3.50.

Moss, Dry Sphagnum. Bag \$1.50. Small bale \$6.50, large bale \$10.00.

Orchid Peat, or Fern Root. Best selected. Hand-picked. Bag \$4.00.

Special Insecticides and Special Fertilizers



Antrol

The Antrol system kills ants in their nests. The species that infest the kitchen and eats food. Use Antrol for permanent quick relief.

- Antrol sets containing 4 containers and 1 4-oz. bottle of syrup.....\$1.00
- Antrol extra containers, each......15
- Antrol Syrup, 4-oz. bottle......50
- Antrol Syrup, pint......1.00
- Antrol Syrup, gallon......4.00



SNAROL

For cutworms, snails, slugs, etc. Simply broadcast Snarol on the ground under the flowers and plants. Water will not harm it.

- 1 lb.....\$0.50
- 3 lbs......1.00
- 15 lbs......3.75

ACME ALL 'ROUND SPRAY

For destroying blight and fungous diseases, controls sucking insects and destroys chewing insects in one application.

- 1/4 lb.....\$0.45 Lb.....\$0.90

STIM-U-PLANT

An all-the-year powerful and odorless fertilizer for every plant that grows. Each tablet wrapped in paraffined paper for protection. A trial will convince of its merit.

- 30 tablets.....\$0.30
- 100 tablets......75
- 1000 tablets.....Postpaid 3.50

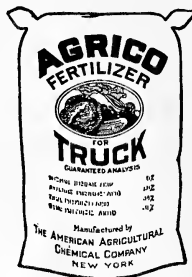

"Agrico" represents the best combinations of plant food for each crop that experience and science have so far produced. "Agrico" contains all the elements of plant food which have long been regarded as essential to the fertilization of crops as well as other elements which have not been so generally recognized.

"Agrico" plant foods are selected for crop producing power rather than for chemical analysis alone. Each grade is compounded and blended to provide, with the highest degree of efficiency. All the essential plant foods for each crop.

"Agrico" Fertilizer for Truck (5-10-5). Broadcast and harrow in from 1500 to 3000 lbs. per acre, according to the amount of manure used, and the requirements of the particular crop and soil. In case of crops that have a long season of growth, some of the fertilizer may be withheld and applied as a side-dressing after planting, or additional side-dressings may be made as required.

"Agrico" Fertilizer for Potatoes (4-8-6). Apply through the fertilizer attachment of Potato planter so constructed that the fertilizer is deposited on either side of, a little distance from, and slightly below the level of the "seed" pieces; or it should be applied in such a manner that the fertilizer is thoroughly mixed with the soil and not brought in contact with the seed pieces. Use from 1200 to 2000 lbs. per acre, according to requirements.

"Agrico" Fertilizer for Corn (3-10-6). Drill in at the rate of 150 to 200 lbs. per acre through the fertilizer attachment of the planter. The remainder of the fertilizer application should be applied broadcast and harrow in before planting. For best results, apply from 600 to 1000 lbs. per acre, or for Sweet Corn and silage Corn, even as much as 1200 to 1500 lbs. per acre.

"Agrico" Fertilizer for Grain (2-12-4). For the best results, this should be drilled in with the small grain at the time of planting by the use of a fertilizer attachment on the grain drill, at the rate of 200 to 400 lbs. per acre. If broadcasted, and harrowed in before seeding, the quantity employed should be one-fourth to one-third greater.

Write for prices and circulars

Practical Garden Books for the Amateur

We can supply any horticultural book in print. A few of outstanding value to the home gardener are here listed:

- 1001 Garden Questions Answered.** Prof. A. C. Hottes. Paper, \$1.65; cloth, \$2.15.
- Practical Landscape Gardening.** Robt. B. Criland. Cloth, \$2.65
- City and Suburban Gardening.** Chesla C. Sherlock. Cloth, \$2.15.
- Modern Dahlia Culture.** W. H. Waite. Cloth, \$1.65.
- A Little Book of Perennials.** Prof. A. C. Hottes. Paper, \$1.10; cloth, \$1.65.

- The Woman's Flower Garden.** Jane Leslie Kift. \$1.10.
- Foundation Planting.** Leonard H. Johnson. Cloth, \$3.65.
- Bulbs That Bloom in the Spring.** T. A. Weston. Paper, \$1.65; cloth, \$2.15.
- The Book of Shrubs.** Prof. A. C. Hottes. Cloth, \$3.15.

These books are well printed, illustrated with teaching pictures and durably bound. All prices postpaid.

INDEX—Continued

Page	Page	Page	Page
Poppies.....	Tarragon Plants.....24	Burning Brands.....85	Hose Menders.....87
42, 52, 53, 55, 74	Thunbergia.....60	Bush Hooks.....85	Hose Nozzles.....87, 88
Portulaca.....53	Timothy.....28	Bye, Bye, Blackbird 104	Hose Reducers.....87
Potato.....19	Tobacco.....23	Carbola.....104	Hose Reel.....8
Potentilla.....53	Tomato. VI, 22, 23, 24	Carnation Supports.85	Hose, Rubber, and
Primrose.....	Torenia.....60	Cattle Spray.....104	Cotton.....88
III, 50, 53, 54, 75	Trees, Deciduous.....81	Chains.....85	Hose Washers.....88
Primula. III, 53, 54, 75	Evergreen.....81	Charcoal.....103	Hotbed Mats.....88
Privet.....80	Fruit.....82, 83	Chrysanthemum	Hotbed Sash.....90
Prunus.....80	Ornamental.....81	Manure.....103	Insecticides 104, 105, 106
Pteris.....63	Tritoma.....60, 75	Clay's Fertilizer.....103	Knives.....88
Pumpkin.....19	Trollius.....60, 75	Coal Tar.....85	Labels.....88
Pyrethrum.....55, 75	Tropaeolum.....60	Copper Solution.....104	Lawn Boots.....88
Radish.....19, 20	Tuberose.....67	Corn Planter.....98	Lawn and Garden
Ranunculus.....55, 75	Tuberous Rooted	Cotton Wadding.....85	Dressing.....103
Rape.....28	Plants. 64, 65, 66, 67	Creosote, Gypsy	Lawn Mowers 93, 94, 95
Red Top.....27	Turnip.....23	Moth.....104	Lawn Sprinklers.....88
Reseda.....48	Valerian.....60	Cultivator, Nor-	Leaf Rack.....85, 92
Rhodanthe.....55	Vegetable Oyster.....20	cross.....86, 100	Leafmold.....105
Rhode Island Bent	Vegetable Seed Spe-	Cultivators, 86, 96, 100	Lemon Oil.....104
Grass.....27	cialties.....V-VI	Curry Cards.....86	Lime, Agricultural. 103
Rhododendrons.....80	Verbena.....III, 60, 68	Curry Combs.....86	Lime, Sulphur Solu-
Rhodotypos.....80	Veronica.....60, 75	Cyanogas.....104	tion.....104
Rhubarb.....20, 24	Vetches.....28	Derrisol.....104	Links, Lawn.....88
Rhus.....80	Viburnum.....80	Dibbles.....86	Manure Forks.....86, 87
Rhizinus.....55, 68	Vinca.....60, 68, 75	Dusters.....92	Manure Hooks.....88
Romneya.....55	Vines, Flowering.....76	Edging Knife.....86	Manure Spreader.....99
Roots and Plants.....24	Viola.....60, 61, 75	Electric Tape.....86	Mats.....88
Roses.....77, 78	Virginal Stock.....80	Evergreen.....105	Mattocks.....88
Rubus.....80	Viscaria.....61	Farm Garden and	Melon Nets.....88
Rudbeckia.....55, 75	Wallflower.....61	Lawn Requisites.....85	Mole Traps.....88
Rutabaga.....23	Watermelon.....14	Pen Pans.....102	Moss, Sphagnum.....105
Rye.....25	Weigela.....80	Fern Root.....86	Mower, Deering, etc.
Rye Grass.....27	Wheat.....25	Fern Root.....105	93, 99
Saintpaulia.....55	Whitlavia.....61	Ferules.....86	Mulford Cultures
Salpiglossis.....55	Wood Meadow Grass 28	Fertilizers.....103, 106	3d cover
Salsify.....20	Xeranthemum.....61	Fertilizer Sower.....98	Muriate of Potash. 103
Salvia.....	Yucca.....61	Fertilizer	Nico-Fume Paper
III, 55, 56, 68, 75	Zea.....61	Distributor.....98	and Liquid.....104
Sambucus.....80	Zinnia.....IV, 61, 68	Flower Pot Hangers.86	Nitrate of Soda.....103
Sanvitalia.....56		Flower Pots, Sau-	Oilers.....88
Saponaria.....56		cers, etc.....86	Oil, Harvester.....88
Satin Flower.....44		Forks.....87	Oil Skin Clothing 102
Saxifraga.....75		Fungicides 104, 105, 106	Orohid Peat.....105
Scabiosa.....III, 56, 75		Fungine.....104	Pails.....88
Schizanthus.....III, 56		Funtrogen.....104	Pails, Bulb and Seed 86
Schizopetalum.....56		Garden Lines.....87	Paper.....88, 89
Scidum.....56, 75		Garden Reels.....87	Paris Green.....104
Seeds for Wild Gar-		Garden Requisites. 85-	Peat.....105
dens.....62		102	Pencils, Indelible.....89
Sensitive Plant.....48		Gardener's Gloves	Picks, Contractors.....89
Shamrock.....56		87, 102	Plant Protecting
Shrubs.....79, 80		Gypsy Moth Creosote	Cloth.....89
Silene.....56	104	Cloth.....89
Small Fruits.....83, 84		Glass Cutters.....87	Plant Protectors.....89
Smilax.....57		Glazing Machines.....87	Plant Spray.....105
Snake-dragon, Alpine. 46		Glazier's Points.....87	Plant Sprinklers.....89
Solanum.....28		Goggles.....102	Plant, Tubs.....89
Solanum.....57		Grafting Knife.....87	Plants.....97
Specialties in Flower		Grafting Wax.....87	Post Hole Digger.....89
Seed.....I-IV		Grape Dust.....104	Post Hoe.....98
Specialties in Vege-		Grass Catchers.....95	Potato Hooks.....89
table Seed.....V-VI		Grass Hooks.....87	Pruners, Tree.....89
Spinach.....VI, 20		Grindstones.....87	Pumps, Auto Spray.89
Spirea.....75, 80		Grindstone Fixtures.87	Pulverized Poultry
Squash.....VI, 21		Hammers.....87	Manure.....103
Statice.....57, 75		Hand Cart, Box, etc. 92	Pumps, Pomona.....102
Stevia.....57		Handles.....87	Putty Bulb.....90
Stocks.....III, 57		Harrow.....96	Putty, Twemlow's.....90
Stokesia.....57, 75		Hatchets.....87	Pyrethrum Insecti-
Streptocarpus.....57		Hay Forks.....86	cide.....104
Sudan Grass.....28		Hay Tadders.....99	Raffia.....104
Sunflower.....28, 44, 72		Hay Rakes, Deer-	Rakes.....90
Swainsona.....57		ing, etc.....99	Rake, Hay.....90, 99
Sweet Clover.....57		Hedge Shears.....90	Richard's X L Ail. 104
Sweet Peas. IV, 58, 59		Hoes.....87, 98, 100	Rollers.....101
Sweet Vernal.....28		Hose Clamps.....87	Rope.....101
Sweet William.....		Hose Connection.....87	Rubber Boots.....102
59, 60, 71		Hose Couplings.....87	Rubber Gloves.....102
Symphoricarpos.....80			Salt.....103
			Sand, Silver.....105
			Sash, Hotbed.....90
			Savage Duster.....92
			Saws.....90
			Scalecide.....105
			Scissors.....90
			Scops.....90
			Scrapers, Steel Drag. 98
			Scythes.....90
			Seythe Snaths.....90
			Seythe Stones.....90
			Seed Drills.....100
			Seed Pans.....86
			Seed Sower.....90
			Seeder.....90, 100
			Shade-O.....105
			Shears.....90
			Sheep Manure.....103
			Shovels.....90
			Sickle.....87
			Silkline.....90
			Slug Shot.....105
			Snarl.....106
			Snow Pusher.....90
			Snow Scoop.....90
			Soap Sprayer.....92
			Soap Spray "Imp" 105
			Soap, Fish, Oil.....105
			Soap, Sulpho To-
			bacco.....105
			Sod Lifter.....90
			Soot.....103
			Spades.....90
			Spading Forks.....87
			Sprayers.....89, 92
			Spray Pumps.....89, 102
			Sprinklers.....88, 89
			Stake Fasteners,
			Eureka.....90
			Stakes.....90-91
			Sticks, Match.....91
			Stim-U-Plant.....106
			Stockbridge Ferti-
			lizers.....103
			Stone Boats.....99
			Styptic.....91
			Sulphate of Am-
			monia.....103
			Sulphur Flour.....105
			Su persp asptate, A.
			A.....103
			Sypho-Nathol.....150
			Tamper.....91
			Tape Lines.....91
			Tarred Yarn.....91
			Tedder, Hay.....99
			Thermometers.....91
			Tin Foil.....91
			Tobacco Dust and
			Stems.....105
			Tree Scraper.....91
			Thrip Juice.....105
			Trellises.....91
			Trowels.....91
			Trucks.....92
			Tubs, Plant.....89
			Twine.....91
			Tying Materials.....91
			Vermine.....105
			Volck.....105
			Vine and Plant
			Manure.....103
			Water Glass.....105
			Watering Pots.....92
			Wedges.....92
			Weeders.....91, 92, 98
			Weed Killer.....105
			Wheelbarrows.....85
			Wheel Hoe.....100
			Whiffletrees.....92
			Wire.....92
			Wrenches.....92

PARCEL POST RATES—SEE 2nd COVER PAGE

Mulford Cultures

FOR LEGUMES

Increase your Crops — Improve Your Soil

FOR SMALL SEEDS

½ bu.	\$0.60
1 bu.	1.00
2½ bu.	2.25
5 bu.	4.00

FOR LARGE SEEDS

1 bu.	\$0.60
2 bu.	1.00
5 bu.	2.25
10 bu.	4.00

Garden Size (Composite Culture for Garden Beans, Garden Peas, Lima Beans and Sweet Peas)\$0.25

To get the best returns from your legume crops, inoculate the seed with MULFORD CULTURES. They increase the yield and improve the quality. More nitrogen is drawn from the air by inoculated legumes than is used by the plant itself, thus they add nitrogen and humus to the soil for the benefit of the succeeding grain crops.

To maintain soil fertility every crop rotation should include legumes. Up-to-date farmers use inoculation. The best are MULFORD CULTURES.

The date on the package is your protection.

When ordering always state kind of seed you wish to inoculate.

Small Cost
Large Returns
Easy to Use
No Labor Expense

FREE DESCRIPTIVE
CIRCULAR
ON REQUEST

VIGORO

The Complete Plant Food

A complete fertilizer for lawns, vegetable gardens, and flower gardens. Greatly used on lawn courses.

PRICE

5-lb. bag	\$0.60
25-lb. bag	2.00
50-lb. bag	3.75
100-lb. bag	6.00

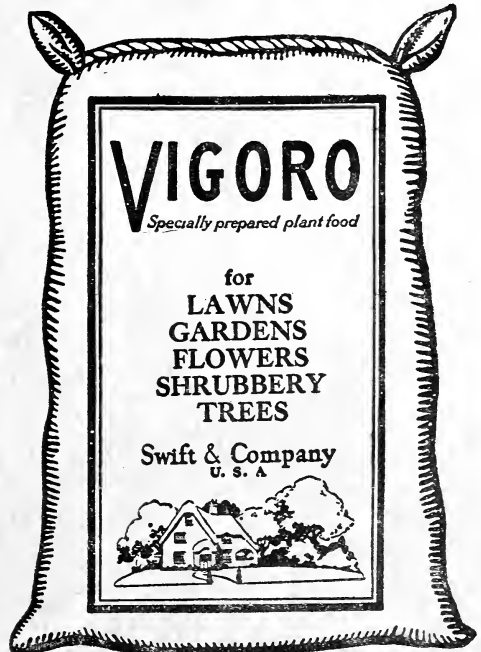

THOS. J.
GREY
CO.

16 SOUTH MARKET ST.
BOSTON · MASS.

